

Windmill Apartments

397 Windmill Road

Excavation and Building
Construction

Prepared by Geoff MacLean, P.Eng.

Job No. 37369

CONSTRUCTION MANAGEMENT PLAN

3	AUG 2024	REVISED PER NOISE BYLAW
2	JUL 2024	REVISED AS PER HRM COMMENTS
1	MAR 2024	ISSUED FOR PERMIT
0	FEB 2023	ISSUED FOR REVIEW
REVISION #	DATE	DESCRIPTION



36 Oland Crescent
Bayers Lake Business Park
Halifax, Nova Scotia B3S 1C6
www.sdmm.ca

t: 902-455-1537
f: 902-455-8479
c: 902-789-6374
e: gmaclean@sdmm.ca

Revisions Summary

Revision 1 – Sections; 1.1, 2.1, 2.2, 2.3, 5.1, 6.2, 7.6, 7.7 & 8.1, Appendices A, G, P, Q & R

Revision 2 – Sections; 1.1, 1.2, 2.1, 2.2, 4.1, 4.2, 5, 5.1, 6, 7.4, 7.6, 8.1, 8.2 & 8.3, Appendices A, B, C, D, E, G, L & P

Revision 3 – Section 2.3

Table of Contents

Section 1: Introduction	1
1.1: Project Description and Objectives	1
1.2: Project Contact Information	2
Section 2: Project Schedule and Logistics	2
2.1: Schedule	2
2.2: Key Dates	2
2.3: Hours of Work.....	3
Section 3 – Relevant Regulations & Guidelines	3
3.1: Occupational Health & Safety Regulations.....	3
3.2: Municipal Regulations & Guidelines.....	3
Section 4: Vehicle Management.....	4
4.1: Vehicular Traffic Control.....	4
4.2: Haul Route and Staging Areas	4
4.3: Vehicular Traffic Notifications	4
4.4: Emergency Vehicles.....	4
4.5: Parking	4
4.6: Bus Stops.....	4
4.7: Hazard Assessment.....	4
Section 5: Pedestrian Management	5
5.1: Pedestrian Protection	5
5.2: Pedestrian Safety.....	5
5.3: Pedestrian Traffic Notifications	5
5.4: Visually Impaired Persons.....	5
5.5: Accessibility	5
5.6: Hazard Assessment.....	5
5.7: Pedestrian Management Plans Rendering (PMPR) Signage	6
5.8: Pedestrian Detour Wayfinding Signage	6
Section 6: Encroachments & Disruptions	6
6.1: Demolition	6

6.2: Site Excavation.....	6
6.3: Site Services Connection.....	6
6.4: Construction Management Plan Element Inspection and Maintenance.....	7
6.5: Changes to the Construction Management Plan.....	7
Section 7: Environmental Factors.....	7
7.1: Damage to HRM Infrastructure	7
7.2: Protection of Trees	7
7.3: Line Painting and Temporary Crosswalks	7
7.4: Street and Right-of-Way Cleaning	7
7.5: Protection from Inclement Weather	8
7.6: Storm Water Management.....	8
7.7: Noise, Dust and Emission Control.....	8
7.8: Rodent Control	8
Section 8: Site Protection & Hoarding.....	9
8.1: Barriers & Fences.....	9
8.2: Snow removal	9
8.3: Gate Access and Egress.....	10
8.4: Hoarding Aesthetics.....	10
8.5: Sight Lines.....	10
8.6: Project Information and Contacts	10
Section 9: Lifting, Hoisting, and Crane Operations.....	10
9.1: Crane Use Overview	10
9.2: Transport Canada and Nav Canada Regulations.....	11
9.3: Aerodromes	11
Section 10: On-Site Safety and Security	11
10.1: Site Safety and Security Overview	11
10.2: Material Handling: Loading, Unloading, Delivery and Storage.....	11
10.3: Emergency Access & Egress.....	11
10.4: Security Site Lighting	12
10.5: Smoking Areas	12
10.6: Fire Suppression Systems	12
Section 11: Pre-Construction Consultation & Meeting	12

11.1: Pre-CMP Community Consultation.....12

11.2: Project Information and Contacts12

11.3: Preconstruction Meeting.....12

11.4: Construction Notification12

Section 12: Summary.....13

Appendix A – Encroachment Plan..... A

Appendix B – Traffic Control Plans TCPB

Appendix C – Haul Route PlanC

Appendix D – Pedestrian Management Plan (PMP) D

Appendix E – Barrier, Fence & Gates Information.....E

Appendix F – Hoarding Information F

Appendix G – Project Information Board G

Appendix H – Project Safety Signage H

Appendix I – Project Signage SpecificationsI

Appendix J – Sample Traffic Notification Letter J

Appendix K – Vehicular and Pedestrian Hazard AssessmentK

Appendix L – Community Consultation Records L

Appendix M – HRM Tree Detail M

Appendix N – Rodent Control Plan N

Appendix O – CMP’s TCP & PMP Inspection Records..... O

Appendix P – Concrete Delivery Schematic.....P

Appendix Q – Crane Information.....Q

Appendix R – Line Painting Schematic.....R



Prepared by

G.K. MacLean, P. Eng.

In consultation with the Developer, contractor,
traffic control company and HRM.

Section 1: Introduction

1.1: Project Description and Objectives

The developer is planning to construct an apartment building on their vacant land located at 397 Windmill Road in Dartmouth. The planned development will include 60 residential units within 10-storey building and 2 levels of underground parking accessed from Windmill Road. This CMP has been prepared to address excavation, services and building construction.

Where the building is planned to be within 5m of HRM's Right-of-Way (ROW) while having two levels of underground parking, deep excavations (+20ft) incorporating the ROW are required for the project. The building is set near 2.5m (8ft) from the ROW, with this limited space on private property for public safety during excavation and construction the project is planned to incorporate portions of the HRM ROW along Windmill Road. The project is planned in phased encroachments to minimize impacts to the surrounding community. During initial site excavation stage (phase 1), no ROW encroachments are anticipated leaving the sidewalk on Windmill Road in front of the project open to the public. Site excavation and foundation (Phase 2) this will close the sidewalk to the public fronting the project site, and during the final building construction (Phase 3) the encroachment will be increased to include a portion of the street lane for a truck layby, this will alter the street centerline. These encroachments will close the public sidewalk directly in front of the project to pedestrians redirecting them to the opposite side of the street and require alteration to the yellow centerline, while maintaining two-way vehicle, truck & bus traffic on Windmill Road. Only during service work do we anticipate short term temporary lane drops. It is anticipated that the crane assembly will reside within the encroachment and private property, while the crane disassembly may require a temporary lane drop.

The project borders a commercial property that houses "Eastward Energy Town Border Station" along its western and southern property lines, vacant crown land housing an overhead transmission wire corridor along its northern property line and to the east across Windmill Road is a residential property and commercial building that houses "Ship Victory Restaurant & Lounge". Neighbouring properties will remain undisturbed throughout all construction phases and all neighbours will be notified and updated on construction ahead of time.

This CMP document is intended to be an evolving document to help guide the project team to mitigate impacts to the adjacent community before they arise and to address unforeseen issues. SDMM, together with the developer, contractor, and traffic control company, have prepared this Construction Management Plan (CMP) following HRM's CMP (2020) guidelines and administrative order (2018-005-ADM) in an effort to reduce potential negative impacts on the surrounding community, due to construction activities for this project.

The most up-to-date version of this document will be kept on-site at all times during construction. Should ownership or contracting services change throughout the course of this project, HRM will be notified immediately, and new parties will be required to comply with the approved CMP in writing.

1.2: Project Contact Information

The project team for the proposed development consists of:

Role	Name	Contact	Address	Phone
Developer	3309758 Nova Scotia Limited	Saad (Sam) Massan	2 Samuel Terrace, Halifax, NS, B3N 3A2	(902) 456-3297
Construction Manager	Antler Construction	Adam Wicks	57 Polara Drive, Lower Sackville, NS B4C 2B7	(902) 388-6032 24 Hour Emergency Contact
Site Contractor	Atlantic Road Construction and Paving	Greg MacDonald	6 Belmont Avenue, P.O. Box 89 Eastern Passage, NS B3G 1M7	(902) 830-6411
Traffic Control Company	Frontline Traffic Services	Phil Pruneau	6 Belmont Avenue, P.O. Box 89 Eastern Passage, NS B3G 1M7	(902) 818-5548
Rodent Control Company	Rentokil Pest Control	Main Office	51 Duke Street, Bedford, NS B4A2Z2	(902) 835-2304

Section 2: Project Schedule and Logistics

The following is a brief summary of anticipated major project milestones broken down by phase:

2.1: Schedule

Project Phase	Start Date		End Date	Time Period
Rodent Control Program	Jul 15, 2024	-	Oct 15, 2024	3 months
Demolition	n/a	-	n/a	-
Site Excavation	Aug 1, 2024	-	Oct 31, 2024	3 Months
Footings and Foundations	Oct 1, 2024	-	Feb 28, 2025	5 Months
Superstructure	Feb 1, 2025	-	Jun 30, 2026	17 Months
Service Abandonments	Aug 1, 2025	-	Aug 29, 2025	1 week
Service installs	Aug 1, 2025	-	Aug 29, 2025	2 weeks
HRM Right of Way Flat Works	Sep 19, 2025	-	Sep 30, 2025	2 weeks
Site Flat Works	Oct 25, 2025	-	Oct 30, 2025	1 week

2.2: Key Dates

- Take-over encroachment August 1, 2024
 - Sidewalk closure (Windmill Road)
 - Street lane encroachment (Windmill Road)
- Finish encroachment June 30, 2026
- Duration of encroachment 21 months
- Temporary lane/road closures:
 - Windmill Road service abandonments August 9-10, 2025
 - Windmill Road Water service install August 16-17, 2025
 - Windmill Road Sewer service install August 23-24, 2025
 - Windmill Road new storm main extension install August 25-29, 2025

The encroachment areas are shown in the appendix for reference.

2.3: Hours of Work

Work will generally take place during normal working hours as outlined in HRM’s Noise By-Law and Traffic Control Manual Supplement; these are noted below.

- Monday to Friday: 7:00 a.m. – 8:00 p.m.
- Saturdays: 8:00 a.m. – 7:00 p.m.
- Sundays & Statutory Holidays: 9:00 a.m. – 7:00 p.m.
- Servicing Work: Noted Above

Although work is not expected to be required outside of the times listed above, if, for any reason, work is anticipated to be required outside of these hours, the contractor will apply to HRM for approval 5 business days (minimum) in advance of such work and obtain approval prior to proceeding. It is noted that HRM’s Noise By-Law cannot be altered without HRM council approval; work must adhere to the Noise By-Law. Note that construction noise exemptions may be granted where construction noise is planned to take place during prohibited hours of the N-200 By-law. The developer to apply for this separately under the Construction Noise Exemption process.

Section 3 – Relevant Regulations & Guidelines

3.1: Occupational Health & Safety Regulations

This CMP shall be utilized in agreement with all applicable Provincial and Federal Occupational Health and Safety Regulations. At a minimum, construction activities must at all times meet the standards of:

- a) National Building Code of Canada, as adopted and modified under the Building Code Act and the Nova Scotia Building Code Regulations made under that Act;
- b) Nova Scotia Occupational Health and Safety Act, and the Nova Scotia Occupational Safety General Regulations made under that Act;
- c) The Transportation Association of Canada (TAC)’s Manual of Uniform Traffic Control Devices for Canada (MUTCDC); and
- d) Nova Scotia Temporary Workplace Traffic Control Manual (NSTCM).

3.2: Municipal Regulations & Guidelines

In addition to the Provincial and Federal standards referenced in Section 3.1, this CMP shall be utilized in agreement with and meet, at a minimum, the standards of all relevant municipal by-laws including, but not limited to, the following:

- a) HRM Design Guidelines;
- b) HRM Standard Details;
- c) S-300 Streets;
- d) E-200 Encroachments;
- e) B-201 Building;
- f) N-200 Noise;
- g) T-600 Trees;
- h) S-900 Controlled Access Streets;
- i) T-400 Truck Routes;
- j) W-101 Discharge into Public Sewers;
- k) B-600 Blasting;
- l) HRM TCM Supplement;
- m) G-200 Grade Alteration and Stormwater management;
- n) Admin Order 2018-005-ADM regarding encroachments; and
- o) Admin Order 2020-010-OP regarding stormwater management standards for development activities.

Section 4: Vehicle Management

Prior to any construction activity, all temporary workplace traffic control devices and signage will be in place as per the Nova Scotia Temporary Workplace Traffic Control Manual (latest edition). The traffic control company will install the signage and ensure that they are maintained throughout the project. This project's Traffic Control Plans (TCPs) are listed in the Appendix.

4.1: Vehicular Traffic Control

A Traffic Control Plan (TCP) has been prepared by the traffic control company and is provided in the Appendix.

We are proposing an altered centerline along Windmill Road, to accommodate the phase 3 layby encroachment, two-way vehicle traffic will be maintained with a 4.0m wide southbound travel lane passing the encroachment. The existing 4.38m wide northbound travel lane will remain as is. Only during service work do we anticipate short term temporary lane closures. It is anticipated that tower crane assembly will be stationed within the encroachment area and on private property while disassembly may require a temporary lane drop. Please refer to the appendices for required encroachment plan and traffic control plans.

4.2: Haul Route and Staging Areas

The truck Haul Route Plan has been prepared by the traffic control company and is provided in the appendix.

The selected route is intended to minimize traffic congestion and maximize pedestrian safety. During all construction phases vehicles will enter and exit the site at the gate location(s) which will be clearly marked for function. During construction activities concrete and material deliveries shall be contained within private property and the encroachment. We anticipate these deliveries entering and exiting gates on Windmill Road with traffic flow. Refer to appendix for concrete delivery schematic.

4.3: Vehicular Traffic Notifications

Should any traffic disruptions be required, notifications will be distributed to properties in the impacted area a minimum of five (5) days in advance of vehicular traffic closures. Refer to sample notification letter in the appendix.

4.4: Emergency Vehicles

In the event of unforeseen emergency situations, the site will remain accessible to emergency vehicles at all times.

4.5: Parking

On street parking will not be affected by this project as un-metered parking is not permitted directly in front or in the vicinity of the project site. It is noted that passenger vehicles are not permitted to park within any encroachment areas. To minimize parking requirements in adjacent neighbourhoods, site workers will utilize private property and workers will be encouraged to carpool or rely on public transit.

4.6: Bus Stops

Bus service travels along Windmill Road with a bus stop directly across the street from the project and one near the Fernhill Drive intersection. Bus service should not be affected by this project.

4.7: Hazard Assessment

A vehicular and pedestrian hazard assessment is provided in the appendix. Any additional site hazards identified or encountered after work has commenced will be added to this list. All personnel on-site will be required to review this list and encouraged to identify additional potential hazards and hazard mitigation methods.

Section 5: Pedestrian Management

A Pedestrian Management Plan (PMP) has been prepared by the traffic control company and is provided in the appendix.

Throughout excavation and foundation phase 2 and building construction phase 3, the project will close the sidewalk in front of the development. This is to ensure construction and deliveries are kept a safe distance from pedestrians. Pedestrian traffic will be maintained with use of the existing sidewalk on the opposite side of the street and existing adjacent crosswalks.

5.1: Pedestrian Protection

Pedestrians will be protected by physically distancing them from the project. A combination of rigid construction fencing, and F-type concrete jersey barriers with chain link fencing mounted above will delineate the project. All fencing will be covered with opaque covering that extends a minimum 3m from the public right-of-way to block view of the site. Refer to the appendix for examples of the barriers and fencing.

5.2: Pedestrian Safety

Pedestrian safety will be maintained by implementing appropriate signage as shown on the PMP. All navigation and safety signage indicating alternative sidewalks and potential hazards will be inspected and maintained regularly.

5.3: Pedestrian Traffic Notifications

Notifications will be distributed to properties in the impacted area a minimum of five (5) days in advance of pedestrian traffic impacts. A sample traffic notification letter can be found in the appendix. HRM must be notified prior to issuing the notification to neighbours.

5.4: Visually Impaired Persons

In keeping with CNIB requirements and as outlined on their 'Clearing Our Path' website; various items will be incorporated into the pedestrian management signage and barriers. Such as, high visibility contrasting colours with appropriate font types (mix of upper and lower-case lettering), font sizes (between 16mm to 51mm) and sign colours (orange background with black lettering or white background with black lettering).

The contractor will use bright orange sawhorse barricades complete with bold-font signage to identify sidewalk termination points. Sawhorse barriers will incorporate lower cross members, painted and marked consistent with the rest of the sawhorse, these added cross members will be placed near the ground to aid visually impaired persons using a cane. Reflective tape will also be placed on the ends of fencing, hoarding, sawhorse barricades, and concrete barriers to help delineate pedestrian routes and disruptions. Signage and tape colours will vary but will comply with the colour/brightness contrast as outlined by the CNIB website; examples are black/white, orange/black or dark red/white combinations.

5.5: Accessibility

High visibility signage will be used to assist pedestrians to easily navigate around all project related blocked sidewalks.

5.6: Hazard Assessment

A vehicular and pedestrian hazard assessment is provided in the appendix. Any additional site hazards identified or encountered after work has commenced will be added to this list. All personnel on-site will be required to review this list and encouraged to identify additional potential hazards and hazard mitigation methods.

5.7: Pedestrian Management Plans Rendering (PMPR) Signage

The need for a rendered map displayed for pedestrians showing the detoured pedestrian routes is not anticipated for this project.

5.8: Pedestrian Detour Wayfinding Signage

The need for pedestrian wayfinding signage directing pedestrians to adjacent businesses is not anticipated for this project.

Section 6: Encroachments & Disruptions

Throughout construction this project is proposing phased encroachments along Windmill Road. During excavation and foundation (phase 2) the project will incorporate the sidewalk directly in front of the project, and during building construction (phase 3) we are proposing to incorporate the sidewalk and portion of the street lane to accommodate a truck layby. This will alter a portion of the street centerline and move pedestrians to the opposite side of the street with use of the existing Nootka Avenue and Fernhill Drive crosswalks. This encroachment is to keep the public away from the excavation zone of influence as well as provide additional space for site workers and deliveries within the encroachment area.

These encroachments are planned to be delineated by interlocking F-type concrete barriers complete and chain link fencing with opaque coverings.

Throughout the project, fencing will be positioned to not obstruct vehicle sight lines. In areas adjacent to the site gates open mesh chain link fence on top of the site barriers to not obstruct sight lines.

Should any utility or traffic disruptions be required, the contractor will first apply to HRM for approval, a minimum of five (5) business days in advance of such work and will then notify neighbours of these disruptions in a timely fashion.

6.1: Demolition

Building demolition is not required for this project. This CMP does not speak to demolition.

6.2: Site Excavation

This includes deep excavation and removal of common site material. The development is planned to have 2 levels of underground parking below street grade. If bedrock is found, the contractor will apply for a blasting permit and adhere to the HRM blasting by-law and conditions of the blasting permit. Alternatively, if a blasting permit can not be obtained the site's bedrock will be broken by a series of rock breakers to reach footing elevation.

6.3: Site Services Connection

This includes installation of new water sewer laterals to their respective mains, a new storm main extension within the street Right of Way (ROW), as well as decommissioning existing laterals which will be abandoned. The service installs will require modifications to the encroachment with temporary workplace signage incorporated (refer to the Service Installation Traffic Control Plans (TCP) in the appendix). HRM requires that this service work be limited to weekends only to minimize traffic disruptions. The target dates for this work are provided in the "Key Dates" section above with time of installations adhering to the Noise By-Laws noted above. The intent will be to complete this servicing work and reinstate the street as quickly as possible in order to minimize disruptions to the public.

Before scheduling site services connections, the contractor will notify all neighbouring properties, of the intended timeline for this work. A sample notification letter is included in the appendix.

The contractor intends to reinstate the street cut during the season of work. It is noted that street cuts cannot be left gravel or open. HRM reinstatement specifications must be met, and the travel way must be hard surfaced prior to reopening to the public. Asphalt, concrete curb and sidewalk reinstatement must be completed within 72 hours of disturbance and will be considered temporary if reinstated after October 31st or prior to May 1 in which case permanent reinstatement will be completed by June 15.

6.4: Construction Management Plan Element Inspection and Maintenance

Construction management plan elements will be inspected daily to ensure continued adherence to this CMP. Any deficiencies identified will be reinstated immediately. A CMP's TCP & PMP inspection report summary will be completed for the project, including information on what maintenance activities were conducted. This report must be kept on site at all times and be available to HRM upon request.

6.5: Changes to the Construction Management Plan

All departures from the CMP regardless of the significance must be submitted to the Municipality 10 days in advance for review and approval. Any required changes or modifications to the approved CMP will be submitted to HRM for review and approval prior to implementation.

Section 7: Environmental Factors

7.1: Damage to HRM Infrastructure

Existing HRM infrastructure will be reinstated within the encroachment area and/or be completely replaced. This includes reinstatement of the HRM sidewalk, curb and gutter and topsoil and sod post construction. It is anticipated that sidewalks across the street will not be impacted by excavation or other construction activities. However, while efforts will be made to avoid damage, it is anticipated that additional portions of existing curbs, gutters, and sidewalks may become damaged during the construction process which would require repairs or replacement. Pending HRM's review prior to and after construction and subject to damage due to construction activities, the developer acknowledges that items may require to be fully replaced rather than repaired. The developer also acknowledges that any costs incurred to repair or replace this public infrastructure are the responsibility of the owner. For reinstatement timeline requirements, it is noted that asphalt, concrete curb and sidewalk reinstatement must be completed within 72 hours of disturbance and will be considered temporary if reinstated after October 31st or prior to May 1 in which case permanent reinstatement will be completed by June 15 of the following construction season.

7.2: Protection of Trees

There are no HRM street trees within the public right-of-way directly in front of the project site. It is noted that HRM street trees shall not be touched prior to approval and/or compensation agreements between the developer and HRM Urban Forestry are in place. Adjacent street trees are to be protected during construction in accordance with the HRM Tree Bylaw (T-600). Refer to HRM tree protection detail in the appendix.

7.3: Line Painting and Temporary Crosswalks

An altered centerline is proposed for this project. Refer to the line painting schematic in the appendix.

7.4: Street and Right-of-Way Cleaning

The portion of public street adjacent to the project will be cleaned daily of any debris from trucks and silt, dirt, or rock that migrates beyond the encroachments. A sweeper truck will be utilized as required. Rock pads will be installed and maintained at all site entrances behind the curb line to knock dirt free from truck tires with aim to reduce off tracking of site soils.

Where the developer plans to utilize the street as a part of their encroachment the developer is responsible to clear snow from the street side of these jersey barriers, gates, and along edge of fencing directly adjacent to the public sidewalk.

7.5: Protection from Inclement Weather

To protect the public from construction debris during inclement weather, the project site will be enclosed by fencing complete with dust control covering, the site will be regularly reviewed and cleaned, with loose items secured when not in use.

7.6: Storm Water Management

During construction, nearby catch basins may be fitted with silt bags and/or filter fabric to prevent debris from entering the storm system and maintained until final reinstatement is complete. Stormwater collected inside the project site will be directed to temporary stormwater settling ponds situated within the building footprint to allow clean water to be pumped into the existing public wastewater sewer system. Dewatering to municipal systems require a permit from Halifax Water via p2@halifax.ca, and must be follow the strict adherence to Halifax Water regulations. The contractor must prevent erosion or siltation of surface runoff from leaving the construction site through the use of erosion and sedimentation controls (See NSECC Erosion and sedimentation control handbook for construction sites). Sediment ponds may be shifted and positioned as desired by the site contractor during mass excavation however will generally be placed in localized low points within the building excavation.

7.7: Noise, Dust and Emission Control

The contractor will at all times adhere to the HRM Noise Bylaw (N-200) unless approved under HRM exemption process. No work will take place on the project site outside those hours identified in section 2 of this report, unless HRM grants an exception.

Dust mitigation for this project will be achieved using rock pads for trucks exiting the site. A water truck and sweeper truck will also be utilized to help prevent dust from becoming airborne and, when required, calcium may need to be used to mitigate dust migration. Additionally, mesh on the inside of the fencing will help to contain any airborne dust inside the site.

Breaking of rock may occur and rock faces cleared to form a wall. Mesh will be used on the inside of all construction fencing to mitigate dust control.

All construction vehicles will be required to use the loading area for parking and idling to keep exhaust emissions within the construction zone. Vehicles will be staged so that idling will not occur for more than 3 minutes at a time.

As indicated above, all work shall be completed in accordance with the HRM Noise By-Law.

7.8: Rodent Control

Rodent movement increases during construction activities. The owner has engaged a rodent control company, to utilize the established Rodent Control Plan (RCP) to help mitigate rodent movement prior to and during site excavation and building construction. The RCP applies to all project phases with the goal of preventing movement of rodents off-site. The RCP will consist of a baiting and monitoring program. Bait stations (traps) will be placed as outlined in the NPMA Pest Management Standards for Food Processing & Handling Facilities.

The RCP was engaged two weeks prior to the commencement of site excavation to help to lower the number of active rodents in the project area. Bait stations positioned along existing buildings and fence lines prior to excavation. Bait

stations positioned along the edges of the project and secured in place using wooden stakes (for open sodded and dirt locations), weighted patio stones (behind walls and on paved areas), and zip-ties (fixed to fences) as per typical industry standards.

Refer to the appendix for a copy of the Rodent Control Plan.

Section 8: Site Protection & Hoarding

8.1: Barriers & Fences

Throughout construction, the project site and encroachment will be delineated using a combination of rigid fencing and interlocking F-type concrete jersey barriers complete with chain link fencing with a total height (concrete barrier and fencing structure) being 1.8m or 6ft as per the noted administrative order. All fencing will be covered with an opaque dust control mesh of high quality which will extend a minimum 3m from the public right-of-way. This screening is described in the appendix and will block passersby or tourists view of the construction site. Throughout the project, fencing and / or screening will be situated to not obstruct vehicle sight lines.

Along the private sidelines where non-vehicular traffic is present, the hoarding will be delineated by weighted modular 1.8m (6ft) high fencing or existing fencing where it is at least 1.8m tall. All fencing will have opaque dust control mesh and must be anchored down to prevent unintentional movement or overturning due to snow or wind loads.

The F-type barriers and fencing that define the encroachment will adhere to the Encroachment Plan which is to scale includes dimensions and can be found in the appendix. These areas can be measured for the administering of applicable fees. Encroachment areas and fees will be based on the areas within the public right-of-way enclosed by the barriers and fencing.

Installation of F-Type concrete barriers, fencing and covering will take place during regular working hours as noted above. This work will be scheduled by the contractor after the HRM's pre-construction meeting has been held. HRM will coordinate this pre-construction meeting; the developer, contractor and traffic control company will attend this site meeting. During the process of erecting and tearing down the traffic barriers, fencing and opaque covering defining the encroachment, traffic control elements will be implemented as per the Traffic Control Plan(s) in the appendix. All work and any traffic interruptions will be coordinated by the contractor who will notify HRM a minimum of 5 business days before work is scheduled to begin.

It is noted that surplus fencing must be stored and installed from private property when relocated for deliveries and be routinely re-established to keep the site secure. Surplus fencing cannot be stored within HRM's right-of-way.

8.2: Snow removal

The developer will be responsible to remove snow and ice as required to ensure that emergency access is maintain to the project site, this includes fire hydrants. The contractor will not dump snow or ice onto adjacent property and will truck snow off site as required to prevent the unsafe build-up of snow piles.

The contractor will clear snow from outside the jersey barriers to keep the edge of the vehicle travel lane clear of snow and ice build up, including gates and fencing along Windmill Road.

8.3: Gate Access and Egress

The site will be accessible through gates. These gates are the only locations that will receive equipment/materials during construction, gates will remain closed and will be locked at all times after work hours. In cases of emergencies, on-site workers will exit the project site through these gates. These gates will remain unlocked at all times when workers are on site in case of emergency allowing unrestricted emergency response units access to the site.

The project is planned to have two (2) access gates throughout all phases of construction. Construction access gates are planned to be stationed at the existing driveways along the street line (phase 1), at the existing driveways behind the curb line (phase 2), and each end of the Windmill Road truck layby (phase 3) encroachment to facilitate deliveries.

Any existing fire hydrants located adjacent to the site will remain protected from construction activities. These fire hydrants, along with the existing fire department connections will be accessible to firefighters throughout all phases of the project. Adjacent existing hydrants and fire department connections are not anticipated to be affected by construction.

8.4: Hoarding Aesthetics

The site hoarding will resemble that shown in the appendix; encroachment fee reductions are not anticipated.

8.5: Sight Lines

Rigid fencing and signage will be installed as per the CMP drawings such that vehicle sight lines are maintained around corners, particularly at driveway access points and existing intersections.

8.6: Project Information and Contacts

To encourage communication between the project team and the public, contact information will be provided on Project Information Boards; these will be posted prominently around the project site on the fencing; refer to the appendix for a copy of the Project Information Board and the Encroachment Plan for the planned locations. Refer to the signage specification within the appendix describing the required size, materials, mounting hardware, etc. of these signs.

Section 9: Lifting, Hoisting, and Crane Operations

9.1: Crane Use Overview

This project will incorporate a tower crane, the crane will be stationed within the project site and will be operated under the direct supervision of a licensed crane operator employed by the formwork contractor. The approximate location of the site's tower crane is shown in the appendix.

It is anticipated that the crane assembly will be stationed from private property or and within the encroachment area. Disassembly may require a temporary lane drop.

The crane swing will extend over neighbouring properties as shown in the Crane Swing Diagrams included in the appendix. The developer will notify adjacent property owners prior to extending the crane over their properties. Refer to the appendix for crane information.

Depending on the stage of construction, delivery & concrete pump trucks will be stationed within the encroachment area or on private property during concrete operations (see concrete delivery schematic within the appendix).

If lifting operations are required over the public realm, this area will be closed to access. In all cases of lifting, extreme care will be used to ensure public and worker safety.

9.2: Transport Canada and Nav Canada Regulations

There are two registered aerodromes in the Halifax region; Halifax International Airport and Canadian Forces Base Shearwater Airfield. According to Transport Canada regulations, the project site is outside of the lands to which regulations for these two aerodromes apply.

9.3: Aerodromes

There are several heliport approaches in the Halifax region; both Emergency Hospitals (QEII and IWK) as well as Point Pleasant Park. Given the location of the project site relative to these various approaches we understand Transport Canada notice does not apply.

Section 10: On-Site Safety and Security

10.1: Site Safety and Security Overview

The contractor will adhere to all Occupational Health & Safety requirements throughout the completion of this project. At a minimum, the following safety protocols will be utilized to further enhance site safety and security:

- a) All workers will be required to have proof of up-to-date safety training;
- a) Personal protective equipment (PPE) will be required for all personnel on site;
- b) Adequate signage will be placed outside the hoarding, which will warn of hazards that may exist;
- c) Gates will be locked and the perimeter fencing secured to provide security against public access during off work hours and will be monitored during operation;
- d) Hoarding will clearly state “No Trespassing – Construction Personnel Only” & PPE requirements will be clearly identified (e.g., “Hard Hats and Safety Footwear Must Be Worn Beyond This Point”);
- e) Regular safety inspections will be conducted to ensure suitability of hoarding and other safety devices;
- f) Emergency contact information to be prominently posted as per the Project Information Board.

10.2: Material Handling: Loading, Unloading, Delivery and Storage

The contractor will adhere to the procedures stipulated in the Haul Route Plan for delivery of materials. Delivery vehicles will use the designated gates for entry and exit. Timing of deliveries will be coordinated to have the least possible negative impact on regular traffic. The staging and delivery area will be coordinated by the delivery companies and site personnel, concrete and material delivery trucks will be housed within encroachment area or private property accessed from Windmill Road.

10.3: Emergency Access & Egress

The site will be accessible through gates to facilitate construction vehicle access. In cases of emergencies, on-site workers will exit the project site through these gates. These gates will remain closed but unlocked at all times when workers are on site in case of emergency allowing unrestricted emergency response units access to the site. Gates will be locked and secured afterhours to provide security against public access during off work hour. Emergency contact information will be posted on project information boards surrounding the site, refer to the CMP plan for details.

Gates are to remain closed at all times unless being used for deliveries to maintain a controlled access site preventing access by the general public to the construction site.

10.4: Security Site Lighting

Security site lighting is not anticipated for this project.

10.5: Smoking Areas

On site smoking areas will not be provided as this will be a smoke-free site.

10.6: Fire Suppression Systems

There are two existing fire hydrants on Windmill Road, one fronting civic 402 pass Nootka Avenue and one on the corner of Windmill and Fernhill that remain outside the project area and will be protected from construction activities. These fire hydrants, along with any existing fire department connections will be accessible to firefighters throughout all phases of the project.

The proposed fire department connection and fire hydrant are not available for fire department use until after the water supply lines have been installed, tested and commissioned by the water commission, similar with the fire suppression system. This system will not be active until after the building is near complete and the encroachment fencing has been removed.

Section 11: Pre-Construction Consultation & Meeting

11.1: Pre-CMP Community Consultation

Due to the current pandemic, the developer will forego the community consultation meeting. A construction notification letter will be delivered to the properties neighbouring the construction site as well as HRM staff, notifying them of the expected work with contact information for questions and feedback. As part of this notification the surrounding community and businesses will be offered to sign up for a monthly construction project notification from the development. It is understood, HRM requires a confirmation letter from the applicant confirming delivery of notification letters to affected residents. A map indicating these properties has been included in the appendix.

11.2: Project Information and Contacts

To encourage communication between the project team and the public, contact information will be provided on Project Information Boards; these will be posted prominently around the project site on the fencing; refer to the appendix for a copy of the Project Information Board and the CMP Plan for the planned locations. Information on signage size and materials is outlined in the appendix.

11.3: Preconstruction Meeting

Prior to construction the developer, contractor and traffic control company will attend a pre-construction meeting with HRM staff to review the CMP document on site. HRM's engineering technician will confirm the date and time of this meeting; and may wish to waive the requirement.

11.4: Construction Notification

Approximately five (5) business days prior to the encroachment, an additional notification will be circulated to the neighbouring properties, notifying them that work is starting on site.

Section 12: Summary

This construction management plan was prepared with the goal to minimize negative impacts to the community, pedestrians, and traffic throughout the scope of this project. This plan will be used as a minimum standard and any further safety protection required or methods to provide a more positive environment will be used throughout construction work as necessary.

Should you have any questions or comments related to this document, please contact SDMM. For all construction-related inquiries, please contact the developer, contractor, or traffic control service provider.

Regards,

Servant, Dunbrack, McKenzie & MacDonald Ltd.

Geoff MacLean, P.Eng.

Project Engineer

Z:\SDMM\37000-37999\37350\37369\CMP\Rev3\397 Windmill Road - CMP (Rev3) - 37369..docx

APPENDIX

Appendix A – Encroachment Plan

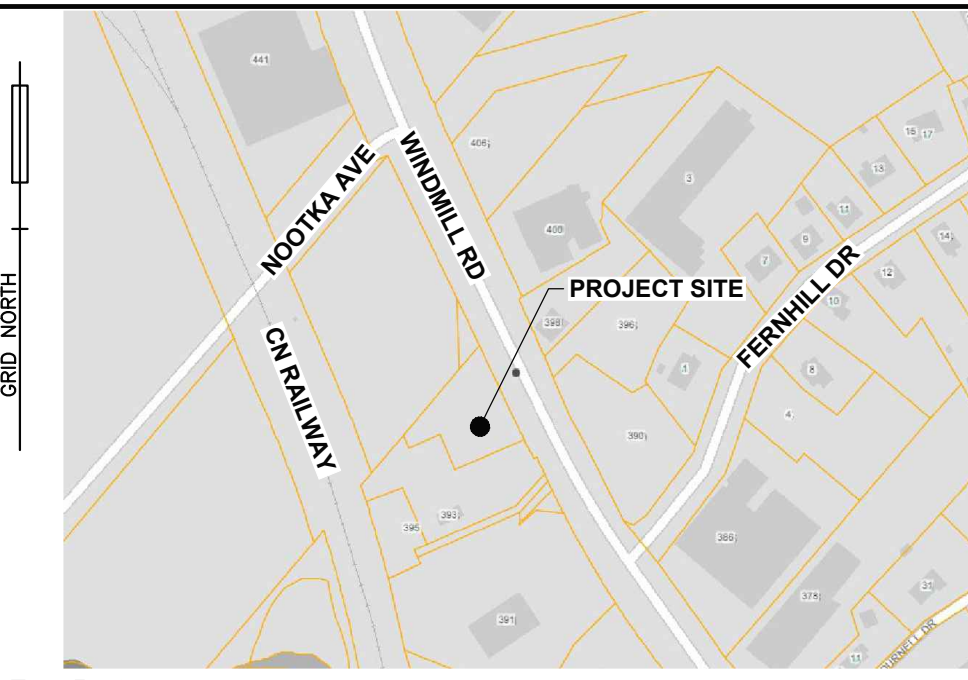

KEY PLAN

LEGEND

EXISTING	PROPOSED	
25.0	CONTOUR LINE	25.0
⊙/⊙BF	CURB STOP/GATE/BUTTERFLY VALVE	⊙/⊙BF
⊙	FIRE HYDRANT	⊙
⊏	CONCRETE THRUST BLOCK	⊏
⊏	SIAMESE CONNECTION	⊏
⊏	CATCH BASIN/PIT	⊏
⊏	CULVERT	⊏
⊏	ROCK LINING/DAM	⊏
⊏	ROCK WALL/RETAINING WALL	⊏
⊏	POWER POLE & ANCHOR/LIGHT STANDARD	⊏
⊏	TREE	⊏
⊏	STREET SIGN/PARKING METER	⊏
× 131.82	ELEVATION/GRADE	125.00 × / 125.00
⊏	TEST PIT	⊏
⊏	DRAINAGE/SWALE FLOW DIRECTION	⊏
W	WATER MAIN/SERVICE	W
SAN	SANITARY MANHOLE & PIPE	SAN
STM	STORM MANHOLE & PIPE	STM
SAV/STM	COMBINED PIPE	SAV/STM
GAS	GAS LINE	GAS
FL	100YR. FLOOD LIMIT	FL
⊏	GUARD RAIL	⊏
⊏	UNDERGROUND CONDUIT	⊏
⊏	OVERHEAD WIRES	⊏
⊏	PROPERTY LINE/BOUNDARY	⊏
⊏	FENCE	⊏
⊏	BUILDING	⊏
⊏	TOP OF SLOPE	⊏
⊏	TOE OF SLOPE	⊏
⊏	TREELINE	⊏
⊏	LIMITS OF DISTURBANCE	⊏
⊏	TACTILE PEDESTRIAN PLATES	⊏
⊏	PROJECT SAFETY SIGNAGE	⊏
⊏	ORANGE SANHORSE BARRICADE	⊏

NOTES

- THIS PLAN IS IN METRIC.
- EXISTING CONDITIONS WITH APPROXIMATE LOCATIONS ARE BASED ON GOOGLE AERIAL IMAGERY AS SITE HAS NOT BEEN FIELD SURVEYED; DIMENSIONS MAY VARY AND SHALL BE CONFIRMED BY CONTRACTOR BEFORE PROCEEDING WITH CONSTRUCTION.

No.	YY/MM/DD	Revision	Description	Appr'd
0	24/07/17	ISSUED FOR PERMIT		

G.K. MacLean
8978

SDMM
Servant, Dunbrack, McKenzie & MacDonald Ltd.
NOVA SCOTIA LAND SURVEYORS & CONSULTING ENGINEERS

36 QUAND CRESCENT
BIRDS LAKE BUSINESS PARK
HALIFAX, NS B3S 1C6

PHONE: (902) 455-1537
FAX: (902) 455-9479
WEB: www.sdmm.co

**WINDMILL APARTMENT BUILDING
397 WINDMILL ROAD
DARTMOUTH, NOVA SCOTIA**

**PHASE 1 – EXCAVATION
ENCROACHMENT PLAN**

Date	Drawn	Project No.
JULY 17, 2024	D. ANDERSON	FILE NO. 1-7-179A (37369)
Scale	Engineer	Plan No.
1:250	G. MACLEAN	
Reference	Approved	Drawing Name
--	G. MACLEAN	R1-A
Surveyed	Sheet	
SDMM		

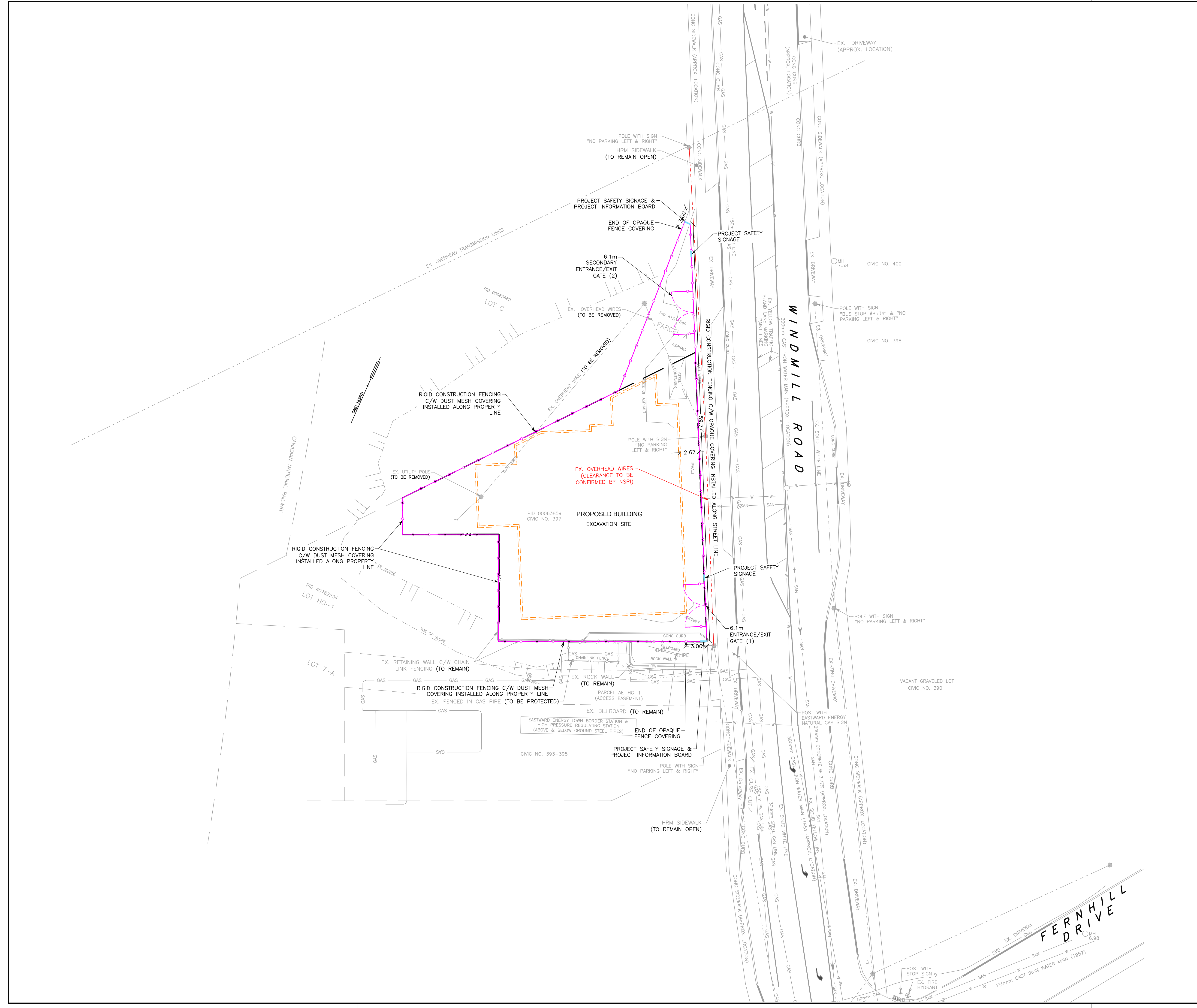
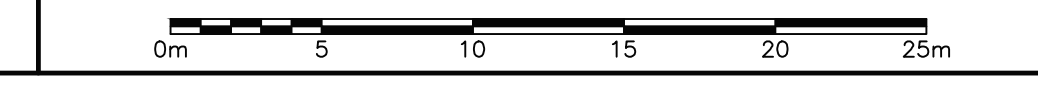

Appendix B – Traffic Control Plans TCP

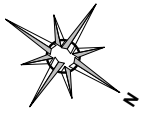

Encroachment Signage Plan Phase 1

Date: 2024-07-26 Author: Norman Bussmann, TWS, Frontline Traffic Services, 902-817-3364 Project: 397 Windmill Rd
 Contrator: SDMM Contact: Geoff MacLean, 902-789-6374
 Comments:
 Not to Scale
 Encroachment Signage Plan
 Off Shoulder Work Area,
 No Sidewalk Encroachment in this phase

Legend	
	Chain Link Fencing with Dust Control Hoarding
	Gate
	Sanitary Line
	Storm Line
	Water Line

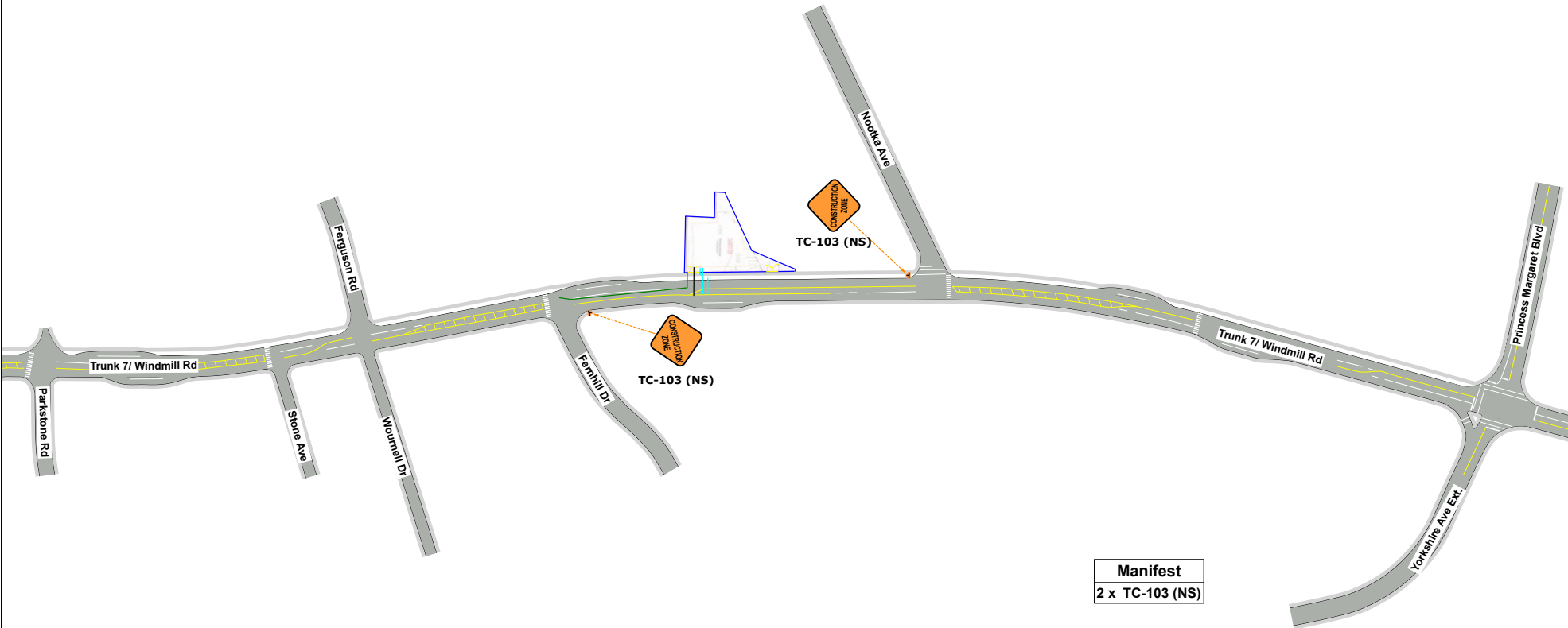

Manifest
 2 x TC-103 (NS)

Barrier Installation Plan Phase 2

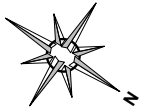

Date: 2024-07-26 Author: Norman Bussmann, TWS, Frontline Traffic Services, 902-817-3364 Project: 397 Windmill Rd
 Contrator: SDMM Contact: Geoff MacLean, 902-789-6374
 Comments:
 Not to Scale
 Barrier installation Plan Phase 2
 Application Guide B35
 See Pedestrian Management Plan for sidewalk closure details

Legend

- Chain Link Fencing with Dust Control Hoarding
- Cone
- Gate
- Rigid Fencing with Opaque Hoarding
- Work Area

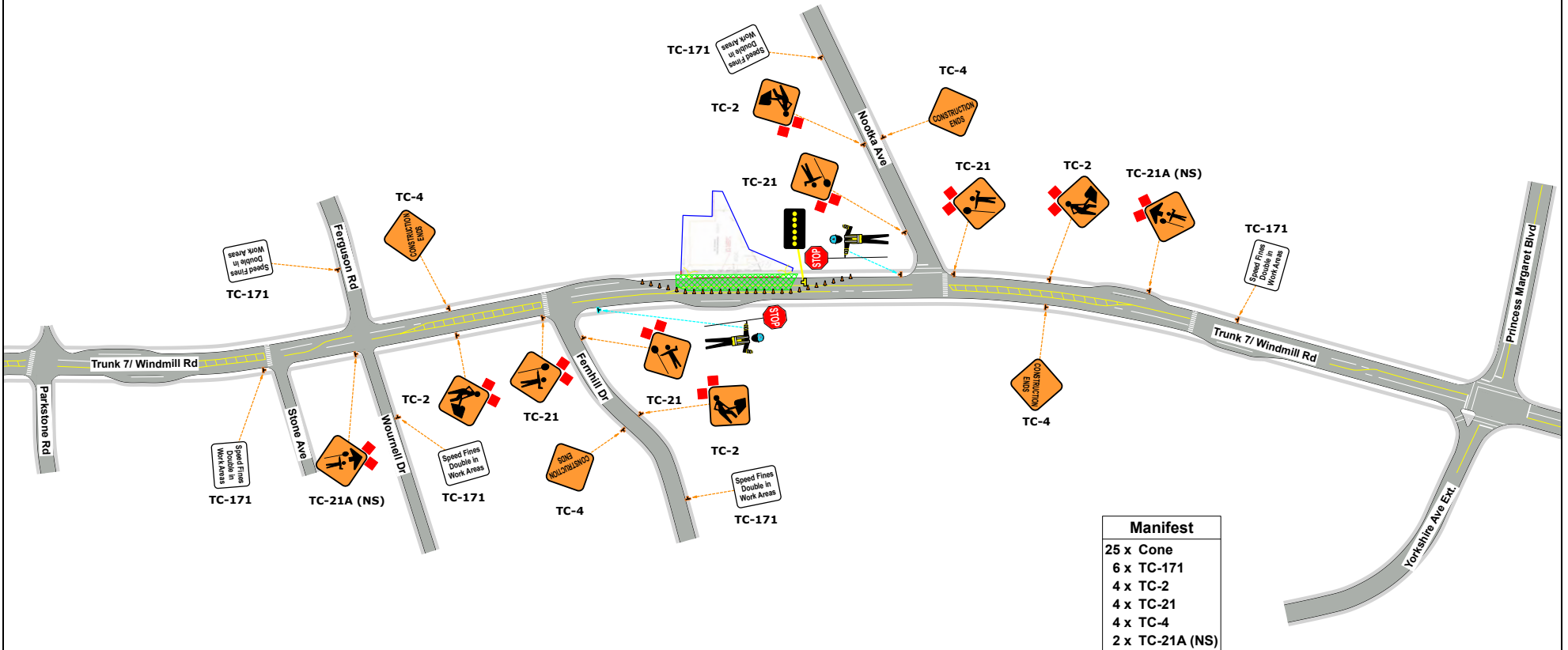

Manifest

25 x Cone
6 x TC-171
4 x TC-2
4 x TC-21
4 x TC-4
2 x TC-21A (NS)

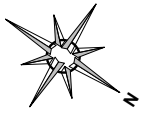

Encroachment Signage Plan Phase 2

Date: 2024-07-26 Author: Norman Bussmann, TWS, Frontline Traffic Services, 902-817-3364 Project: 397 Windmill Rd
 Contrator: SDMM Contact: Geoff MacLean, 902-789-6374
 Comments:
 Not to Scale
 Encroachment Signage Plan Phase 2
 Application Guide C12
 Off Shoulder Work Area,
 See Pedestrian Management Plan for sidewalk closure details

Legend

- Chain Link Fencing with Dust Control Hoarding
- Gate
- Sanitary Line
- Storm Line
- Water Line

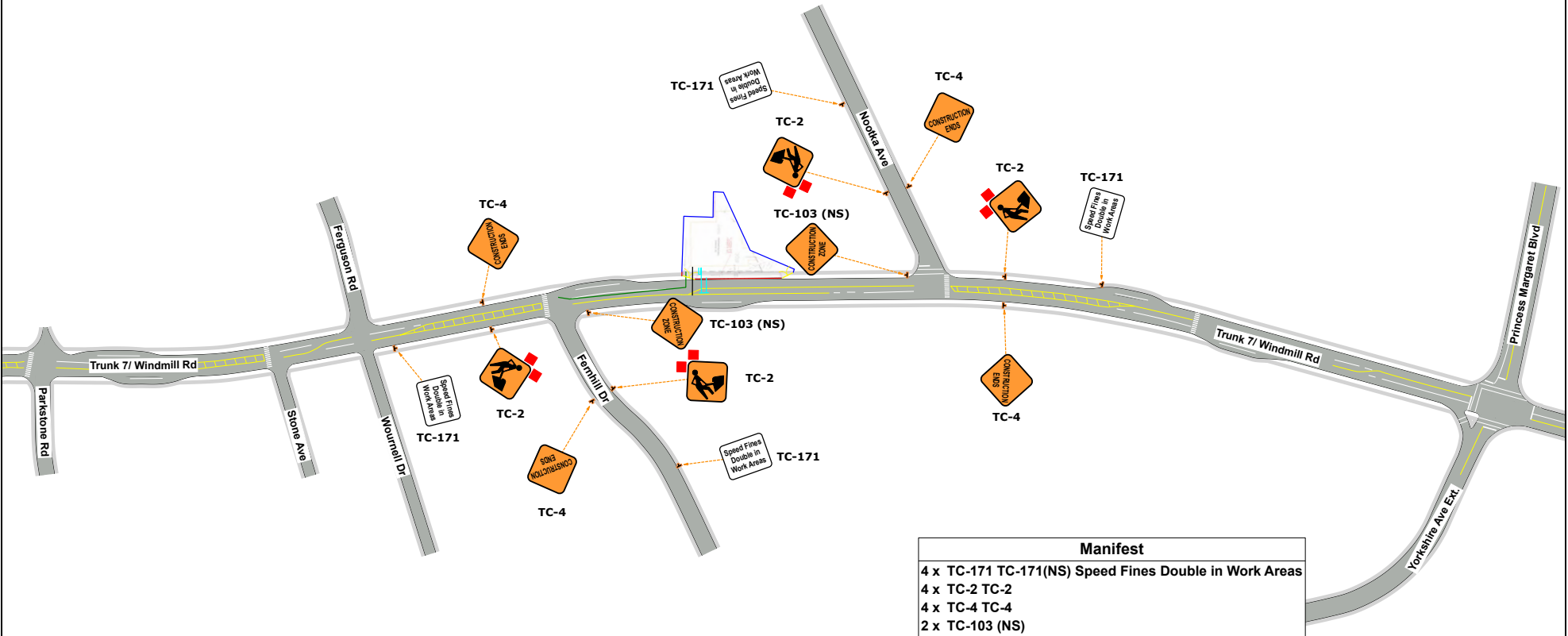

Manifest

4 x TC-171	TC-171(NS)	Speed Fines Double in Work Areas
4 x TC-2	TC-2	
4 x TC-4	TC-4	
2 x TC-103 (NS)		

397 Windmill Rd Line Painting Plan

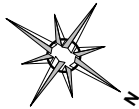

Date: 2024-07-26 Author: Norman Bussmann, TWS, Frontline Traffic Services, 902-817-3364 Project: 397 Windmill Rd
 Contrator: SDMM Contact: Geoff MacLean, 902-789-6374
 Comments:
 Not to Scale
 Application Guide C112/B35
 Line Painting Plan
 For the removal, installation and re-installment of painted lines adjacent to the encroachment
 No Sidewalk impact
 Line Painting must be completed prior to encroachment Phase 3 installation.

Legend

- Cone
- Work Area

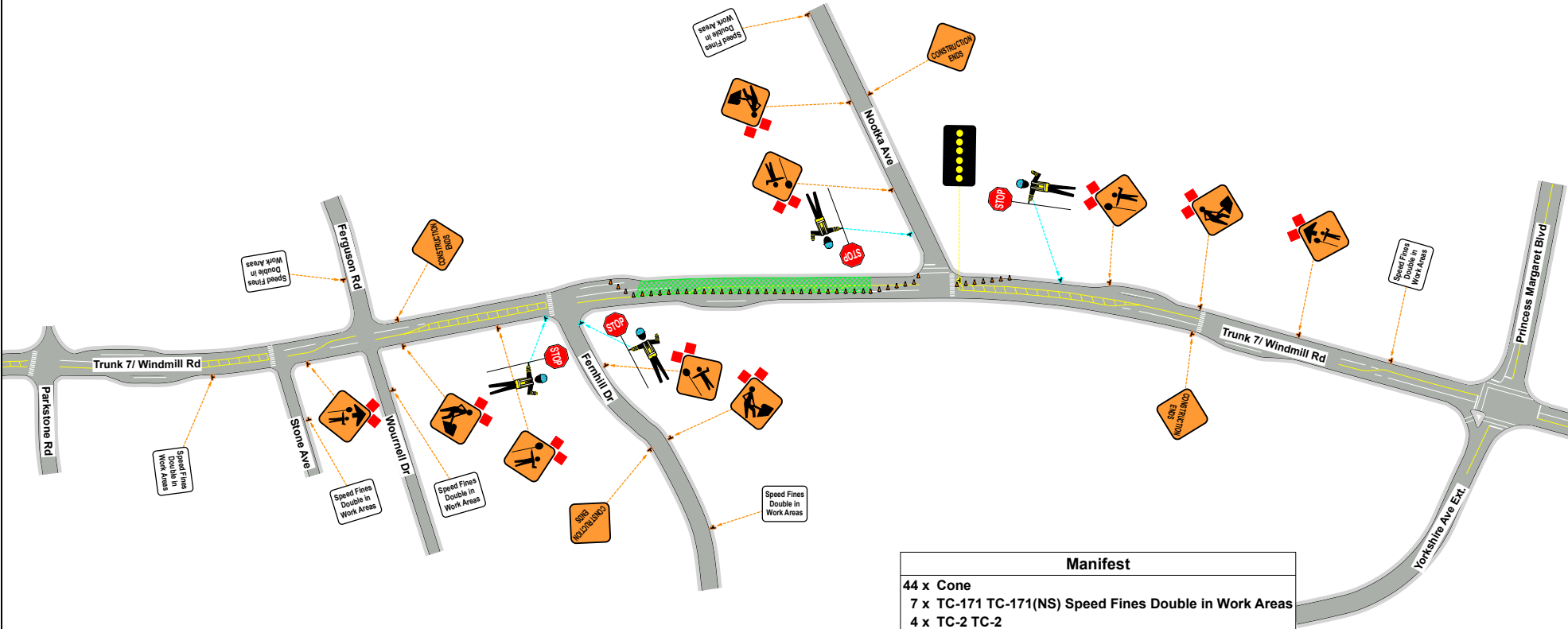

Manifest	
44 x	Cone
7 x	TC-171 TC-171(NS) Speed Fines Double in Work Areas
4 x	TC-2 TC-2
4 x	TC-21 TC-21
4 x	TC-4 TC-4
2 x	TC-21A (NS) TC-21A



Barrier Installation and Removal Plan Phase 3

Date: 2024-07-26 Author: Norman Bussmann, TWS, Frontline Traffic Services, 902-817-3364 Project: 397 Windmill Rd
 Contrator: SDMM Contact: Geoff MacLean, 902-789-6374
 Comments:
 Not to Scale
 Barrier Installation and Removal Plan Phase 3
 Application Guide B35
 See Pedestrian Management Plan for sidewalk closure details

Legend

- Barrel
- Chain Link Fencing without Hoarding
- Cone
- F-type Barrier
- Gate
- Sanitary Line
- Storm Line
- Water Line
- Work Area

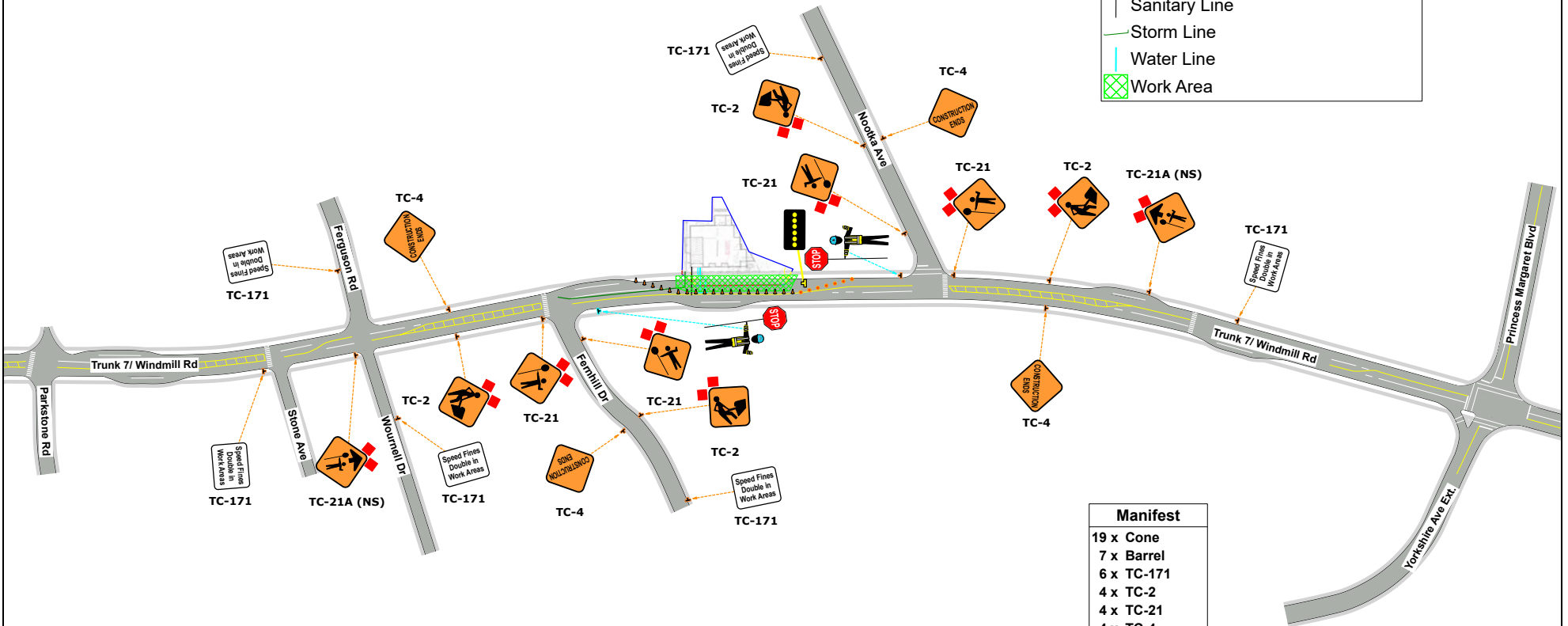

Manifest

19 x Cone
7 x Barrel
6 x TC-171
4 x TC-2
4 x TC-21
4 x TC-4
2 x TC-21A (NS)

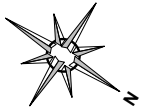

Encroachment Signage Plan Phase 3

Date: 2024-07-26 Author: Norman Bussmann, TWS, Frontline Traffic Services, 902-817-3364 Project: 397 Windmill Rd
 Contrator: SDMM Contact: Geoff MacLean, 902-789-6374
 Comments:
 Not to Scale
 Encroachment Signage Plan Phase 3
 Application Guides C12, B48 Blended
 See Pedestrian Management Plan for sidewalk closure details

Legend	
	Chain Link Fencing without Hoarding
	F-type Barrier
	Gate
	Sanitary Line
	Storm Line
	Water Line

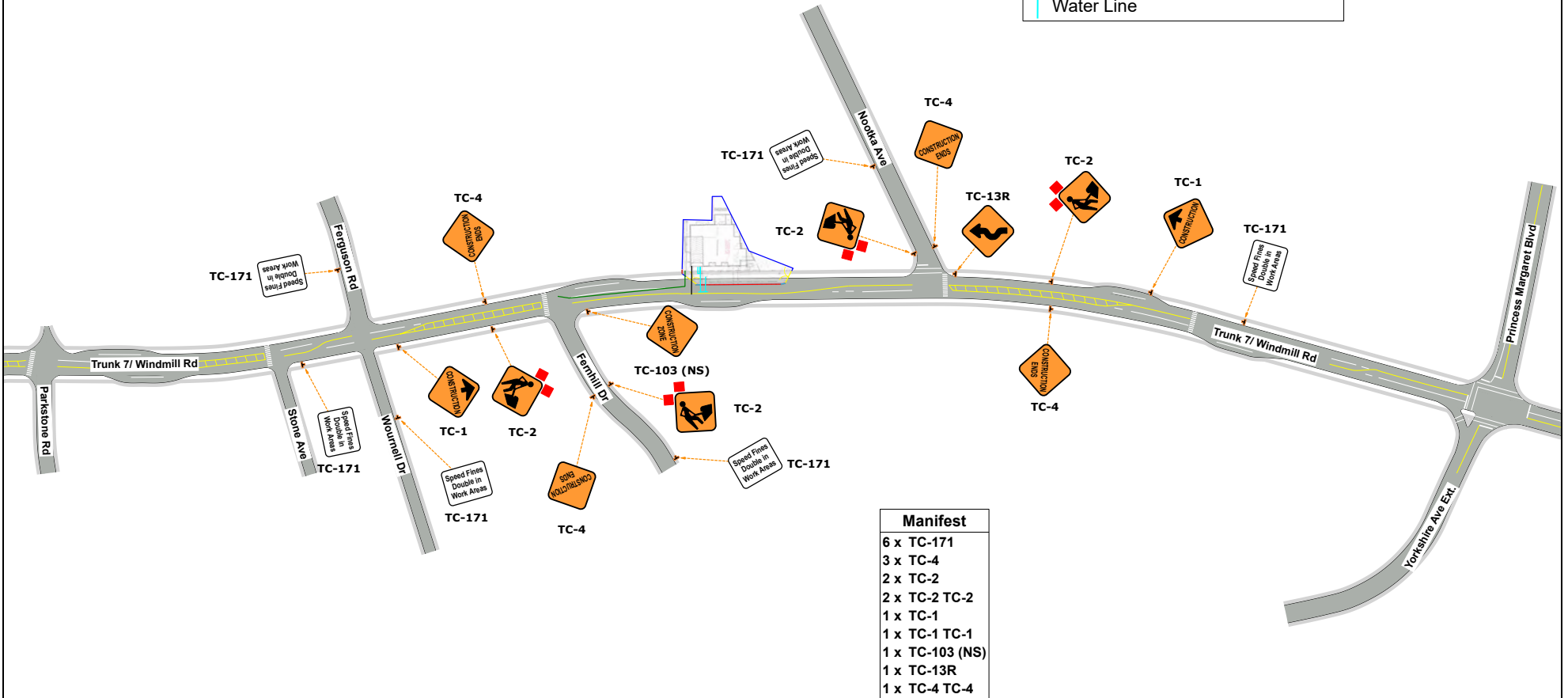

Manifest
6 x TC-171
3 x TC-4
2 x TC-2
2 x TC-2 TC-2
1 x TC-1
1 x TC-1 TC-1
1 x TC-103 (NS)
1 x TC-13R
1 x TC-4 TC-4

Pavement, Curb and Sidewalk Reinstatement

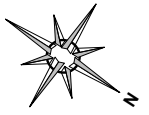

Date: 2024-07-26 Author: Norman Bussmann, TWS, Frontline Traffic Services, 902-817-3364 Project: 397 Windmill Rd
 Contrator: SDMM Contact: Geoff MacLean, 902-789-6374
 Comments:
 Not to Scale
 Application Guide B35
 Pavement, Curb and Sidewalk reinstatement Plan
 See Pedestrian Management Plan for sidewalk closure details

Legend	
	Barrel
	Chain Link Fencing without Hoarding
	Cone
	F-type Barrier
	Gate
	Work Area

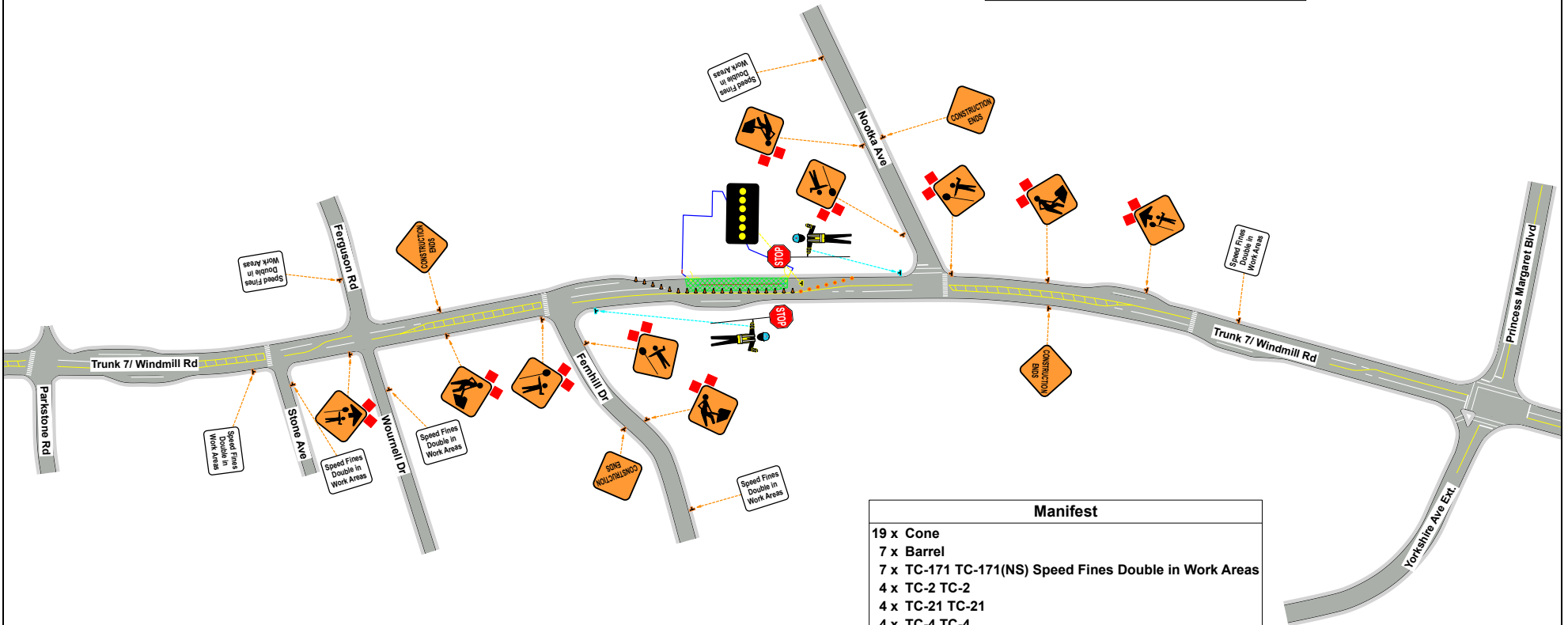

Manifest	
19 x	Cone
7 x	Barrel
7 x	TC-171 TC-171(NS) Speed Fines Double in Work Areas
4 x	TC-2 TC-2
4 x	TC-21 TC-21
4 x	TC-4 TC-4
2 x	TC-21A (NS) TC-21A

Service Laterals Installation and Decommissioning Plan



Date: 2024-07-26 Author: Norman Bussmann, TWS, Frontline Traffic Services, 902-817-3364 Project: 397 Windmill Rd
 Contrator: SDMM Contact: Geoff MacLean, 902-789-6374
 Comments:
 Not to Scale
 Application Guide B35
 Service Laterals Installation and Decommissioning Plan
 See Pedestrian Management Plan for sidewalk closure details

Legend

- Barrel
- Chain Link Fencing without Hoarding
- F-type Barrier
- Gate
- Sanitary Line
- Water Line
- Work Area

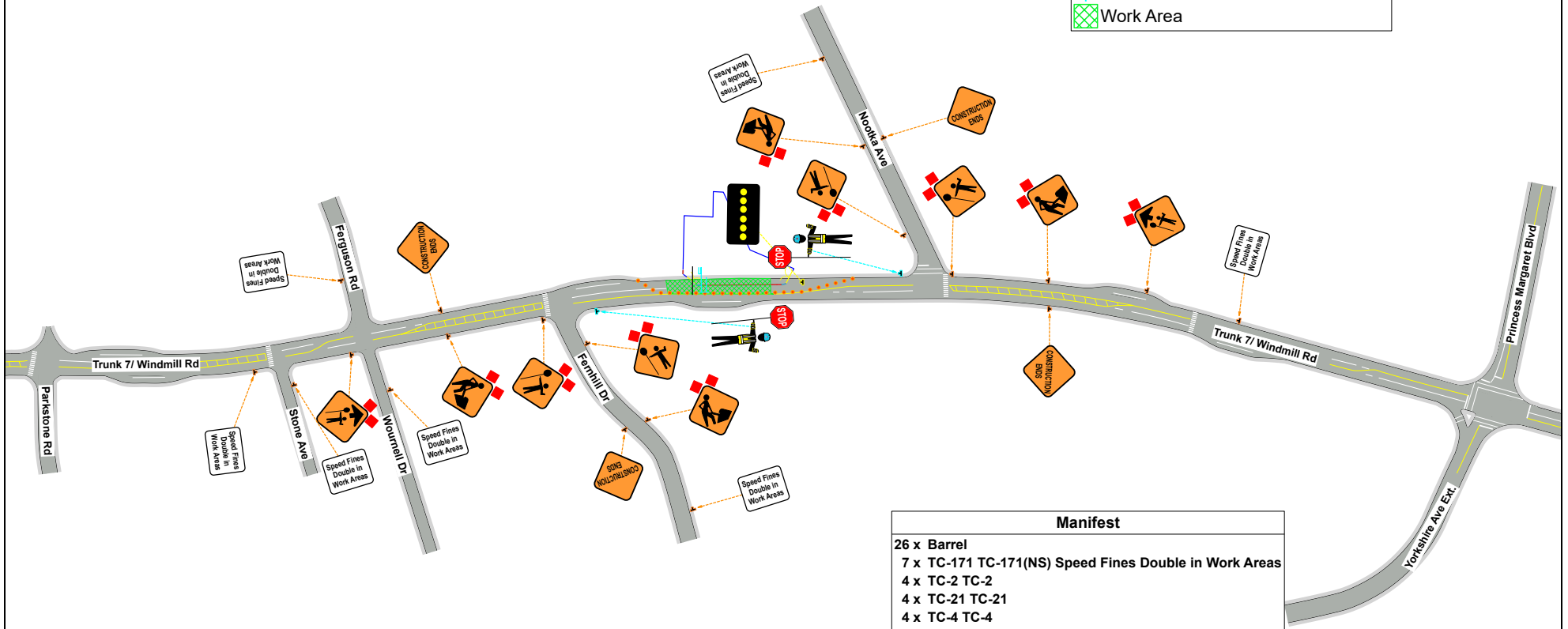

Manifest

- 26 x Barrel
- 7 x TC-171 TC-171(NS) Speed Fines Double in Work Areas
- 4 x TC-2 TC-2
- 4 x TC-21 TC-21
- 4 x TC-4 TC-4
- 2 x TC-21A (NS) TC-21A

Storm Line Installation Plan

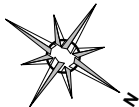

Date: 2024-07-26 Author: Norman Bussmann, TWS, Frontline Traffic Services, 902-817-3364 Project: 397 Windmill Rd
 Contrator: SDMM Contact: Geoff MacLean, 902-789-6374
 Comments:
 Not to Scale
 Application Guides B35 and C112
 Storm Line installation Plan
 See Pedestrian Management Plan for sidewalk closure details

Legend	
	Barrel
	Chain Link Fencing without Hoarding
	F-type Barrier
	Gate
	Work Area

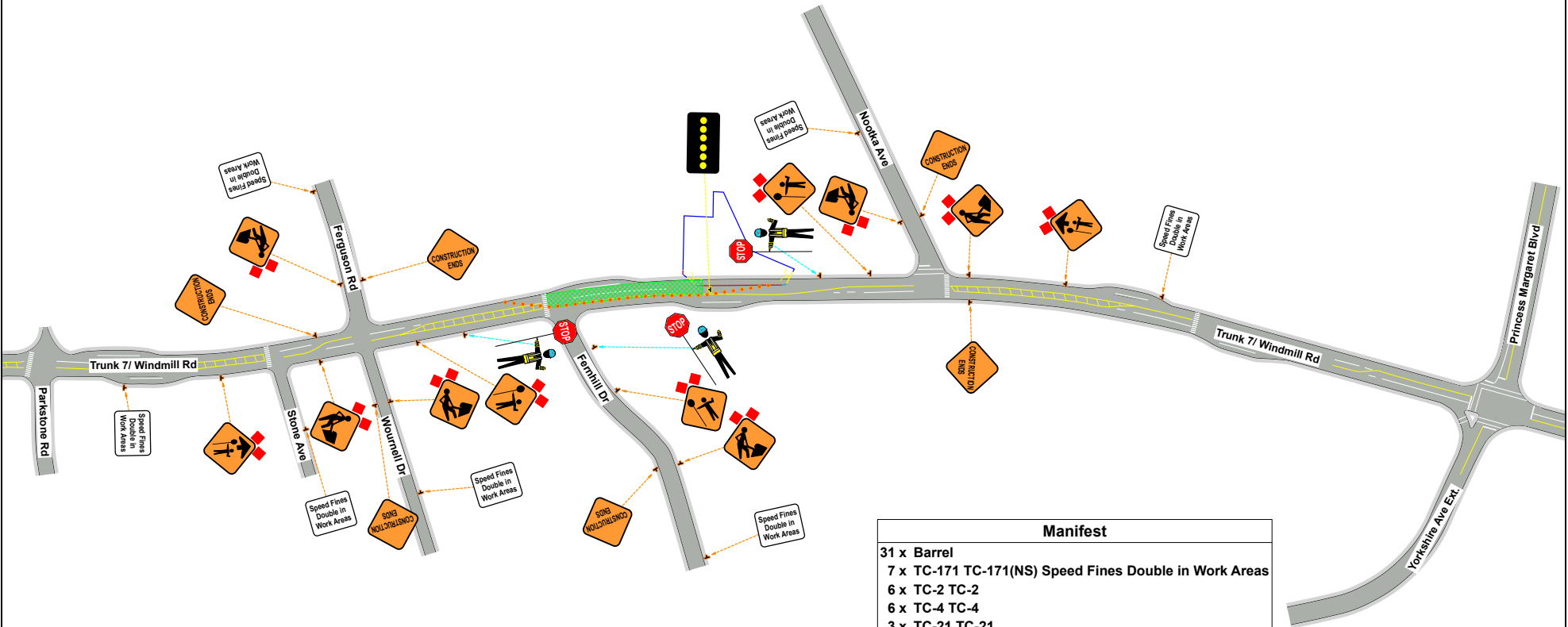

Manifest	
31 x	Barrel
7 x	TC-171 TC-171(NS) Speed Fines Double in Work Areas
6 x	TC-2 TC-2
6 x	TC-4 TC-4
3 x	TC-21 TC-21
2 x	TC-21A (NS) TC-21A

Appendix C – Haul Route Plan

Haul Route Plan Phase 1

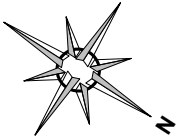

Date: 2023-02-28 Author: Norman Bussmann, TWS, Frontline Traffic Services, 902-817-3364 Project: 397 Windmill Rd
Contrator: SDMM Contact: Geoff MacLean, 902-789-6374
Comments:
Not to Scale
Haul Route Plan
In and Outbound via Windmill Rd

Legend	
	Chain Link Fencing with Dust Control Hoarding
	Gate
	Haul Route Inbound
	Haul Route Outbound

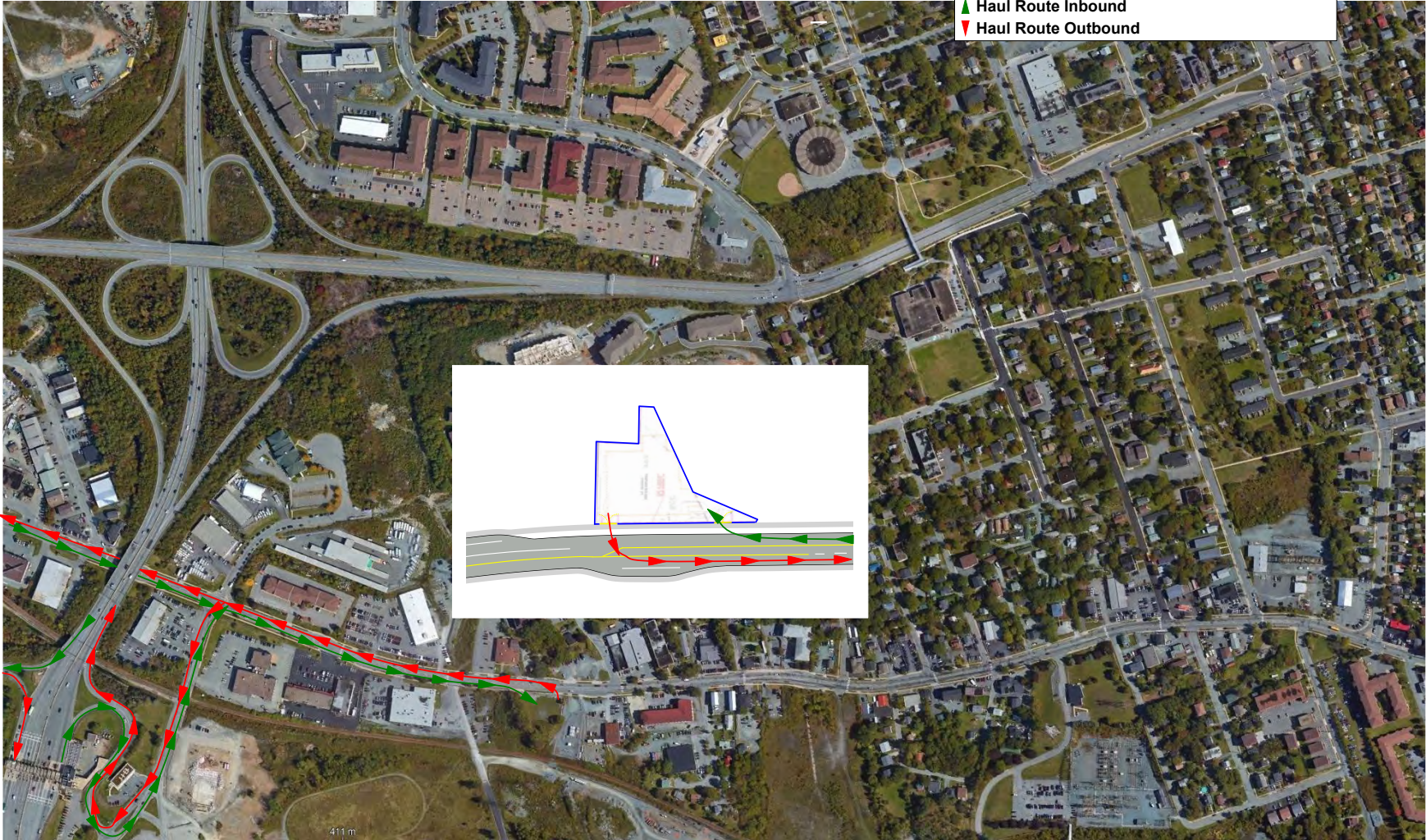

411 m

Haul Route Plan Phase 2

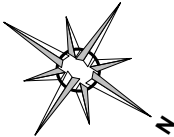

Date: 2023-02-28 Author: Norman Bussmann, TWS, Frontline Traffic Services, 902-817-3364 Project: 397 Windmill Rd
Contrator: SDMM Contact: Geoff MacLean, 902-789-6374
Comments:
Not to Scale
Haul Route Plan Phase 2
In and Outbound via Windmill Rd

Legend	
	Chain Link Fencing with Dust Control Hoarding
	Gate
	Haul Route Inbound
	Haul Route Outbound
	Sanitary Line
	Storm Line
	Water Line

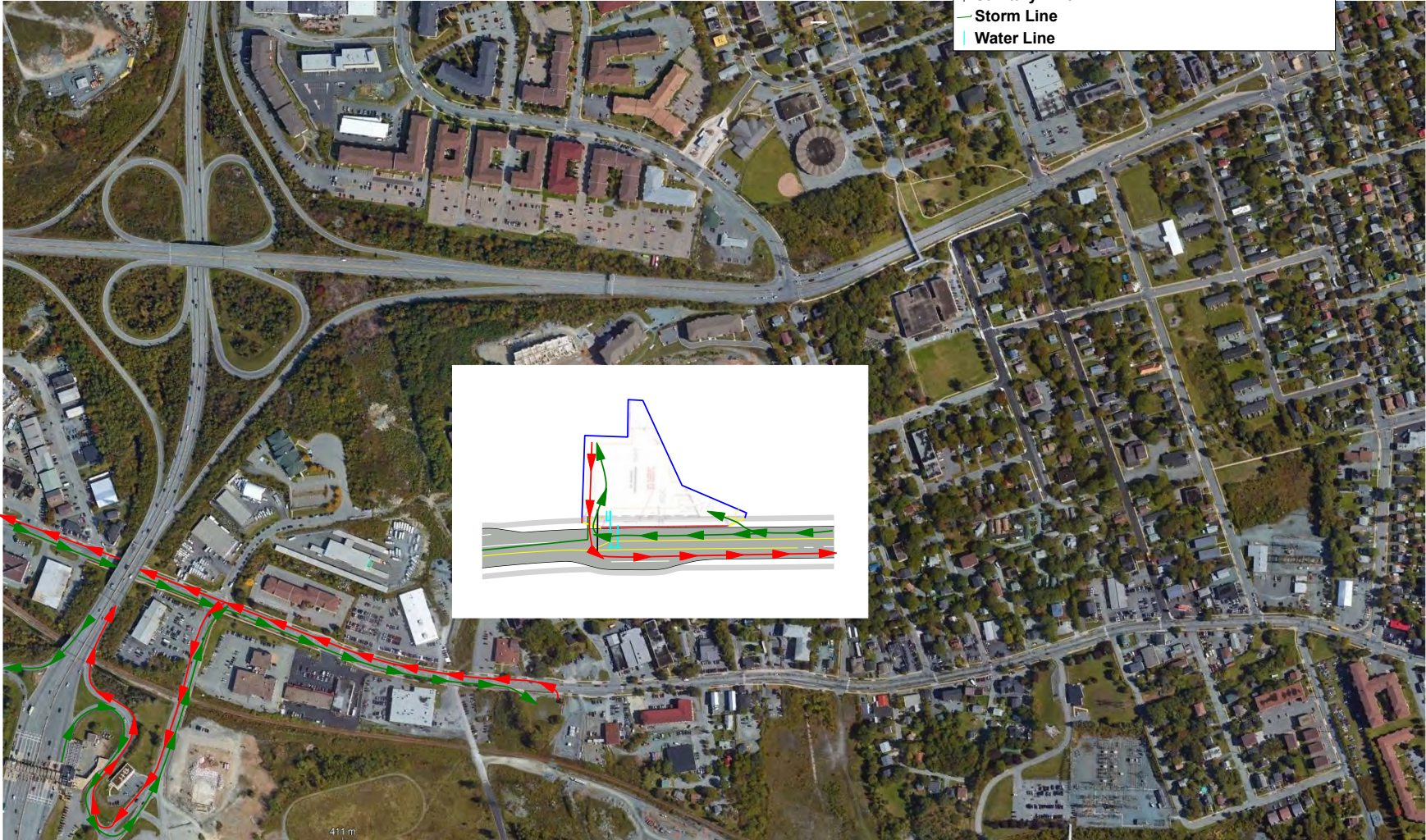

Haul Route Plan Phase 3

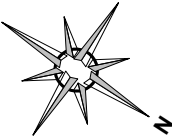

Date: 2023-02-28 Author: Norman Bussmann, TWS, Frontline Traffic Services, 902-817-3364 Project: 397 Windmill Rd
Contrator: SDMM Contact: Geoff MacLean, 902-789-6374
Comments:
Not to Scale
Haul Route Plan Phase 3
In and Outbound via Windmill Rd



Appendix D – Pedestrian Management Plan (PMP)

Pedestrian Management Plan

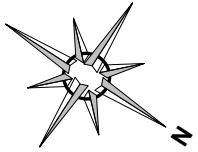

Date: 2024-07-26 Author: Norman Bussmann, TWS, Frontline Traffic Services, 902-817-3364 Project: 397 Windmill Rd
Contrator: SDMM Contact: Geoff MacLean, 902-789-6374

Comments:
Not to Scale
Pedestrian Management Plan
For Long Duration closure of sidewalk on West side of Windmill Rd

Manifest
2 x TC-145 with TC-64A
2 x TC-145AL
1 x TC-145AR

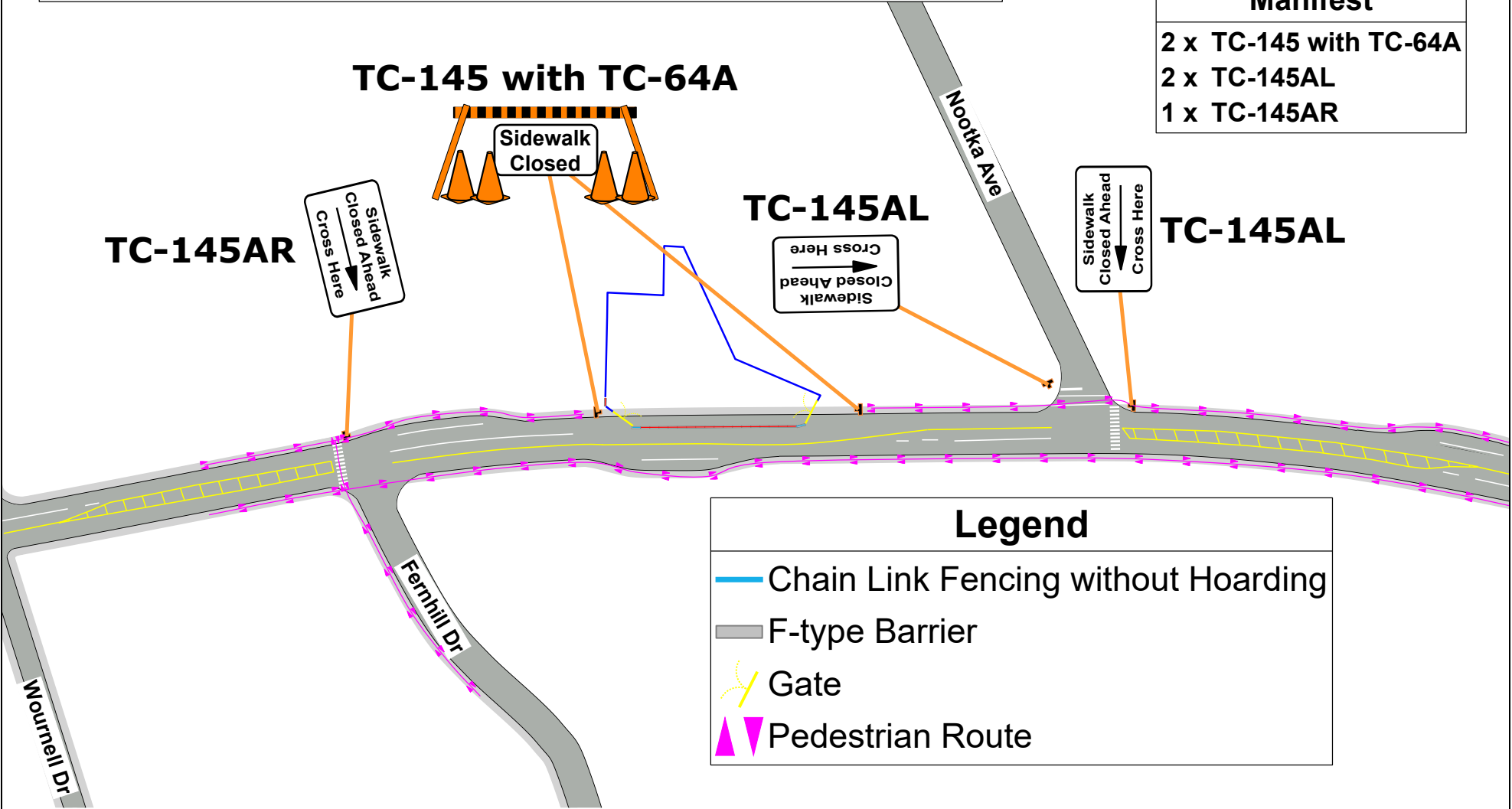

TC-145AR

TC-145 with TC-64A

TC-145AL

TC-145AL

Legend

- Chain Link Fencing without Hoarding
- F-type Barrier
- Gate
- ▲▼ Pedestrian Route

Appendix E – Barrier, Fence & Gates Information

Sample Barrier & Fence Details

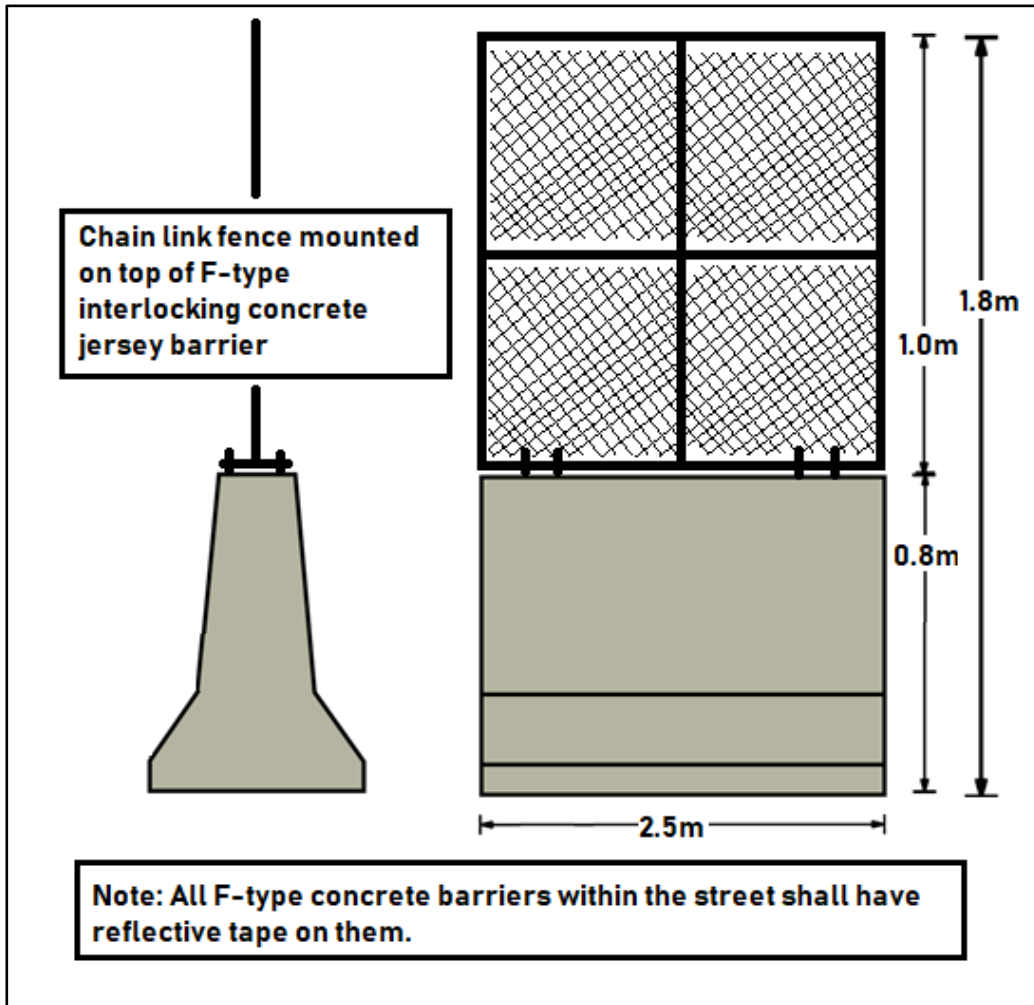
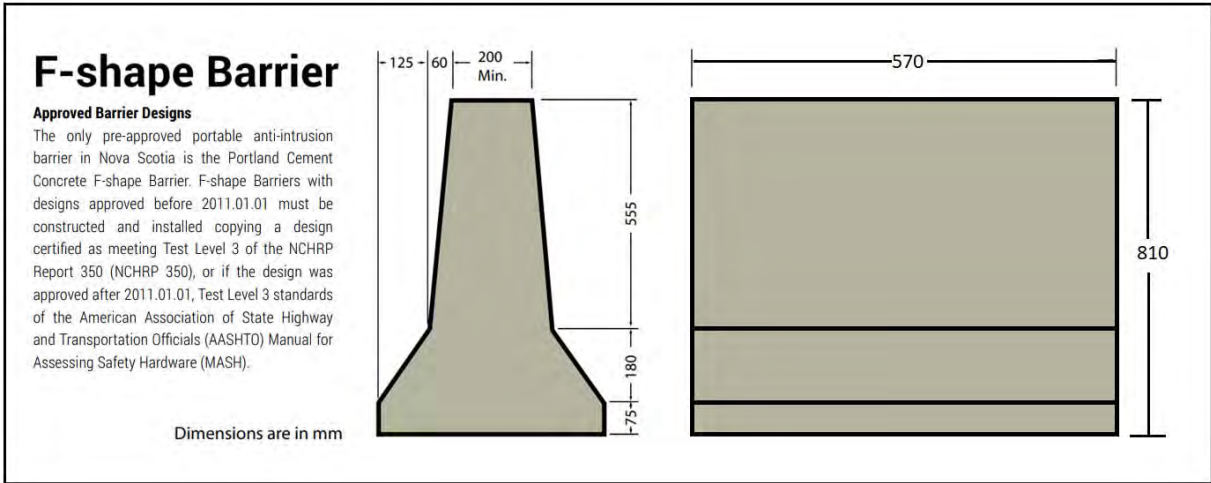

Chain link fence

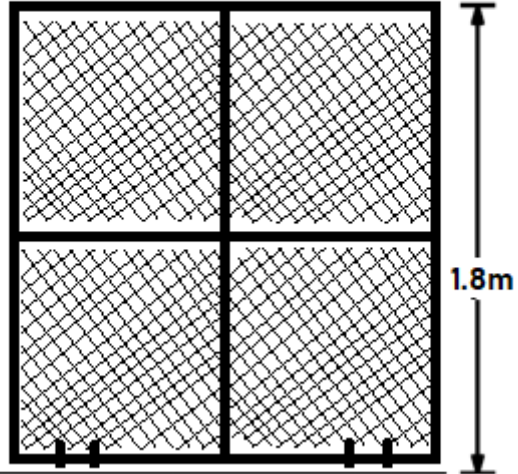

Modual Fencing

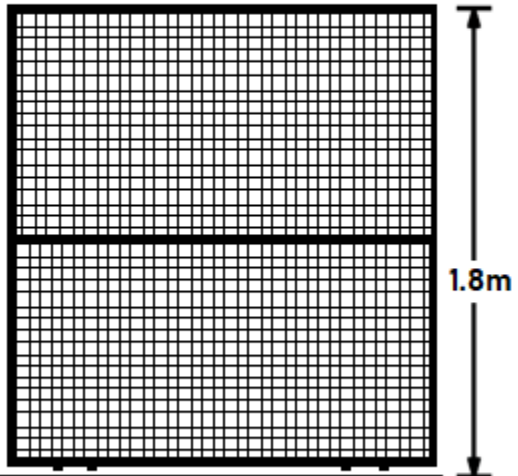

Sample Gate Detail

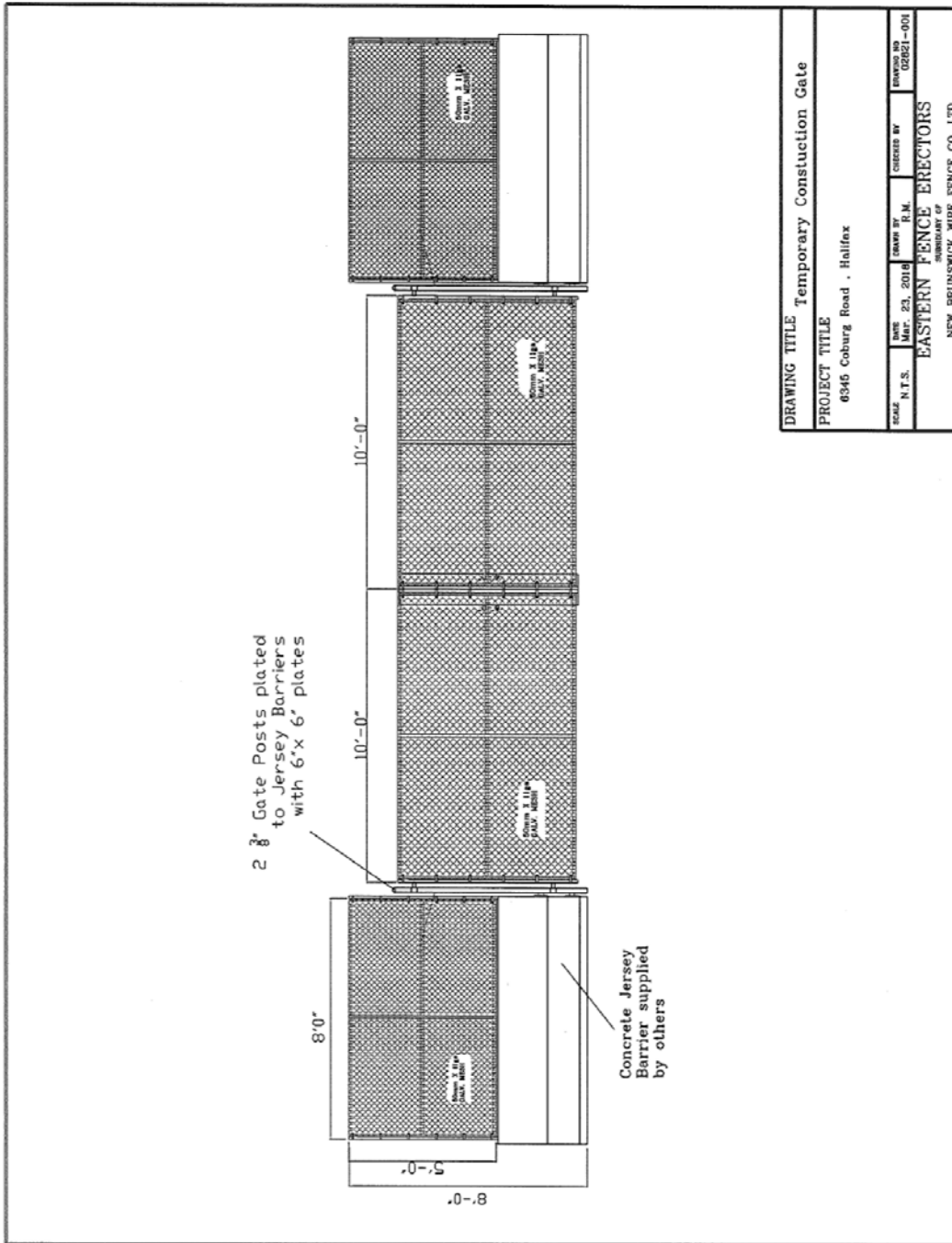

DRAWING TITLE Temporary Constuction Gate			
PROJECT TITLE 6346 Coburg Road . Halifax			
SCALE N.T.S.	DATE Mar. 23, 2018	DRAWN BY R.M.	CHECKED BY R.M.
EASTERN FENCE ERECTORS NEW BRUNSWICK WIRE FENCE CO. LTD			

Appendix F – Hoarding Information

Opaque construction hoarding material shall covering and be adequately secured to the rigid fencing that outlines the encroachment area. This covering shall be continuous such that it prevents passersby or tourist from seeing through the fencing and gates to the active construction site.

UltraMesh® Eclipse® if a 7.96 oz. which is a polyester, black-backed mesh that is used where complete opacity is required.

UltraMesh Eclipse is UV printable for project renderings and is typically used for building and fence graphic wraps. The product is available in widths of 126" and 196".

Product example is shown below with the technical data sheet on the following page.

Tarp Option



Print Banner Option



UltraMesh Eclipse is a 7.96 oz. polyester, black-backed mesh. The material is ideal for applications where complete opacity is required. UltraMesh Eclipse is UV printable and may be used for building wraps and fence graphics. Available in widths of 126 and 196 .

Material Details

CHARACTERISTICS	TEST METHOD	METRIC	ENGLISH
Base Fabric	100% PES	1000D×1000D	
Construction			12×12
Total Weight	DIN53352 BS3424 Method5A	270 +/- 20 gsm/m ²	7.96 oz/yd ²
Width		Up to 500cm	
Tensile Strength	DIN53352 BS3424	Warp 1250 n/5cm Weft 1100 n/5cm	142.75 x 130.19 lb/in
Tear Strength	DIN53356 BS3424	Warp 235 N Weft 225 N	52.8 x 50.5 lbf
Air Permeability	GB/T 2410-2008		2649 mm/s
Light Transmission	GB/T 5453-1997		37%
Temperature Resistance	DIN53357 BS3425 Method 10		-20°C :70°C

Applications

	Back-lit	Banner	Billboard	Block-out	Building Wrap	Fence Graphics	Truckside
Applications		■		■	■	■	

Ink Printability

Solvent	Eco Solvent	UV	Latex	Screen Printing	Dye Transfer	Dye Direct
		■				

Available Sizes

Metric (m)	English (inches)
3.20, 5.00	126 , 196

The information on physical and chemical characteristics is based upon tests believed to be reliable. The values are intended only as a source of information. A legally binding guarantee of specific properties is not to be inferred from our specifications. They are given without guaranty and do not constitute a warranty. A weight variance of +1/-2 is acceptable. The purchaser should independently determine, prior to use, the suitability of this material for his/her specific purpose. (Data represents averages and is not intended for use as a specification.)

ULTRAFLEX

Ultraflex Systems Inc.
Headquarters
203 Kelsey Lane, Suite E
Tampa, FL 33619
P: (973)627-6608
Email: sales@ultraflex.com

www.ultraflex.com
updated: 12/2016

Ultraflex Systems Inc.
1578 Sussex Turnpike, Bldg. 4
Randolph, NJ 07095
P: (973)627-8806
F: (973)627-8806
Email: sales@ultraflex.com

Ultraflex Europe
Unit 1 Handwick Road Industrial Park
Great Gravelton Bedfordshire
England SG19 3BJ
Phone: (44)1767-677-100
Email: sales.mg@ultraflex.com

Ultraflex Mexico
Avenida No. 112, Col. Granjas México
Del. Iztacalco, C.P. 06400, México D.F.
Tel: (52)51623632-3162-3698
01 800 822 32 31
Email: sales.mg@ultraflex.com

Ultraflex Guadalajara
Av. Patro No. 2804
Loma Bonita Sur,
Zapopan, Jalisco CP45060
Mexico
Tel: (52)3312-049-857

Appendix G – Project Information Board



August 2024 – June 2026

**WINDMILL APARTMENTS
397 Windmill Road**

10 Storey Building

60 Residential Units on 9 levels

Mixture of 1 bedroom & 2 Bedroom
Apartment Units

1 Level - Underground Parking

Surface and Underground Bicycle
Parking/Storage

Level 10 Landscape Rooftop with Indoor &
Outdoor Common Areas

Developer:

3309758 Nova Scotia Limited
2 Samuel Terrace, Halifax, NS, B3N 3A2

Construction Manager:

Antler Construction
57 Polara Drive,
Lower Sackville, NS, B4C 2B7

**24 Hour Emergency Contact:
Adam Wicks – (902) 388-6032**

Site Contractor:

Atlantic Road Construction and Paving
6 Belmont Avenue, P.O. Box 89
Eastern Passage, NS, B3G 1M7

**Contact:
Greg MacDonald - (902) 830-6411**

Traffic Control:

Frontline Traffic Services
6 Belmont Avenue, P.O. Box 89,
Eastern Passage, NS, B3G 1M7

**Contact:
Phil Pruneau - (902) 818-5548**

Rodent Control Company:

Rentokil Pest Control
51 Duke Street, Bedford, Bedford, NS

**Contact:
Main Office - (902) 835-2304**

Appendix H – Project Safety Signage



RESTRICTED
— AREA —

CONSTRUCTION
WORK IN
PROGRESS

Appendix I – Project Signage Specifications

Signage Specifications: Project Signage shall;

- Be constructed of weatherproof material (corrugated plastic)
- Have high visibility contrasting colours (dark letters on white background)
- Incorporate appropriate font types (mix of upper and lower-case lettering)
- Incorporate appropriate font sizes (16mm – 51mm) such that the signage is readable from a distance (16-20m)
- Size of signage will be poster size (600mm x 900mm) or larger; to allow community members to see and read the information from a distance
- Signage may incorporate plastic grommets positioned every 300mm around the perimeter of the signage to ensure a secure signage installation
- Signage will be installed/anchored to project fencing using plastic zip-ties
- Signage will be positioned along the project site as per the encroachment plan
- Signage shall not impede traffic of pedestrian sight lines
- **Signage shall be placed on site 10 days prior to the start of the noted construction activity to ensure the passing public has had adequate time to review, adjust their travel patterns, usage of streets and or can be considered 'informed'.**

Samples



Appendix J – Sample Traffic Notification Letter



**Proposed Multi-Unit Residential Building
397 Windmill Road**

DRAFT NOTIFICATION LETTER

TO WHOM IT MAY CONCERN

Date

NOTIFICATION OF TRAFFIC DISRUPTION: **Street Name, DARTMOUTH, NOVA SCOTIA**

This is to inform you that the to facilitate operations in association with the Multi-Unit Residential building construction work, traffic disruptions will occur on or about **DATE** with an anticipated duration of approximately **TIME**. The street will be **reduced(?)** to one lane of vehicular traffic during this time.

Should you have any questions or concerns please feel free to contact the below:

CONTACT INFORMATION

General Contractor:

Atlantic Road Construction and Paving

6 Belmont Avenue, P.O. Box 89

Eastern Passage, NS

B3G 1M7

Phone: (902) 830-6411

Should any questions arise, please feel free to contact the undersigned.

Yours Truly,

Greg MacDonald

Atlantic Road Construction and Paving

Appendix K – Vehicular and Pedestrian Hazard Assessment

Project

Date:

Location:

VEHICULAR & PEDESTRIAN HAZARD ASSESSMENT

No.	Hazard:	Project Phase:	Vehicular Impacts:	Mitigation Methods:	Pedestrian Impacts:	Mitigation Methods:
1	Excavation	Excavation	Vehicles may enter project site and fall down excavation.	Place concrete barriers along travel ways. Concrete barriers and existing curbs to prevent vehicle entry.	Pedestrians may enter project site and fall down excavation.	Place concrete barriers/rigid fencing around entire project site.
			Vehicle weight may surcharge excavation, causing excavation wall failure.	Close sidewalks & driveways adjacent to project site, moving vehicles farther away from excavation.		
2	Rock Blasting	Excavation	Blasted rock projectiles may strike vehicles.	Close sidewalks & driveways adjacent to site, moving vehicles farther away from blasted rock.	Blasted rock projectiles may strike pedestrians.	Install solid plywood hoarding along rigid fence adjacent to blasting zone.
3	Construction Waste	All Phases	Vehicles may be struck by construction waste.	The contractor shall keep the project site and surrounding areas clean and free of construction debris.	Pedestrians may be struck by construction waste.	The contractor shall keep the project site and surrounding areas clean and free of construction debris.
4	Vehicular & Pedestrian Activities	All Phases	Drivers and pedestrians may become confused or impatient with construction activities. Pedestrians may walk in unmarked crosswalks or in vehicular travel areas. Drivers may fail to obey traffic signage.	Vehicular and pedestrian signage will be posted prominently around the project site to facilitate pedestrian movement. Notification will be sent prior to all traffic interruptions.	Drivers and pedestrians may become confused or impatient with construction activities. Pedestrians may walk in unmarked crosswalks or in vehicular travel areas. Drivers may fail to obey traffic signage.	Vehicular and pedestrian signage will be posted prominently around the project site to facilitate pedestrian movement. Notification will be sent prior to all traffic interruptions.
5	Heavy Machinery Operation	All Phases	Heavy machinery or vehicles may break down or overturn, damaging other vehicles.	The contractor shall maintain safe distances between vehicles and heavy machinery on-site. Concrete barriers will be installed to separate construction vehicles from public traffic.	Heavy machinery or vehicles may break down or overturn, injuring pedestrians.	The contractor shall maintain safe distances between pedestrians, vehicles, and heavy machinery. Rigid fences will be installed to separate construction vehicles from pedestrians.
			Heavy machinery or vehicles may overturn due to uneven terrain, damaging other vehicles.	The contractor shall maintain safe distances between vehicles and heavy machinery on-site and ensure travel routes are kept flat.	Heavy machinery or vehicles may overturn due to uneven terrain, injuring pedestrians. Pedestrians may walk on uneven terrain causing them to twist their ankles or fall.	The contractor shall maintain safe distances between pedestrians, vehicles, and heavy machinery and ensure travel routes are kept flat.
6	Construction Signage	All Phases	Construction signage may strike vehicular traffic.	Construction signage will be securely fixed to existing poles, temporary concrete sign bases, or rigid fences.	Pedestrians may walk into construction signage, including traffic signage, wayfinding signs, etc. may.	Signage will be angled in line with pedestrian routes and/or be placed at heights such that they do not pose a risk to pedestrians.
					Construction signage may strike pedestrians.	Construction signage will be securely fixed to existing poles, temporary concrete sign bases, or rigid fences.
7	Dangerous Materials	All Phases	Flammable, explosive, & hot materials may damage vehicles if not properly maintained & stored.	The contractor will use and store dangerous materials properly as per manufacturers' specifications.	Flammable, explosive, & hot materials may injure pedestrians if not properly maintained & stored.	The contractor will use and store dangerous materials properly as per manufacturers' specifications.
8	Hoisting Operations	Superstructure	Precast concrete panels and other items hoisted may fall from heights and damage vehicles.	Proper hoisting and lifting techniques will be used to ensure that materials do not fall from heights. F-Type concrete barriers will be installed such that loads are never suspended above the public realm.	Precast concrete panels and other items hoisted may fall from heights and injure pedestrians.	Proper hoisting and lifting techniques will be used to ensure that materials do not fall from heights. Pedestrians will be moved to opposite sides of street from the project site or onto temporary sidewalks such that loads are never suspended above the public realm.
9	Reinstatement of Public Infrastructure & Service Installation	Superstructure	Heavy equipment and hot concrete used during public infrastructure reinstatement and service installation may cause damage to vehicles.	The contractor shall maintain safe distances between vehicles and heavy machinery on-site. Concrete barriers will be installed to separate construction vehicles from public traffic during public infrastructure reinstatement and service installation.	Heavy equipment and hot concrete used during public infrastructure reinstatement may injure pedestrians.	The contractor shall maintain safe distances between pedestrians, vehicles, and heavy machinery.
10	Fallen debris	Superstructure	Debris may fall from upper stories of the new building causing damage to vehicles.	F-Type concrete barriers will be installed such that a safe distance is maintained between the building envelope and vehicular traffic.	Debris may fall from upper stories of the new building injuring pedestrians.	Construction of upper building levels will be set back from the property line/rigid fencing, this separating pedestrians from potential fallen debris.

Appendix L – Community Consultation Records

COMMUNITY CONSULTATION MAP OVERVIEW

Project – Windmill Apartments

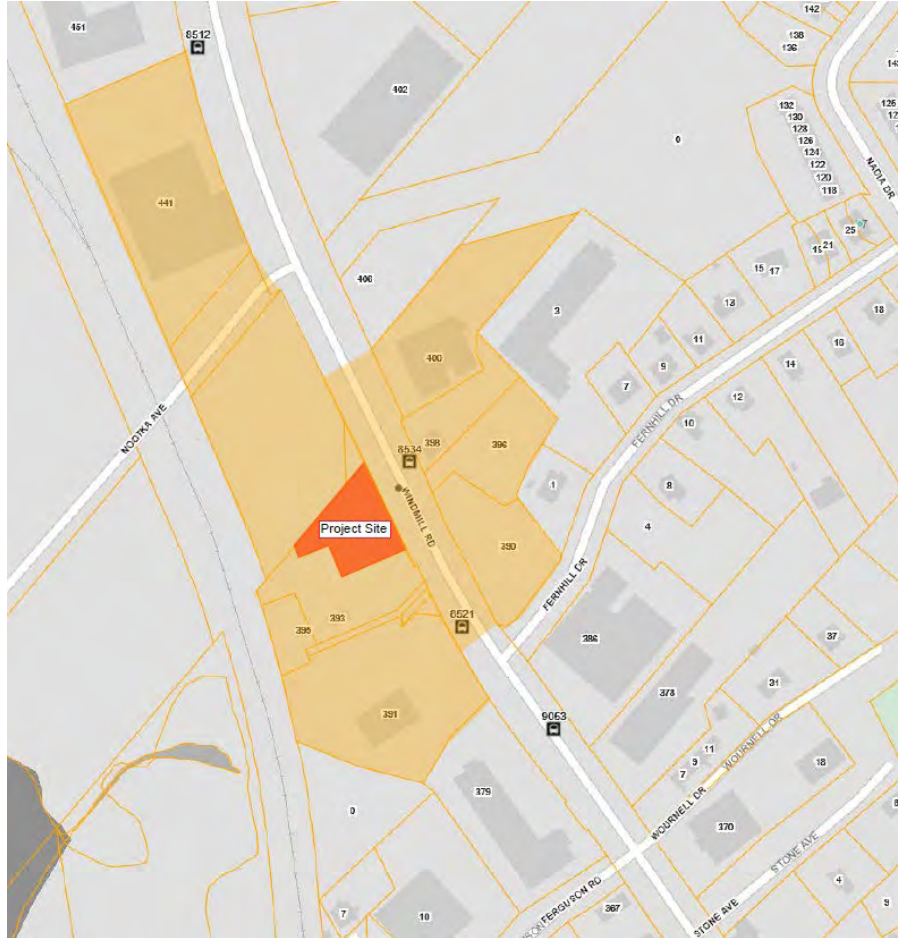

Notification Letter

Date: *****

3309758 Nova Scotia Limited – Building Construction Information Meeting

Dear Neighbour,

As you may be aware, we are planning an apartment building construction project located at 397 Windmill Road, Dartmouth.

If you are interested in receiving more information about our construction plans, practices, schedule and to go over any questions you may have regarding construction of our new project please contact us to discuss. We would be happy to meet with you to discuss.

Thank you.

Adam Wicks (Construction Manager)

Email: antlerconstruction@outlook.com

Cell: (902) 388-6032

Appendix M – HRM Tree Detail

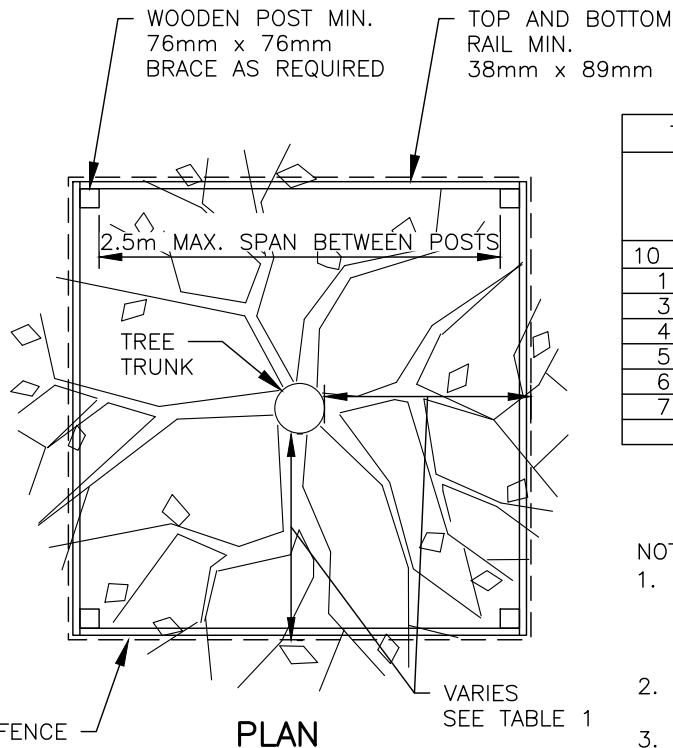

PLAN

TABLE 1

TREE PROTECTION ZONE CALCULATION TABLE

TRUNK DIAMETER (DBH)	MINIMUM PROTECTION DISTANCE REQUIRED (MEASURE FROM THE OUTSIDE EDGE OF TREE TRUNK)
10 CM & UNDER	1.2 METERS
11 – 30 CM	2.0 METERS
31 – 40 CM	3.4 METERS
41 – 50 CM	4.6 METERS
51 – 60 CM	6.0 METERS
61 – 70 CM	7.0 METERS
71 – 80 CM	8.0 METERS
>80 CM	9.0 METERS

NOTES:

1. WOOD POST: (MIN. 76mm WIDTH) INSTALLED TO A DEPTH OF 500mm. TOP AND BOTTOM RAIL: (MIN. 38 x 89mm CONSTRUCTION, MAX. SPAN 2.5m), CROSS BRACING AS REQUIRED.
2. NO GROUND DISTURBANCE WITHIN 1.2 METER OF THE TREE TRUNK (I.E. POST INSTALLATION)
3. POSTS SET BACK FROM SIDEWALK AND CURB: MIN 300mm
4. FENCE MATERIAL: MINIMUM ORANGE BARRIER FENCE OR METAL CHAIN LINK FENCE
5. ATTACH A SIGN ON TWO SIDES OF THE TREE "PROTECTION ZONE DO NOT REMOVE FENCE DURING CONSTRUCTION"

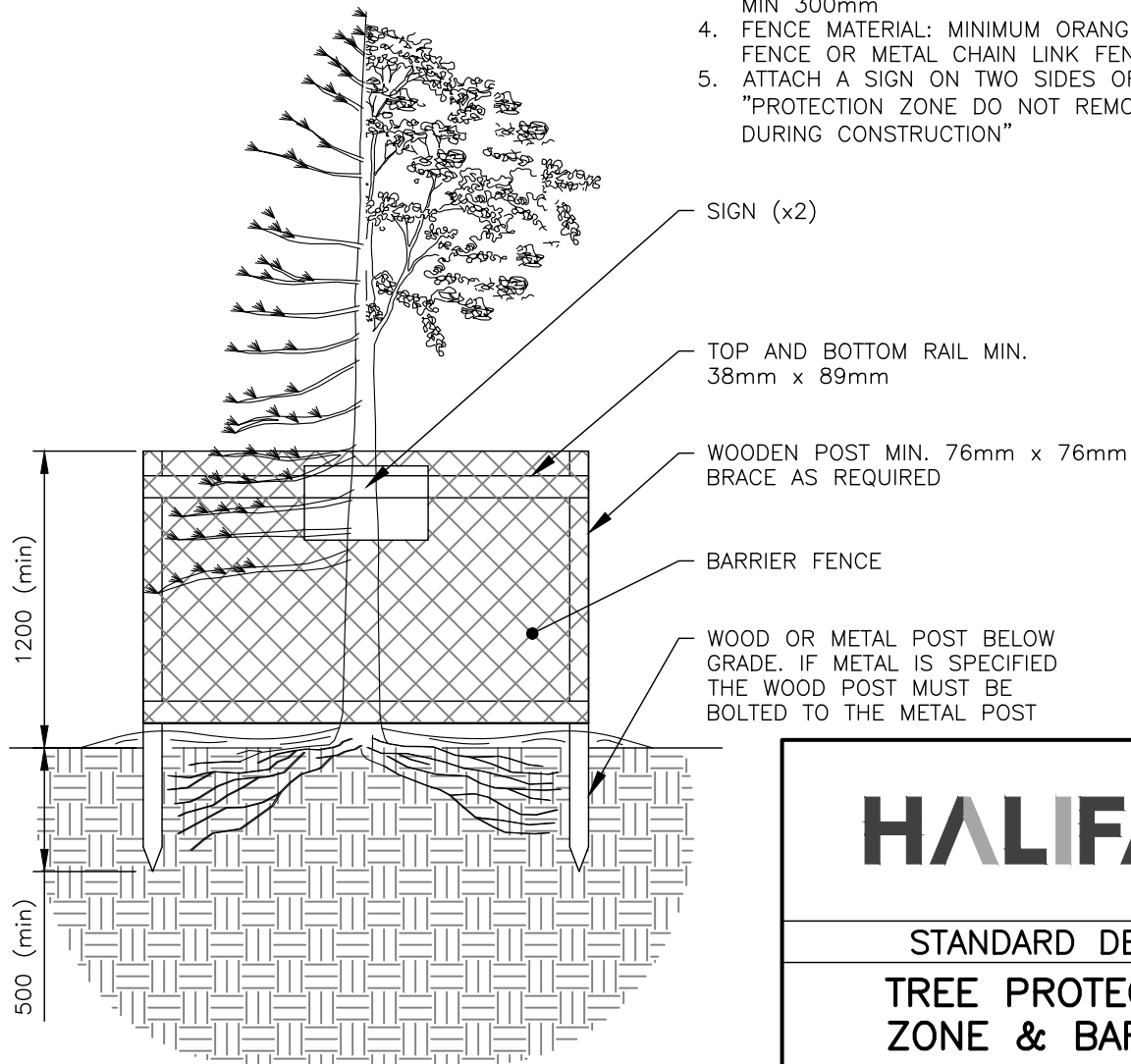

PROFILE

HALIFAX

STANDARD DETAIL

TREE PROTECTION ZONE & BARRIER

DATE:	REFERENCE	APPROVED
2021		
SCALE:		FIG No.:
NTS		HRM 140

Appendix N – Rodent Control Plan

**Bait Stations
(Pre & Post)**

CANADIAN NATIONAL RAILWAY

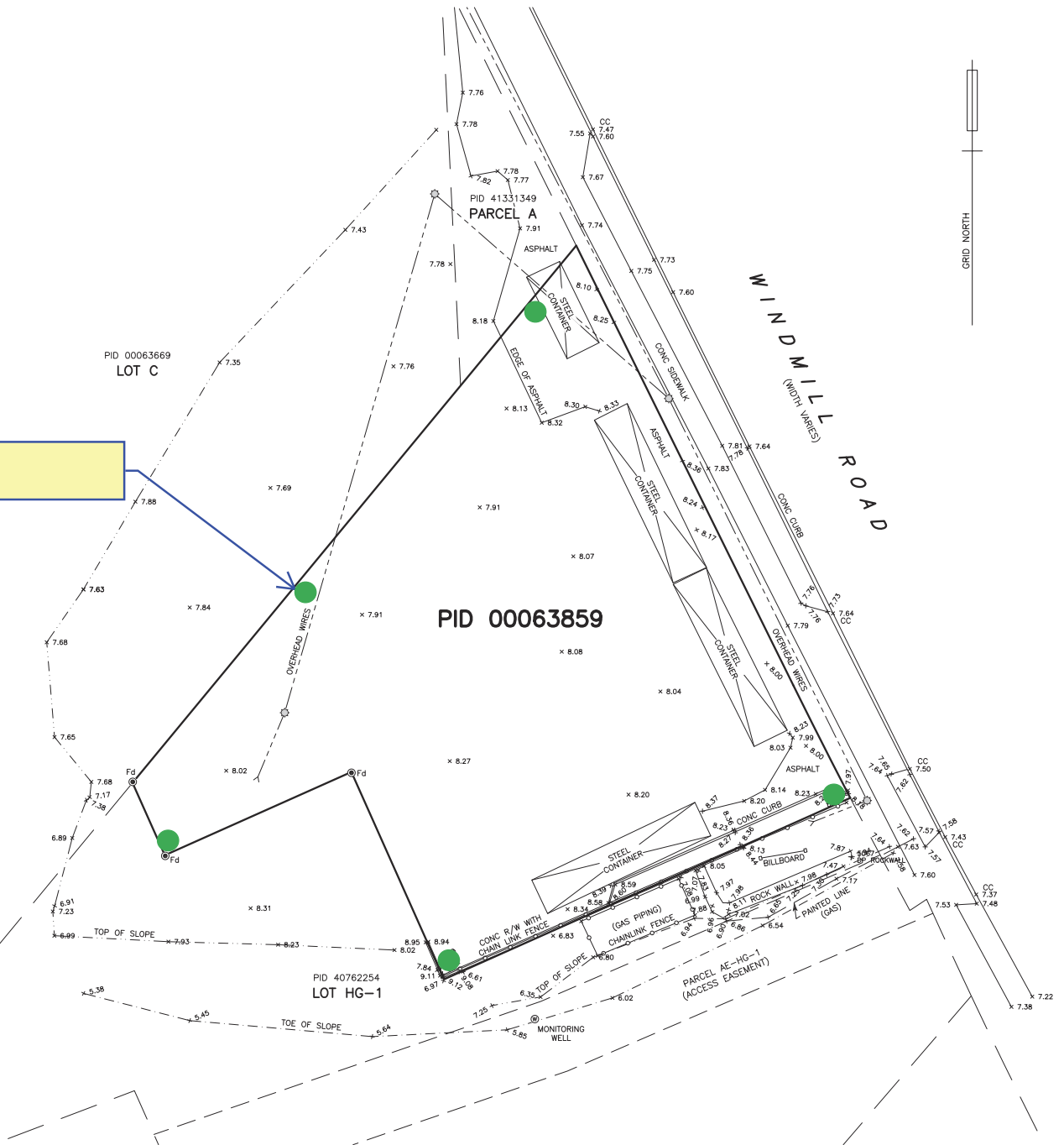

GRID NORTH

LEGEND

PERIMETER OF LANDS SURVEYED	
x123.4	SPOT ELEVATION
⊙	SURVEY MARKER
○	MANHOLE
⊠	CATCHBASIN
⌋	CULVERT INVERT
BMF/BMS	BENCHMARK FOUND/SET
⊕	UTILITY POLE & ANCHOR
⊙	LIGHT STANDARD
⊕	FIRE HYDRANT
⊕	WATER VALVE
○	BOLLARD
⌋	SIGN POST
HCLRO	HALIFAX COUNTY LAND REGISTRATION OFFICE
PID	PARCEL IDENTIFICATION NUMBER
CONC	CONCRETE
R/W	RETAINING WALL
CC	CURB CUT
Fd	FOUND
⊕	CHAINLINK FENCE
⊕	OVERHEAD WIRES
⊕	TOP OF SLOPE
⊕	TOE OF SLOPE
⊕	CENTRELINE OF DITCH/STREAM
⊕	HARDWOOD TREE
⊕	SOFTWOOD TREE

Bait Station Legend
 Pre & Post - Excavation ●
 -
 Rodent Control Plan
 -
 Prepared for
 Rentokil Atlantic
 -
 902-835-2304
 -
 51 Duke Street, Bedford, NS

Protecta®
EVO® **AMBUSH™**
 PATENT PENDING



THE MOST ADVANCED LOW-PROFILE BAIT STATION

PRODUCT FEATURES:

- ▶ Single locking mechanism for quick servicing
- ▶ Removable tray for easy cleaning
- ▶ Locking bait rods won't fall out during cleaning
- ▶ Dog & child tamper-resistant
- ▶ Can hold:
 - 4 - 1 oz. bait BLOX on 4 vertical rods
 - or -
 - T-Rex™ rat trap or Mini-Rex™ mouse trap
- ▶ Compatible with Sidekick® Load-N-Lock™ system



PRODUCT	CODE	DIMENSIONS (in)	CASE QTY
Protecta Evo Ambush	EA2000	8 1/2 x 10 1/4 x 4 1/4	6 Stations



More Than Meets The Eye

Madison, Wisconsin 53704 USA | Ph: (608) 241-0202 | Fax: (608) 241-9631

www.belllabs.com

ALL-WEATHER
BLOX™



CONTRAC®
ALL-WEATHER BLOX™

KILLS RATS, MICE & MEADOW VOLES*

Kills Warfarin Resistant Norway Rats

KEEP OUT OF REACH OF CHILDREN

CAUTION

See back panels for First Aid and additional precautionary statements.

ACTIVE INGREDIENT:

Bromadiolone (CAS #28772-56-7): 0.005%

OTHER INGREDIENTS†: 99.995%

†Contains Denatonium Benzoate TOTAL 100.000%

*Not permitted for use against the following species in California: Cotton rat, Eastern harvest mouse, Golden mouse, Polynesian rat, Meadow vole, White-throated woodrat, Southern plains woodrat, and Mexican woodrat.

NET WT:
18 lbs (8.2 kg)

FIRST AID
HAVE LABEL WITH YOU WHEN OBTAINING TREATMENT ADVICE

IF SWALLOWED:

- Call a poison control center, doctor, or 1-877-854-2494, or 1-800-858-7378** immediately for treatment advice.
- Have person sip a glass of water if able to swallow.
- Do not induce vomiting unless told to do so by the poison control center or doctor.

IF ON SKIN OR CLOTHING:

- Take off contaminated clothing. Rinse skin immediately with plenty of water for 15–20 minutes.
- Call a poison control center or doctor for treatment advice.

IF IN EYES:

- Hold eye open and rinse slowly and gently with water for 15–20 minutes.
- Remove contact lenses, if present, after the first 5 minutes, then continue rinsing eye.
- Call a poison control center, doctor, or 1-877-854-2494 immediately for treatment advice.

** Also call this number for information on health concerns and pesticide incidents.

NOTE TO PHYSICIAN

If swallowed or absorbed through the skin, this material may reduce the clotting ability of the blood and cause bleeding. If ingested, administer Vitamin K₁ intramuscularly or orally. Repeat as necessary based on monitoring of prothrombin times.

TREATMENT FOR PET POISONING
If animal eats bait, call veterinarian at once.

NOTE TO VETERINARIAN

Anticoagulant Bromadiolone: For animals ingesting bait and/or showing poisoning signs (bleeding or elevated prothrombin times), give Vitamin K₁. If needed, check prothrombin times every 3 days until values return to normal (up to 30 days). In severe cases, blood transfusions may be needed.

DIRECTIONS FOR USE

It is a violation of Federal law to use this product in a manner inconsistent with its labeling.
READ THIS LABEL: Read this entire label and follow all use directions and use precautions. Use only for sites, pests, and application methods described on this label.

IMPORTANT: Do not expose children, pets, or nontarget animals to rodenticides. To help to prevent exposure:

1. Store unused product out of reach of children and pets.
2. Apply bait in locations out of reach of children, pets, domestic animals and nontarget wildlife, or in tamper-resistant bait stations. These stations must be resistant to destruction by dogs and by children under six years of age, and must be used in a manner that prevents such children from reaching into bait compartments and obtaining bait. If bait can be shaken from bait stations when they are lifted, units must be secured or otherwise immobilized. Stronger bait stations are needed in areas open to hoofed livestock, raccoons, bears, or other potentially destructive animals, or in areas prone to vandalism.
3. Dispose of product container and unused, spoiled, or unconsumed bait as specified on this label.

Bait stations are mandatory for outdoor, above-ground use. Tamper-resistant bait stations must be used wherever children, pets, non-target mammals, or birds may have access to the bait placement location.

USE RESTRICTIONS: This product may only be used to control the following rodent pests in and around man-made structures: House mouse (*Mus musculus*), Norway rat (*Rattus norvegicus*), Roof rat (*Rattus rattus*), Cotton mouse (*Peromyscus gossypinus*), Cotton rat* (*Sigmodon hispidus*), Deer mouse (*Peromyscus maniculatus*), Eastern harvest mouse* (*Reithrodontomys humuli*), Golden mouse* (*Ochrotomys nuttalli*), Polynesian rat* (*Rattus exulans*), Meadow vole* (*Microtus pennsylvanicus*), White-footed mouse (*Peromyscus leucopus*), White-throated woodrat* (*Neotoma albigula*), Southern plains woodrat* (*Neotoma micropus*), and Mexican woodrat* (*Neotoma mexicana*). This product must be used in and within 100 feet of man-made structures constructed in a manner so as to be vulnerable to commensal rodent invasions and/or to harboring or attracting rodent infestations. Examples of such structures include homes and other permanent or temporary residences, food processing facilities, industrial and commercial buildings, trash receptacles, agricultural and public buildings, transport vehicles (ships, trains, aircraft), docks and port or terminal buildings and related structures around and associated with these sites. Fence and perimeter baiting, beyond 100 feet from a structure as defined above, is prohibited. This product must not be applied directly to food or feed crops.

587CB-9



Kills Warfarin Resistant Norway Rats

Norway rats, roof rats, and house mice may consume a lethal dose in one night's feeding with first dead rodents appearing four or five days after feeding begins.

ACTIVE INGREDIENT:
Bromadiolone (CAS #28772-56-7): 0.005%
OTHER INGREDIENTS: 99.995%
†Contains Denatonium Benzoate TOTAL 100.000%

**KEEP OUT OF REACH OF CHILDREN
CAUTION**

See side panels for First Aid and additional precautionary statements.

STORAGE AND DISPOSAL

Do not contaminate water, food or feed by storage or disposal.
Pesticide Storage: Store only in original container in a cool, dry place inaccessible to children and pets. Keep containers closed and away from other chemicals.
Pesticide Disposal: Wastes resulting from the use of this product may be placed in trash or delivered to an approved waste disposal facility.
Container Handling: Nonrefillable container. Do not reuse or refill this container. [Plastic:] Offer for recycling or reconditioning; or puncture and dispose of in a sanitary landfill; or by incineration. In most states, burning is not allowed.

WARRANTY: To the extent consistent with applicable law, seller makes no warranty, expressed or implied, concerning the use of this product other than indicated on the label. Buyer assumes all risk of use and/or handling of this material when such use and/or handling is contrary to label instructions.

NET WEIGHT: 18 lbs (8.2 kg)

EPA REG. NO. 12455-79

EPA EST. NO. 12455-WI-1



DIRECTIONS FOR USE (Continued from other panel)

Burrow baiting with Contrac All-Weather Blox is prohibited.

Do not place near or inside ventilation duct openings. Do not contaminate water, food, feedstuffs, food or feed handling equipment, or milk or meat handling equipment or surfaces that come into direct contact with food. When used in USDA inspected facilities, this product must be applied in tamper-resistant bait stations. Do not broadcast bait. Do not use this product in sewers.

Do not sell this product in individual containers holding less than 16 pounds of bait.

SELECTION OF TREATMENT AREAS: Determine areas where rats, mice, or meadow voles* will most likely find and consume the bait. Generally, these areas are along walls, by gnawed openings, in corners and concealed places, between floors and walls, or in locations where rats, mice, or meadow voles*, or their signs have been seen. Protect bait from rain and snow. Remove as much alternative food as possible.

APPLICATION DIRECTIONS:

RATS: Place 3 to 16 bait blocks (at intervals of 15 to 30 feet) per placement in infested areas. Maintain an uninterrupted supply of fresh bait for at least 10 days or until signs of rat activity cease.

MICE AND MEADOW VOLES*: Place 1 block per placement. Space placements at 8- to 12-foot intervals in infested areas. Two blocks may be needed at points of very high activity. Maintain an uninterrupted supply of fresh bait for at least 15 days or until signs of mouse or meadow vole* activity cease.

FOLLOW-UP: Replace contaminated or spoiled bait immediately. Wearing gloves, collect and dispose of all dead, exposed animals and leftover bait. To prevent reinfestation, limit sources of rodent food, water, and harborage as much as possible. If reinfestation does occur, repeat treatment. Where a continuous source of infestation is present, establish permanent bait stations and replenish as needed.

**PRECAUTIONARY STATEMENTS
HAZARDS TO HUMANS AND DOMESTIC ANIMALS**

CAUTION: Harmful if swallowed or absorbed through the skin. Keep away from children, domestic animals and pets. Do not get in eyes, on skin or on clothing.

All handlers (including applicators) must wear: shoes plus socks, and waterproof gloves. Any person who retrieves carcasses or unused bait following application of this product must wear gloves.

User Safety Requirements

Follow manufacturer's instruction for cleaning/maintaining PPE. If no such instructions for washables, use detergent and hot water. Keep and wash PPE separately from other laundry. Remove PPE immediately after handling this product. Wash the outside of gloves before removing. As soon as possible, wash hands thoroughly after applying bait and before eating, drinking, chewing gum, using tobacco or using the toilet and change into clean clothing.

ENVIRONMENTAL HAZARDS

This product is extremely toxic to fish, birds and other wildlife. Dogs and predatory and scavenging mammals and birds might be poisoned if they feed upon animals that have eaten this bait. Do not apply this product directly to water or to areas where surface water is present or to intertidal areas below the mean high water mark. Runoff also may be hazardous to aquatic organisms in water adjacent to treated areas. Do not contaminate water when disposing of equipment wash water or rinsate.

*Not permitted for use against the following species in California: Cotton rat, Eastern harvest mouse, Golden mouse, Polynesian rat, Meadow vole, White-throated woodrat, Southern plains woodrat, and Mexican woodrat.

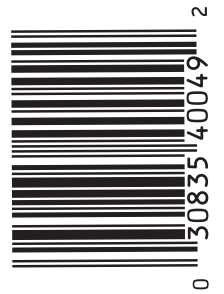

Product Code: CB4051

090415/09-15



DETEX[®] BLOX with LUMITRACK

SAFETY DATA SHEET

ACCORDING TO REGULATION: OSHA
Hazard Communication Standard 29 CFR 1910.1200

DATE OF ISSUE:
January 2016

PREPARED BY:
CAR

SECTION 1. PRODUCT AND COMPANY IDENTIFICATION

Product Identifier: DETEX[®] BLOX with LUMITRACK
EPA Registration Number: NA
Relevant identified uses of the substance or mixture and uses advised against
Relevant identified uses: Activity Monitoring - Ready to use
Uses advised against: Use only for the purpose described above

MANUFACTURER/SUPPLIER:

Bell Laboratories, Inc.
3699 Kinsman Blvd.
Madison, WI 53704, USA
Email: sds@belllabs.com
Phone: 608-241-0202
Medical or Vet Emergency: 877-854-2494 or 952-852-4636
Spill or Transportation Emergency: 800-424-9300 (CHEMTREC)

SECTION 2. HAZARDS IDENTIFICATION

Classification according to Regulation OSHA 1910.1200(d): Not classified
Signal Word: None
See Section 15 for information on FIFRA applicable safety, health, and environmental classifications.

SECTION 3. COMPOSITION/INFORMATION ON INGREDIENTS

Component	CAS No.	% By weight
Inert and Non-Hazardous Ingredients (Unlisted components are non-hazardous)	Proprietary	100.00%

SECTION 4. FIRST AID MEASURES

Description of first aid measures
Ingestion: Non-Toxic
Inhalation: Not applicable.
Eye contact: Non-Toxic
Skin contact: Non-Toxic
Most important symptoms and effects, both acute and delayed
Non-Toxic
Advice to physician: Non-Toxic
Advice to Veterinarian: Non-Toxic

SECTION 5. FIRE-FIGHTING MEASURES

Extinguishing media
Suitable Extinguishing Media: water, foam or inert gas.
Unsuitable Extinguishing Media: None known.
Special hazards arising from the mixture: High temperature decomposition or burning in air can result in the formation of toxic gases, which may include carbon monoxide.
Advice for firefighters: Wear protective clothing and self-contained breathing apparatus.

SECTION 6. ACCIDENTAL RELEASE MEASURES

Personal precautions, protective equipment and emergency procedures: None. Non-Toxic
Environmental precautions: None. Non-Toxic
Methods and materials for containment and cleaning up
For Containment: None. Non-Toxic
For Cleaning Up: None. Non-Toxic
Reference to other sections: Refer to Sections 7, 8 & 13 for further details of personal precautions, personal protective equipment and disposal considerations.

SECTION 7. HANDLING AND STORAGE

Precautions for safe handling: Do not use near heat sources, open flame, or hot surfaces. Non-Toxic.

Conditions for safe storage, including any incompatibilities: None. Non-Toxic

SECTION 8. EXPOSURE CONTROLS/PERSONAL PROTECTION

Established Limits

Component	OSHA	ACGIH	Other Limits
None	Not Established	Not Established	Not Established

Appropriate Engineering Controls: None. Non-Toxic

Occupational exposure limits: None. Non-Toxic

Personal Protective Equipment:

Respiratory protection: Not required

Eye protection: Not required

Skin protection: None. Non-Toxic

Hygiene recommendations: None. Non-Toxic

SECTION 9. PHYSICAL AND CHEMICAL PROPERTIES

Information on basic physical and chemical properties

Appearance/Color:	Tan wax block
Odor:	Sweet grain-like
Odor Threshold:	Not applicable, odor not associated with a hazardous material.
pH:	Not applicable, is not dispersible with water.
Melting point:	Not applicable
Boiling point:	Not applicable
Flash point:	Not applicable, does not contain components classified as flammable.
Evaporation rate:	Not applicable, is a solid.
Flammability:	Not applicable, is a solid.
Upper/lower flammability or explosive limits:	Not applicable, does not contain components classified as flammable or explosive.
Vapor Pressure:	Not applicable
Vapor Density:	Not applicable, is a solid
Relative Density:	1.13 g/mL @ 20°C
Solubility (water):	Not water soluble
Solubility (solvents):	Not applicable
Partition coefficient: n-octanol/water:	Not applicable
Auto-ignition temperature:	Not applicable, does not contain components classified as flammable.
Decomposition temperature:	Not applicable
Viscosity:	Not applicable, is not a liquid.

SECTION 10. STABILITY AND REACTIVITY

Reactivity: Not Applicable

Chemical stability: Not Applicable

Possibility of hazardous reactions: Refer to Hazardous decomposition products

Conditions to avoid: Avoid extreme temperatures (below 0°C or above 40°C).

Incompatible materials: Not Applicable

Hazardous decomposition products: Not Applicable

SECTION 11. TOXICOLOGICAL INFORMATION

Information on toxicological effects

Acute Toxicity

LD50, oral (ingestion): Not Toxic

LD50, dermal (skin contact): Not Toxic

LC50, inhalation: Not Toxic

Skin corrosion/irritation: Not Toxic

Serious eye damage/Irritation: Not Toxic.

Respiratory or skin sensitization: Not Toxic

Germ cell mutagenicity: Not Toxic

Carcinogenicity: Not Toxic

Components	NTP	IARC	OSHA
None	NA	NA	NA

Reproductive Toxicity: Not Toxic
Aspiration Hazard: Not Toxic
Target Organ Effects: Not Toxic

SECTION 12. ECOLOGICAL INFORMATION

Ecotoxicity Effects: Not Toxic
Persistence and degradability: Not Toxic
Bioaccumulative potential: Not Toxic
Mobility in Soil: Not Toxic.
Other adverse effects: None.

SECTION 13. DISPOSAL CONSIDERATIONS

Disposal: Wastes resulting from the use of this product may be placed in trash, on-site, or at an approved waste disposal facility. Dispose of all wastes in accordance with all Federal, state and local regulations.

SECTION 14. TRANSPORT INFORMATION

UN number: Not regulated
UN proper shipping name: Not regulated
Transport hazard class(es): Not regulated
Packing group : Not regulated
Environmental Hazards
DOT Road/Rail: Not considered hazardous for transportation via road/rail.
DOT Maritime: Not considered hazardous for transportation by vessel.
DOT Air: Not considered hazardous for transportation by air.
Freight Classification: LTL Class 60
Transport in bulk according to Annex II of MARPOL 73/78 and the IBC code: Not applicable
Special precautions for user: None

SECTION 15. REGULATORY INFORMATION

Safety, health and environmental regulations/legislation specific for the substance or mixture: Not applicable
Signal Word: None
Precautionary Statements: None
Potential Health Effects:
Eye Contact: May cause irritation
Skin Contact: Non-irritating to the skin
Ingestion: Not harmful if swallowed

TSCA: All components are listed on the TSCA Inventory or are not subject to TSCA requirements
CERCLA/SARA 313: Not Toxic
CERCLA/SARA 302: Not Toxic

SECTION 16. OTHER INFORMATION

For additional information, please contact the manufacturer noted in Section 1.

NFPA	Health: 0 (Not Toxic)	Flammability: 1 (slight)	Reactivity: 0 (stable)	Specific Hazard: None
HMIS	Health: 0 (Not Toxic)	Flammability: 1 (slight)	Reactivity: 0 (minimal)	Protective Equipment: None

Disclaimer: The information provided in this Safety Data Sheet has been obtained from sources believed to be reliable. Bell Laboratories, Inc. provides no warranties; either expressed or implied, and assumes no responsibility for the accuracy or completeness of the data contained herein. This information is offered for your consideration and investigation. The user is responsible to ensure that they have all current data, including the approved product label, relevant to their particular use.

Appendix O – CMP’s TCP & PMP Inspection Records

Appendix P – Concrete Delivery Schematic

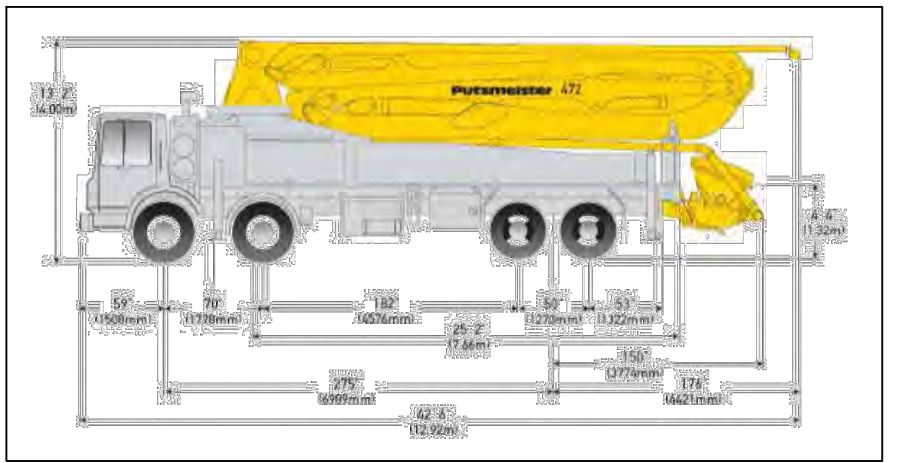

47Z

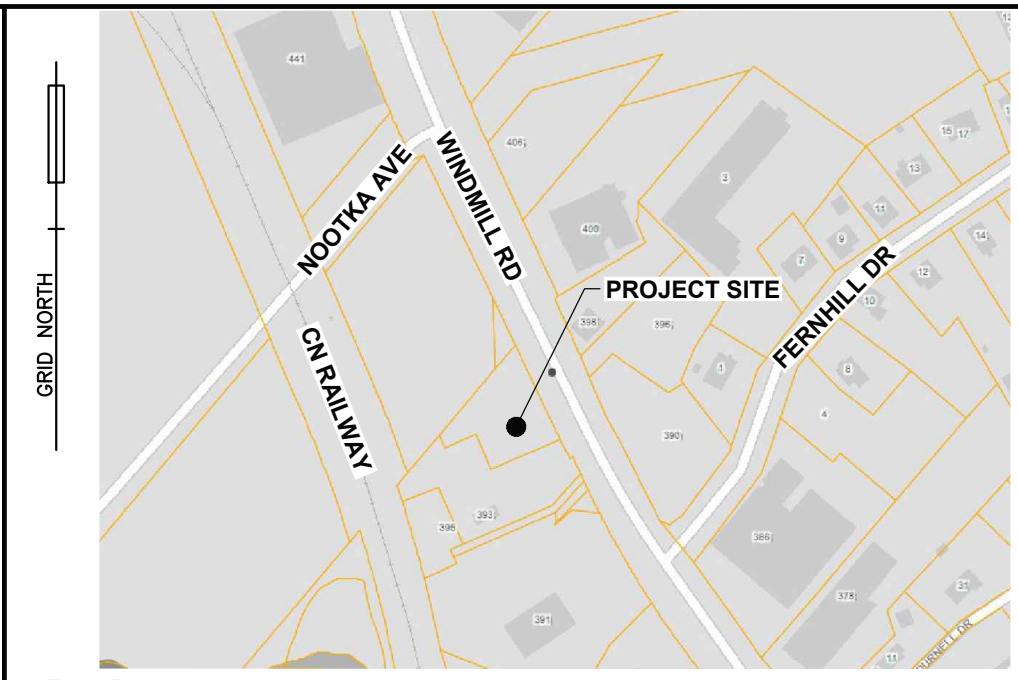
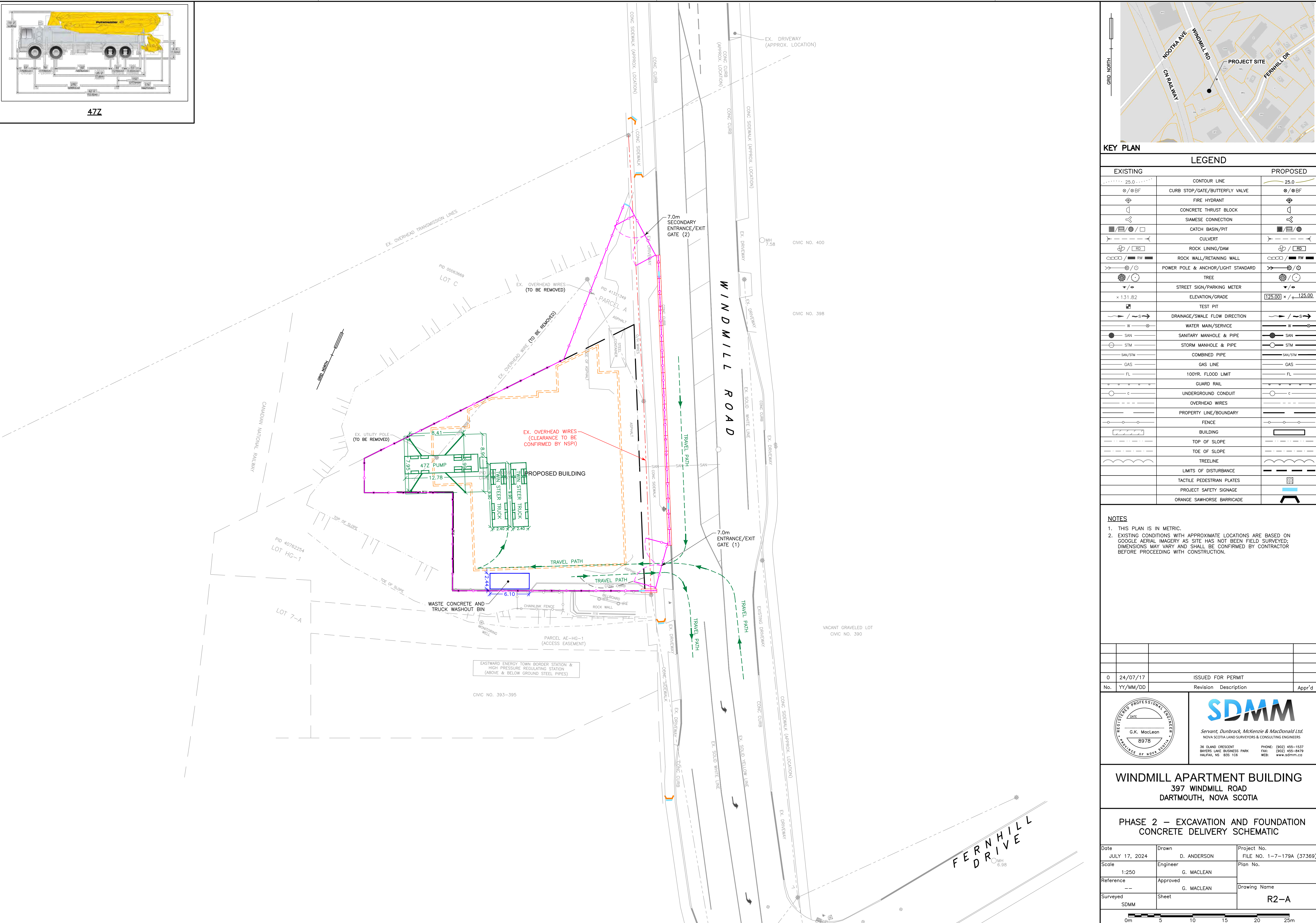

KEY PLAN

LEGEND

EXISTING	PROPOSED	
25.0	CONTOUR LINE	25.0
⊙/⊙BF	CURB STOP/GATE/BUTTERFLY VALVE	⊙/⊙BF
⊙	FIRE HYDRANT	⊙
⊔	CONCRETE THRUST BLOCK	⊔
⊔	SIAMESE CONNECTION	⊔
⊔	CATCH BASIN/PIT	⊔
⊔	CULVERT	⊔
⊔	ROCK LINING/DAM	⊔
⊔	ROCK WALL/RETAINING WALL	⊔
⊔	POWER POLE & ANCHOR/LIGHT STANDARD	⊔
⊔	TREE	⊔
⊔	STREET SIGN/PARKING METER	⊔
⊔	ELEVATION/GRADE	⊔
⊔	TEST PIT	⊔
⊔	DRAINAGE/SWALE FLOW DIRECTION	⊔
W	WATER MAIN/SERVICE	W
SAN	SANITARY MANHOLE & PIPE	SAN
STM	STORM MANHOLE & PIPE	STM
SAW/STM	COMBINED PIPE	SAW/STM
FL	GAS LINE	FL
FL	100YR. FLOOD LIMIT	FL
⊔	GUARD RAIL	⊔
⊔	UNDERGROUND CONDUIT	⊔
⊔	OVERHEAD WIRES	⊔
⊔	PROPERTY LINE/BOUNDARY	⊔
⊔	FENCE	⊔
⊔	BUILDING	⊔
⊔	TOP OF SLOPE	⊔
⊔	TOE OF SLOPE	⊔
⊔	TREELINE	⊔
⊔	LIMITS OF DISTURBANCE	⊔
⊔	TACTILE PEDESTRIAN PLATES	⊔
⊔	PROJECT SAFETY SIGNAGE	⊔
⊔	ORANGE SANHORSE BARRICADE	⊔

NOTES

- THIS PLAN IS IN METRIC.
- EXISTING CONDITIONS WITH APPROXIMATE LOCATIONS ARE BASED ON GOOGLE AERIAL IMAGERY AS SITE HAS NOT BEEN FIELD SURVEYED; DIMENSIONS MAY VARY AND SHALL BE CONFIRMED BY CONTRACTOR BEFORE PROCEEDING WITH CONSTRUCTION.

0	24/07/17	ISSUED FOR PERMIT	
No.	YY/MM/DD	Revision Description	Appr'd

REGISTERED PROFESSIONAL ENGINEER

G.K. MacLean

8978

PROFESSIONAL SOCIETY OF NOVA SCOTIA

SDMM

Servant, Dunbrack, McKenzie & MacDonald Ltd.

NOVA SCOTIA LAND SURVEYORS & CONSULTING ENGINEERS

36 QUINN CRESCENT
BIRDS LAKE BUSINESS PARK
HALIFAX, NS B3S 1G6

PHONE: (902) 455-1537
FAX: (902) 455-9479
WEB: www.sdmm.co

WINDMILL APARTMENT BUILDING
397 WINDMILL ROAD
DARTMOUTH, NOVA SCOTIA

**PHASE 2 – EXCAVATION AND FOUNDATION
CONCRETE DELIVERY SCHEMATIC**

Date	Drawn	Project No.
JULY 17, 2024	D. ANDERSON	FILE NO. 1-7-179A (37369)
Scale	Engineer	Plan No.
1:250	G. MACLEAN	
Reference	Approved	Drawing Name
--	G. MACLEAN	R2-A
Surveyed	Sheet	
SDMM		

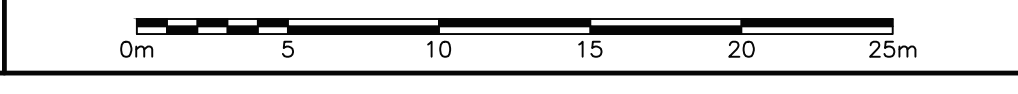

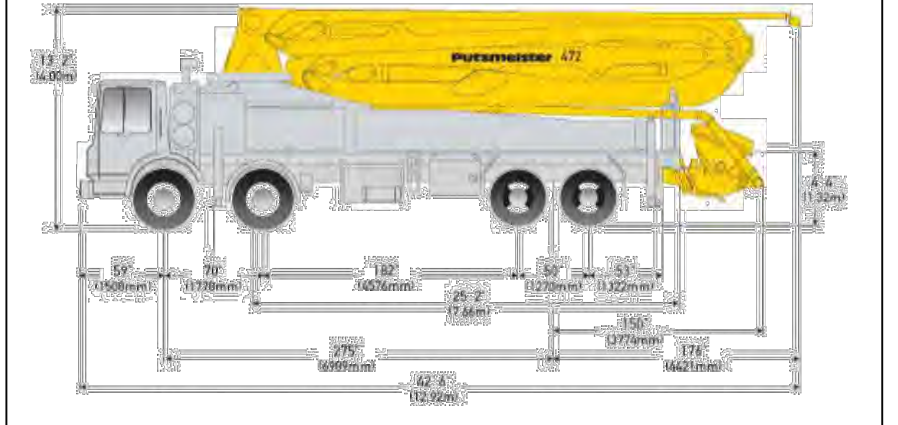

477

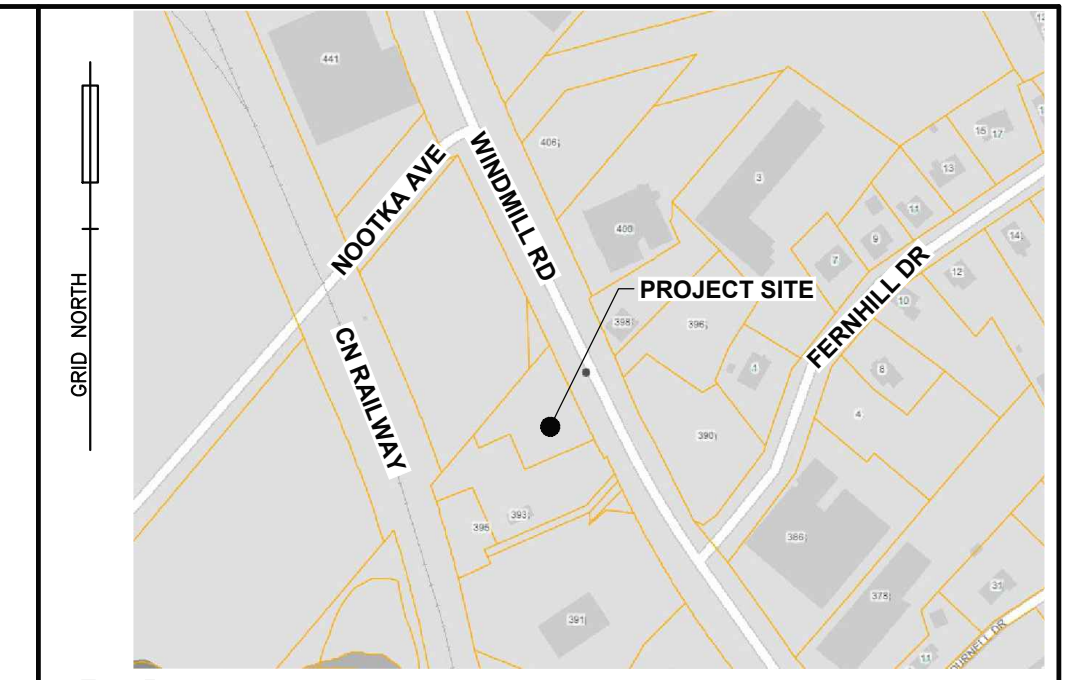

KEY PLAN

LEGEND

EXISTING	PROPOSED	
25.0	CONTOUR LINE	25.0
⊙/⊙BF	CURB STOP/GATE/BUTTERFLY VALVE	⊙/⊙BF
⊙	FIRE HYDRANT	⊙
⊔	CONCRETE THRUST BLOCK	⊔
⊔	SIAMESE CONNECTION	⊔
⊔	CATCH BASIN/PIT	⊔
⊔	CULVERT	⊔
⊔	ROCK LINING/DAM	⊔
⊔	ROCK WALL/RETAINING WALL	⊔
⊔	POWER POLE & ANCHOR/LIGHT STANDARD	⊔
⊔	TREE	⊔
⊔	STREET SIGN/PARKING METER	⊔
× 131.82	ELEVATION/GRADE	[125.00] × / 125.00
⊔	TEST PIT	⊔
⊔	DRAINAGE/SWALE FLOW DIRECTION	⊔
W	WATER MAIN/SERVICE	W
SAN	SANITARY MANHOLE & PIPE	SAN
STM	STORM MANHOLE & PIPE	STM
SAW/STM	COMBINED PIPE	SAW/STM
GAS	GAS LINE	GAS
FL	100YR. FLOOD LIMIT	FL
⊔	GUARD RAIL	⊔
⊔	UNDERGROUND CONDUIT	⊔
⊔	OVERHEAD WIRES	⊔
⊔	PROPERTY LINE/BOUNDARY	⊔
⊔	FENCE	⊔
⊔	BUILDING	⊔
⊔	TOP OF SLOPE	⊔
⊔	TOE OF SLOPE	⊔
⊔	TREELINE	⊔
⊔	LIMITS OF DISTURBANCE	⊔
⊔	TACTILE PEDESTRIAN PLATES	⊔
⊔	PROJECT SAFETY SIGNAGE	⊔
⊔	ORANGE SANHORSE BARRICADE	⊔

NOTES

- THIS PLAN IS IN METRIC.
- EXISTING CONDITIONS WITH APPROXIMATE LOCATIONS ARE BASED ON GOOGLE AERIAL IMAGERY AS SITE HAS NOT BEEN FIELD SURVEYED; DIMENSIONS MAY VARY AND SHALL BE CONFIRMED BY CONTRACTOR BEFORE PROCEEDING WITH CONSTRUCTION.

No.	YY/MM/DD	Revision	Description	Appr'd
2	24/07/17	REVISED PHASE AS PER HRM COMMENTS		
1	24/03/15	ISSUED FOR PERMIT		
0	23/02/23	ISSUED FOR REVIEW		



WINDMILL APARTMENT BUILDING
397 WINDMILL ROAD
DARTMOUTH, NOVA SCOTIA

PHASE 3 – BUILDING CONSTRUCTION
CONCRETE DELIVERY SCHEMATIC

Date	Drawn	Project No.
FEBRUARY 23, 2023	D. ANDERSON	FILE NO. 1-7-179A (37369)
Scale	Engineer	Plan No.
1:250	G. MACLEAN	
Reference	Approved	Drawing Name
--	G. MACLEAN	R2-B
Surveyed	Sheet	
SDMM		

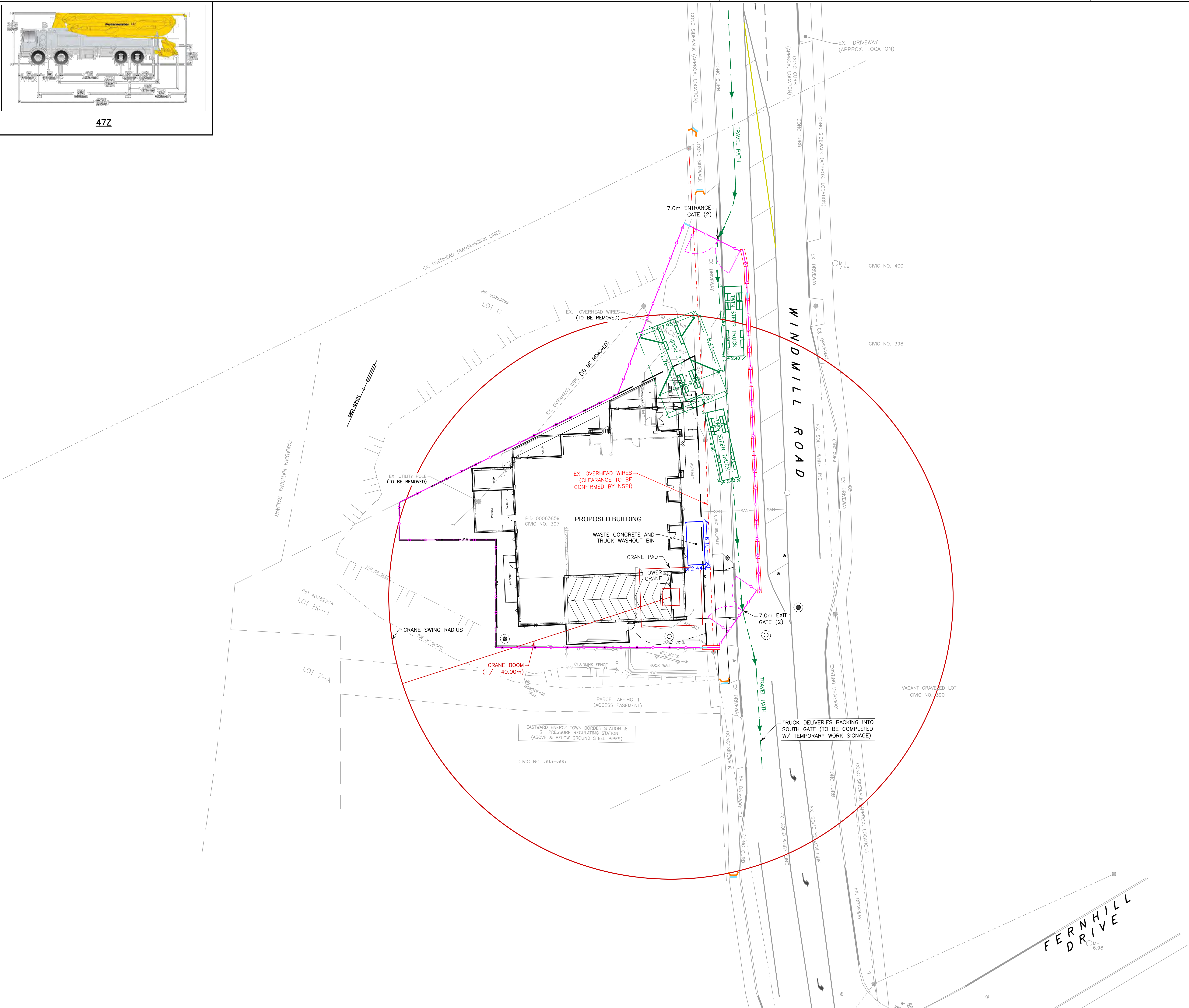
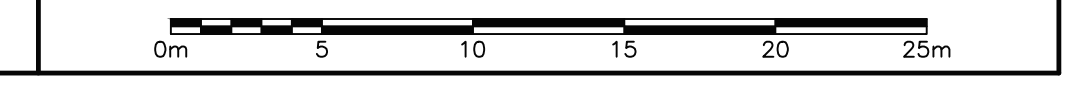

Appendix Q – Crane Information

Crane Operations



Crane Radius

Crane Base & Tower

Crane boom (+/- 40m)

Crane Operations

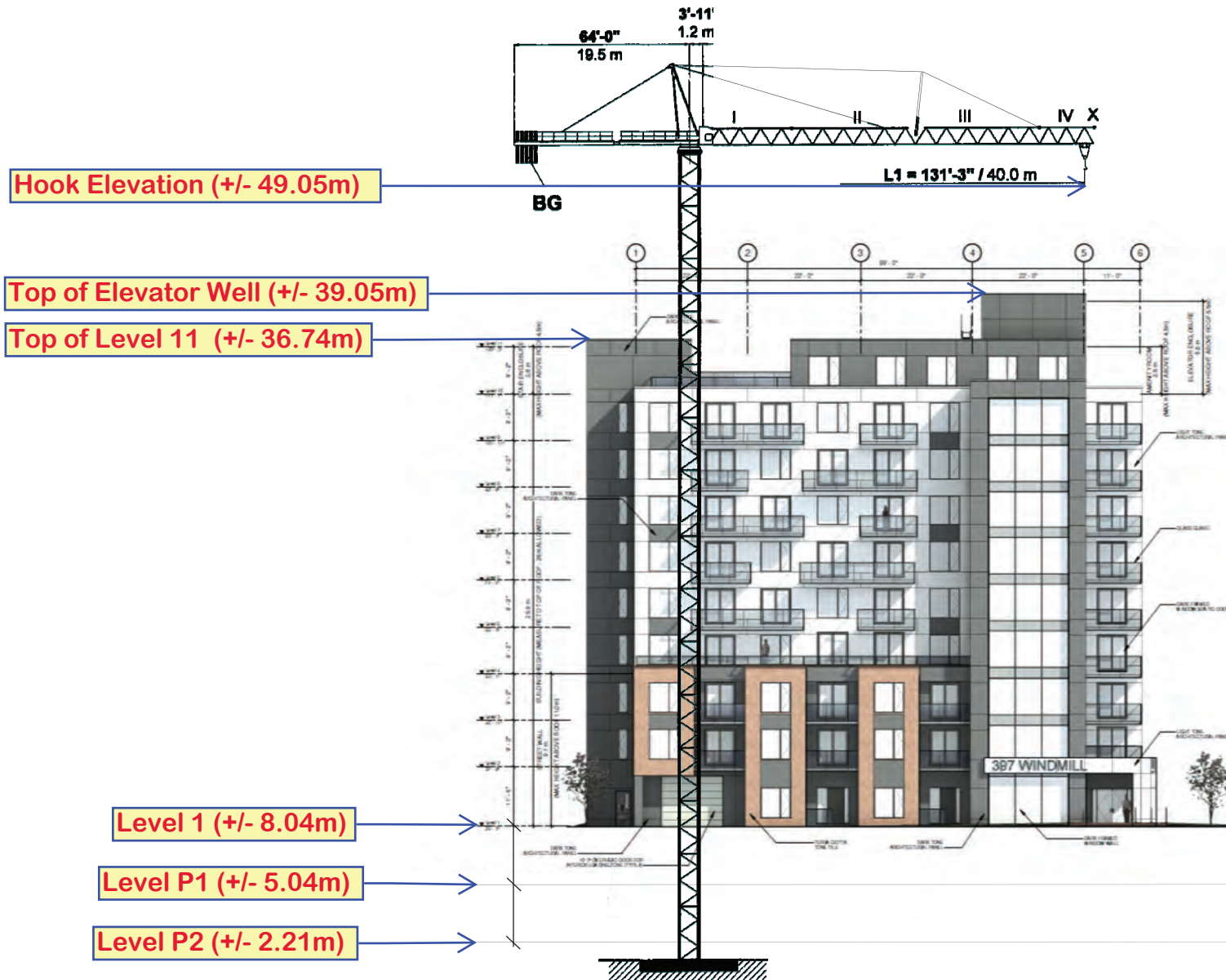



PEINER SK 315

Hammerhead Tower Crane
17,600-35,300 lbs. (8-16 mt)
Lifting Capacity

SPECIFICATIONS

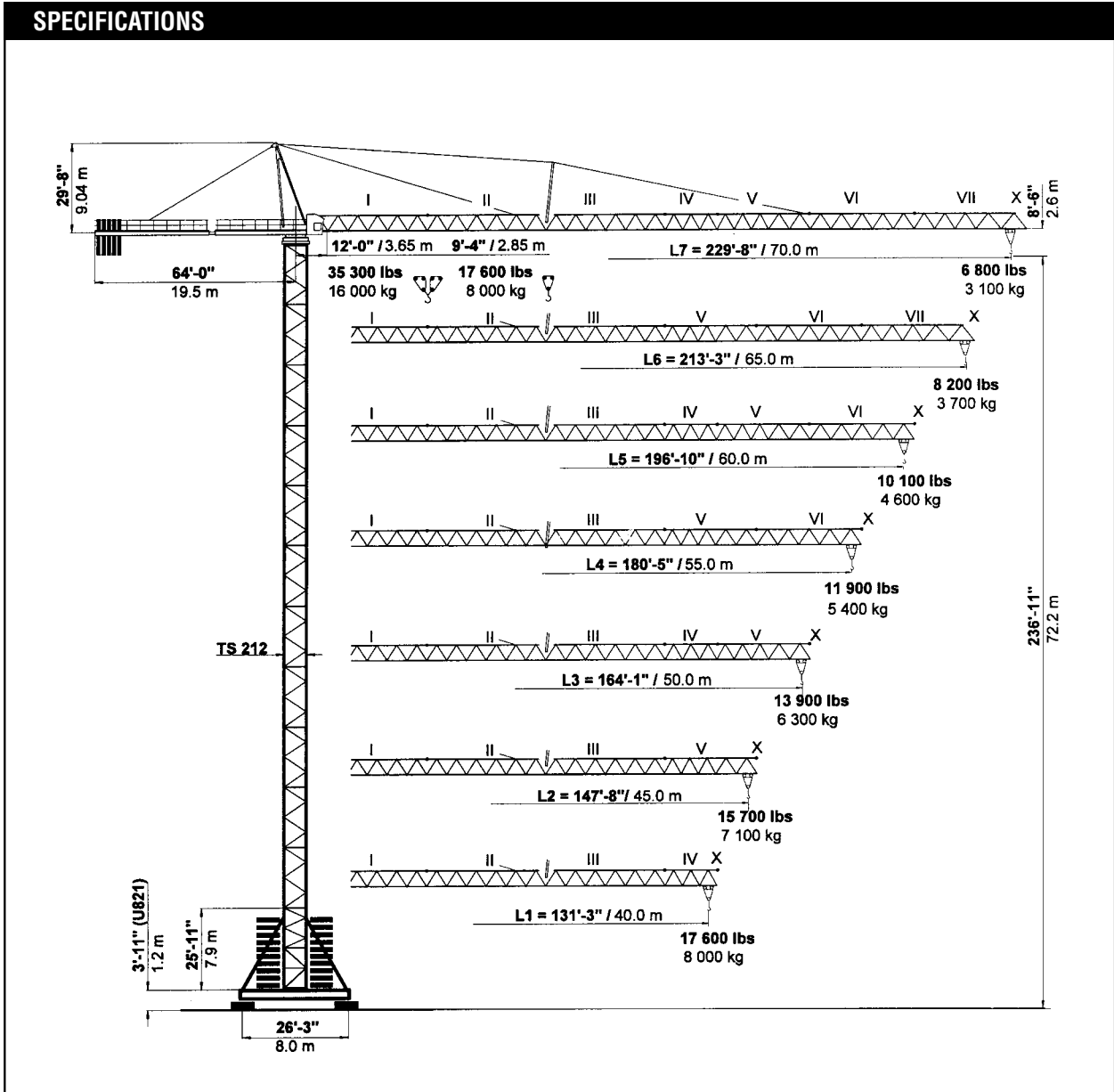

simple, available and
 cost effective™

Machines shown may have optional equipment.



PEINER SK 315

Combinations of tower section, hook heights, forces acting per corner, base ballast

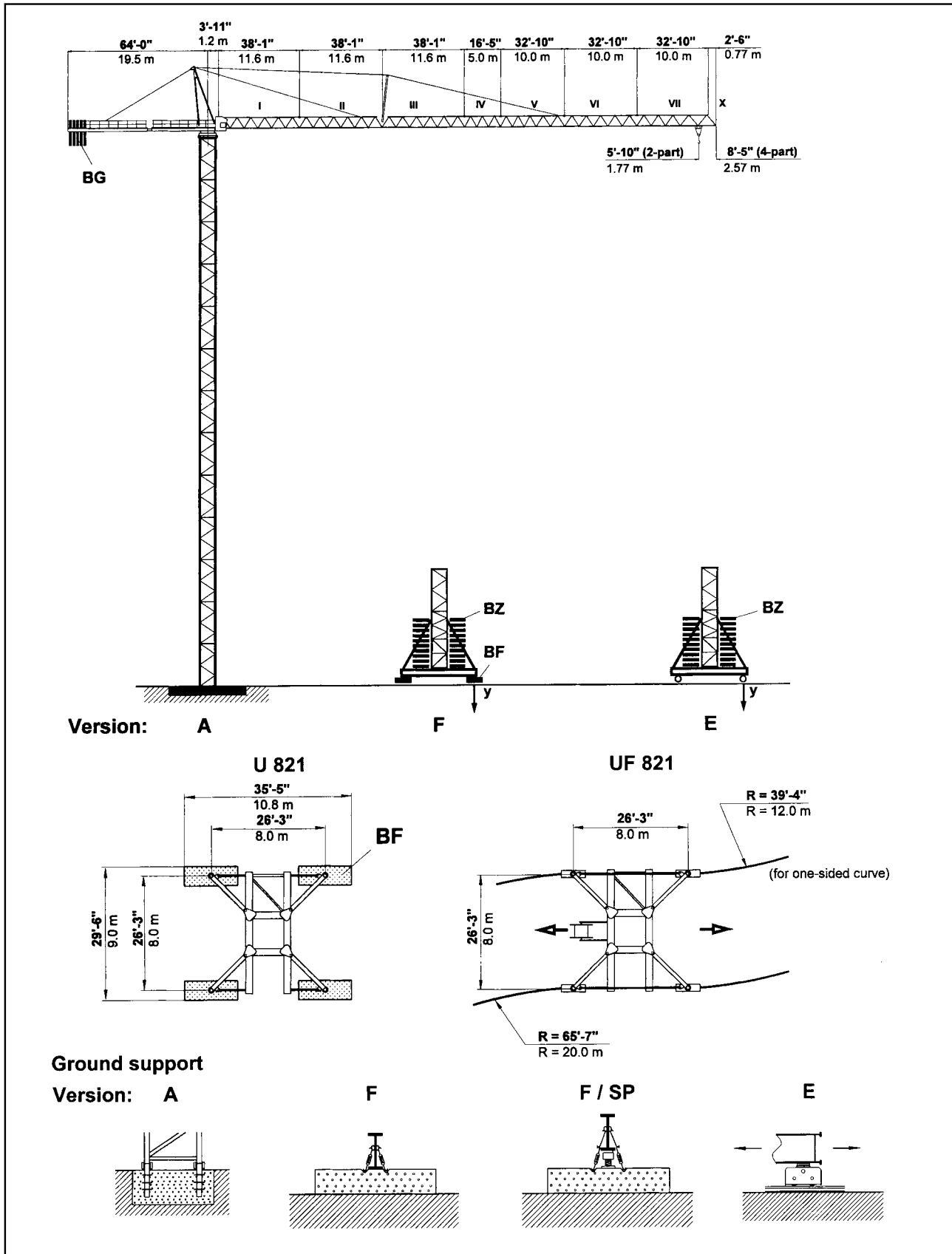

PEINER SK 315 Tower TS 211

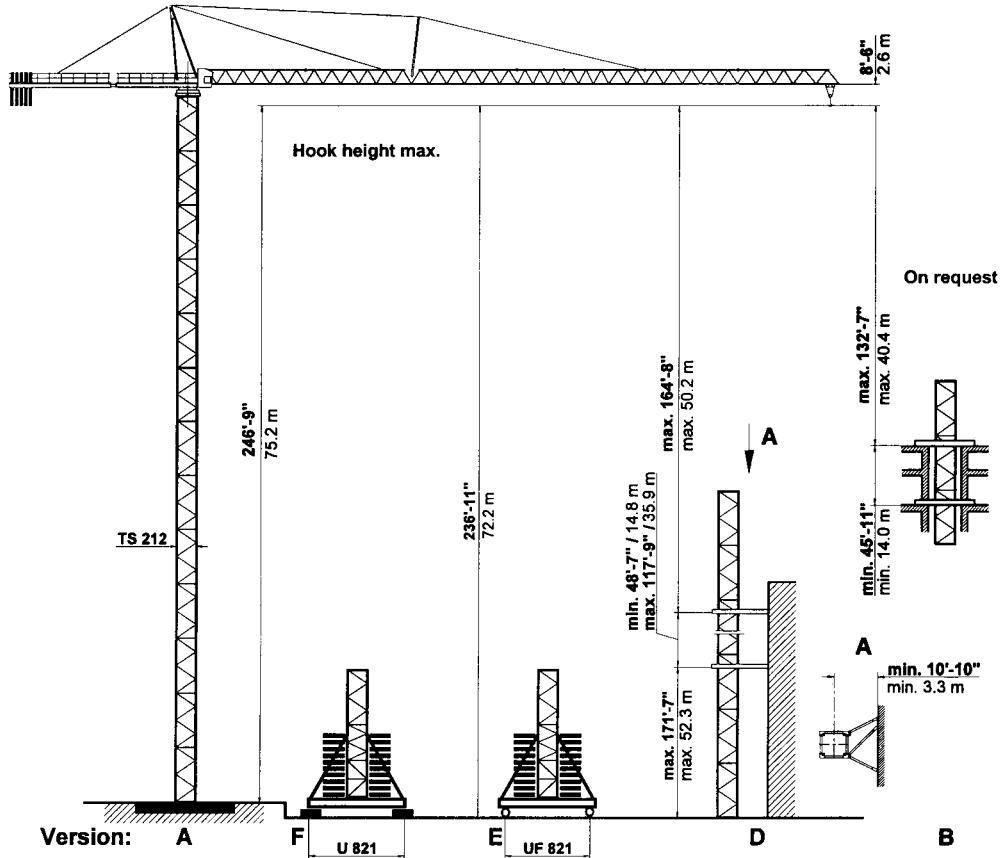

TS 212	Version A		Version F			Version E			
	HH	Tower	HH	BZ + BF	in service	out of service	BZ	in service	out of service
TS 212.1	ft m	TSV 212 TS 212.1	ft m	kips / t	kips / kN	kips / kN	kips / t	kips / kN	kips / kN
13 x TS 212.1	246'-9"*** 75.2*								
12 x TS 212.1	227'-4"*** 69.3*	1 x TSV 212 11 x TS 212.1	236'-11"*** 72.2*	212.0 96	204 909	279 1243	198.0 90	212 942	282 1253
11 x TS 212.1	208'-0"*** 63.4*	1 x TSV 212 10 x TS 212.1	217'-6"*** 66.3*	168.0 76	186 826	240 1066	154.0 70	192 856	242 1075
10 x TS 212.1	188'-8"*** 57.5*	1 x TSV 212 9 x TS 212.1	198'-2"*** 60.4	146.0 66	173 770	203 901	132.0 60	179 797	204 909
9 x TS 212.1	169'-4"*** 51.6	1 x TSV 212 8 x TS 212.1	178'-10"*** 54.5	124.0 56	161 715	169 751	88.0 40	161 715	169 754
8 x TS 212.1	149'-11"*** 45.7	1 x TSV 212 7 x TS 212.1	159'-5"*** 48.6	101.0 46	149 661	145 645	88.0 40	154 683	170 654
7 x TS 212.1	130'-7"*** 39.8	1 x TSV 212 6 x TS 212.1	140'-1"*** 42.7	101.0 46	142 633	128 569	66.0 30	141 629	124 553
6 x TS 212.1	111'-3"*** 33.9	1 x TSV 212 5 x TS 212.1	120'-9"*** 36.8	101.0 46	136 607	112 499	66.0 30	135 600	108 482
5 x TS 212.1	91'-10"*** 28.0	1 x TSV 212 4 x TS 212.1	101'-5"*** 30.9	101.0 46	131 582	98 435	66.0 30	129 573	94 418
4 x TS 212.1	72'-6"*** 22.1	1 x TSV 212 3 x TS 212.1	82'-0"*** 25.0	101.0 46	126 559	85 376	66.0 30	123 548	81 359
3 x TS 212.1	53'-2"*** 16.2	1 x TSV 212 2 x TS 212.1	62'-8"*** 19.1	101.0 46	120 536	80 356	66.0 30	118 523	75 335
2 x TS 212.1	33'-9"*** 10.3	1 x TSV 212 1 x TS 212.1	43'-4"*** 13.2	101.0 46	116 515	80 356	66.0 30	112 500	75 335
Foundation 25'-7" x 25'-7" x 5'-7" 7.8 x 7.8 x 1.7 m					Stationary base U 821		Travelling base UF 821		
Anchor stools 4 x FF 212					BF 4 x 8.82 kips 4 x 4.0 t		BZ block 11.02 kips Block 5.0 t		Bogle Curve F 500

If TSK 212 section is used the hook height is increased by 6'-7" (2 m).

* Lower climbing section after erection.

TS 212.1 = 19'-4 1/4" / 5.9 m

TSV 212 = 25'-11" / 7.9 m

TSK 212 = 6'-7" / 2.0 m



PEINER SK 315 Radius and Capacity

Jib	Max. capacity max. 17,600 lbs 8.0 t	Radius – ft./m Capacity – lbs./mt																			
		2-Part Line max. 17,600 lbs max. 8.0 t																			
ft m		75'-6" 23	82'-0" 25	98'-5" 30	114'-10" 35	131'-3" 40	141'-1" 43	147'-8" 45	157'-6" 48	164'-1" 50	173'-11" 53	180'-5" 55	190'-3" 58	196'-10" 60	206'-8" 63	213'-3" 65	223'-1" 68	229'-8" 70			
L7	229'-8" 70.0	9'-4" - 96'-9" 2.85 - 29.5 m	17600 8.0	17600 8.0	17400 7.9	14800 6.7	12800 5.8	11900 5.4	11200 5.1	10600 4.8	10100 4.6	9500 4.3	9000 4.1	8600 3.9	8200 3.7	7700 3.5	7500 3.4	7100 3.2	6800 3.1		
L6	213'-3" 65.0	9'-4" - 105'-0" 2.85 - 32.0 m	17600 8.0	17600 8.0	17600 8.0	16100 7.3	13900 6.3	13000 5.9	12300 5.6	11500 5.2	11000 5.0	10400 4.7	9900 4.5	9300 4.2	8800 4.0	8600 3.9	8200 3.7				
L5	196'-10" 60.0	9'-4" - 117'-9" 2.85 - 35.9 m	17600 8.0	17600 8.0	17600 8.0	17600 8.0	15700 7.1	14600 6.6	13900 6.3	13000 5.9	12300 5.6	11700 5.3	11200 5.1	10600 4.8	10100 4.6						
L4	180'-5" 55.0	9'-4" - 124'-8" 2.85 - 38.0 m	17600 8.0	17600 8.0	17600 8.0	17600 8.0	16800 7.6	15400 7.0	14800 6.7	13900 6.3	13200 6.0	12300 5.6	11900 5.4								
L3	164'-1" 50.0	9'-4" - 130'-11" 2.85 - 39.9 m	17600 8.0	17600 8.0	17600 8.0	17600 8.0	17600 8.0	16300 7.4	15400 7.0	14600 6.6	13900 6.3										
L2	147'-8" 45.0	9'-4" - 131'-11" 2.85 - 40.2 m	17600 8.0	17600 8.0	17600 8.0	17600 8.0	17600 8.0	16500 7.5	15700 7.1												
L1	131'-3" 40.0	9'-4" - 131'-3" 2.85 - 40.0 m	17600 8.0	17600 8.0	17600 8.0	17600 8.0	17600 8.0														
ft m	35,300 lbs 16.0 t	4-Part Line max. 35,300 lbs max. 16.0 t																Radius - 2'-7" (- 0.8 m)			
L7	227'-0" 69.2	12'-0" - 48'-7" 3.65 - 14.8 m	21800 9.9	19600 8.9	16100 7.3	13200 6.0	11200 5.1	10400 4.7	9700 4.4	9000 4.1	8600 3.9	7900 3.6	7500 3.4	7100 3.2	6600 3.0	6200 2.8	6000 2.7	5500 2.5	5300 2.4		
L6	210'-8" 64.2	12'-0" - 52'-2" 3.65 - 15.9 m	23800 10.8	21600 9.8	17400 7.9	14600 6.6	12600 5.7	11500 5.2	10800 4.9	9900 4.5	9500 4.3	8800 4.0	8400 3.8	7700 3.5	7500 3.4	6800 3.1	6600 3.0				
L5	194'-3" 59.2	12'-0" - 57'-9" 3.65 - 17.6 m	26900 12.2	24500 11.1	19800 9.0	16800 7.6	14300 6.5	13000 5.9	12300 5.6	11500 5.2	10800 4.9	10100 4.6	9700 4.4	9000 4.1	8600 3.9						
L4	177'-10" 54.2	12'-0" - 61'-0" 3.65 - 18.6 m	28700 13.0	26000 11.8	21200 9.6	17900 8.1	15200 6.9	14100 6.4	13200 6.0	12300 5.6	11700 5.3	10800 4.9	10400 4.7								
L3	161'-5" 49.2	12'-0" - 63'-8" 3.65 - 19.4 m	30200 13.7	27300 12.4	22300 10.1	18700 8.5	16100 7.3	14800 6.7	14100 6.4	12800 5.8	12300 5.6										
L2	145'-0" 44.2	12'-0" - 64'-0" 3.65 - 19.5 m	30400 13.8	27600 12.5	22500 10.2	19000 8.6	16300 7.4	15000 6.8	14100 6.4												
L1	128'-7" 39.2	12'-0" - 66'-3" 3.65 - 20.2 m	31700 14.4	28700 13.0	23600 10.7	19800 9.0	17000 7.7														

Speeds

FU 8-160/4		v = 0 → ~290 fpm (88 m / min.)	10.2 HP 7.5 kW				
SR 10-190/3		v = 0 → ~96 fpm (30 m / min.)	2 x 16.3 HP 2 x 12.0 kW				
K WB 120/4		v = 0 → 0.9 rpm (min ⁻¹)	2 x 11.4 HP 2 x 8.4 kW				
HK max. = 705' (215 m) 6 - layers			480 V / 60 Hz / 3 ph				
Type SR WB 66-80/4F [108 HP] [79 kW]		2-Part Line	Total motor output ~140 HP without SR 10-190/3 ~105 kW Connected power 170 kVA				
		→ 444 fpm 134 m/min		5 500 lbs 2 500 kg	4-Part Line	→ 222 fpm 67 m/min	11 000 lbs 5 000 kg
		→ 276 fpm 84 m/min		9 300 lbs 4 200 kg	→ 138 fpm 42 m/min	18 600 lbs 8 400 kg	
		→ 180 fpm 54 m/min		13 900 lbs 6 300 kg	→ 90 fpm 27 m/min	27 800 lbs 12 600 kg	
		→ 108 fpm 34 m/min	17 600 lbs 8 000 kg	→ 54 fpm 17 m/min	35 300 lbs 16 000 kg		

Counterweight

Jib		L 1	L 2	L 3	L 4	L 5	L 6	L 7
Counterweight	BG	30 000 lbs 13 600 kg	32 200 lbs 14 600 kg	36 600 lbs 16 600 kg	39 150 lbs 17 750 kg	43 550 lbs 19 750 kg	41 350 lbs 18 750 kg	45 750 lbs 20 750 kg
	[lbs]	3 x 6 950 1 x 9 150	2 x 6 950 2 x 9 150	4 x 9 150	3 x 6 950 2 x 9 150	1 x 6 950 4 x 9 150	2 x 6 950 3 x 9 150	5 x 9 150
	[t]	3 x 3.15 1 x 4.15	2 x 3.15 2 x 4.15	4 x 4.15	3 x 3.15 2 x 4.15	1 x 3.15 4 x 4.15	2 x 3.15 3 x 4.15	5 x 4.15



PEINER SK 315 Dimensions and transport weights

See operating manual for mounting weights

	Designation		Dimensions (ft / m)			Weight	Volume	
			l	b	h	lbs / t	ft³ / m³	
1	Jib Section III		39.01	4.99	7.09	4 200	1 386	
			11.94	1.52	2.16	1.92	39.2	
2	Jib Section I		39.01	4.99	5.84	3 790	1 137	
	11.89		1.52	1.78	1.72	32.2		
	Section II		38.65	4.99	6.17	4 320	1 190	
	11.78		1.52	1.88	1.96	33.7		
	Section IV		19.19	4.99	5.41	1 760	519	
	5.85		1.52	1.65	0.80	14.7		
	Section V		35.34	4.99	5.45	3 090	961	
	10.77		1.52	1.66	1.40	27.2		
	Section VI		36.03	4.99	5.48	2 470	985	
	10.98		1.52	1.67	1.12	27.9		
Section VII	33.33	4.99	5.32	1 570	853			
10.16	1.52	1.62	0.71	25.0				
Jib tip X	3.12	5.02	1.64	310	25			
0.95	1.53	0.50	0.14	0.7				
3	Turntable with slewing ring support and cabin		36.35	7.64	7.81	25 350	2 169	
	11.08		2.33	2.38	11.50	61.4		
	Turntable with slewing ring support		31.99	7.64	7.81	24 030	1 911	
9.75	2.33	2.38	10.90	54.1				
Cabin with support and railing	10.17	4.92	7.25	1 320	364			
3.10	1.50	2.21	0.60	10.3				
4	Counter jib with hoist winch		38.13	5.91	6.00	14 550	1 353	
	11.62		1.80	1.83	6.60	38.3		
Hoist winch	66 WB		7.51	5.45	3.28	5 400	134	
2.29	1.66	1.00	2.45	8.4				
5	Counterweight	BG		3.94	1.64	9.32	6 950	60
			1.20	0.50	2.84	3.15	1.4	
			3.94	1.64	12.11	9 150	78	
			1.20	0.50	3.69	4.15	1.7	
6	Tower section	TS 212.1		19.52	7.78	8.01	9 130	1 216
		5.95	2.37	2.45	4.14	34.4		
		TSV 212 with struts	31.17	9.84	10.00	20 330	3 067	
9.50	3.00	3.05	9.22	86.9				
TSK 212	6.63	7.87	9.84	6 170	513			
2.02	2.40	3.00	2.80	14.5				
7	Travelling base, folded	UF 821		41.01	9.74	7.05	35 050	2 816
12.5	2.97	2.15	15.90	79.8				
8	Stationary base, folded	U 821		34.55	9.06	2.79	17 130	873
10.53	2.76	0.85	7.77	24.7				
9	Central ballast block	BZ		11.48	4.92	2.20	11 020	124
3.50	1.50	0.67	5.00	3.5				
10	Foundation pad	BF		9.19	3.28	1.87	8 820	57
2.80	1.00	0.57	4.00	1.6				
11	Accessories					4 800		
						2.17		



Appendix R – Line Painting Schematic

PAVEMENT MARKINGS				
IDENTIFICATION	TYPE	WIDTH	COLOUR	QUANTITY
①	STOP BAR	450 mm	WHITE	N/A
②	CROSSWALK LINE	200 mm x 2	WHITE	N/A
③	SINGLE CENTRELINE	100 mm NOT TO BE PAINTED THROUGH INTERSECTIONS	YELLOW	32.16m
④	DOUBLE CENTRELINE	100 mm x 2 NOT TO BE PAINTED THROUGH INTERSECTIONS	YELLOW	N/A
⑤	SOLID C WITH BROKEN 3x6 LINE	100 mm	YELLOW	N/A
⑥	LANE & BIKE LINES	100 mm	WHITE	N/A
⑦	BROKEN LINE 3x3	100 mm	WHITE	N/A
⑧	BROKEN LINE 3x6	100 mm	WHITE	N/A
⑨	BIKE LANE DASHED LINE 1.5x1.5	100 mm	WHITE	N/A
⑩	HATCH	100 mm LANE LINES WITH 600 mm HATCH LINES, 6.0 m SPACING	YELLOW	N/A
⑪	HATCH	100 mm LANE LINES WITH 600 mm HATCH LINES, 6.0 m SPACING	WHITE	N/A
⑫	ARROW	3/4 TAC SIZE	WHITE	N/A
⑬	RESERVED LANE SYMBOL	3/4 TAC SIZE	WHITE	N/A
⑭	BIKE SYMBOL		WHITE	N/A
⑮	SHARED USE LANE SYMBOL		WHITE	N/A
⑯	ZERBA CROSSWALK	600 mm	WHITE	N/A

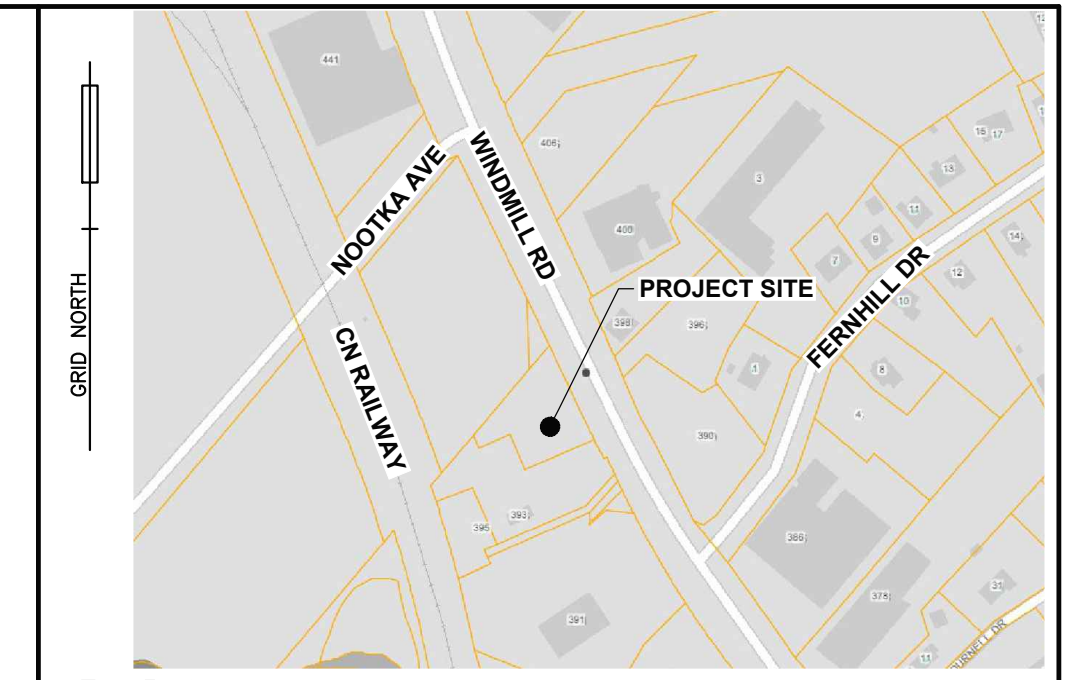

LEGEND		
EXISTING		PROPOSED
25.0	CONTOUR LINE	25.0
⊙/⊙BF	CURB STOP/GATE/BUTTERFLY VALVE	⊙/⊙BF
⊙	FIRE HYDRANT	⊙
⊏	CONCRETE THRUST BLOCK	⊏
⊏	SIAMESE CONNECTION	⊏
⊏/⊏/⊏	CATCH BASIN/PIT	⊏/⊏/⊏
⊏	CULVERT	⊏
⊏/⊏	ROCK LINING/DAM	⊏/⊏
⊏/⊏	ROCK WALL/RETAINING WALL	⊏/⊏
⊏/⊏	POWER POLE & ANCHOR/LIGHT STANDARD	⊏/⊏
⊏	TREE	⊏
⊏	STREET SIGN/PARKING METER	⊏
× 131.82	ELEVATION/GRADE	125.00 × / 4 125.00
⊏	TEST PIT	⊏
⊏	DRAINAGE/SWALE FLOW DIRECTION	⊏
W	WATER MAIN/SERVICE	W
SAN	SANITARY MANHOLE & PIPE	SAN
STM	STORM MANHOLE & PIPE	STM
SAV/STM	COMBINED PIPE	SAV/STM
GAS	GAS LINE	GAS
FL	100YR. FLOOD LIMIT	FL
⊏	GUARD RAIL	⊏
⊏	UNDERGROUND CONDUIT	⊏
⊏	OVERHEAD WIRES	⊏
⊏	PROPERTY LINE/BOUNDARY	⊏
⊏	FENCE	⊏
⊏	BUILDING	⊏
⊏	TOP OF SLOPE	⊏
⊏	TOE OF SLOPE	⊏
⊏	TREELINE	⊏
⊏	LIMITS OF DISTURBANCE	⊏
⊏	TACTILE PEDESTRIAN PLATES	⊏
⊏	PROJECT SAFETY SIGNAGE	⊏
⊏	ORANGE SAWHORSE BARRICADE	⊏

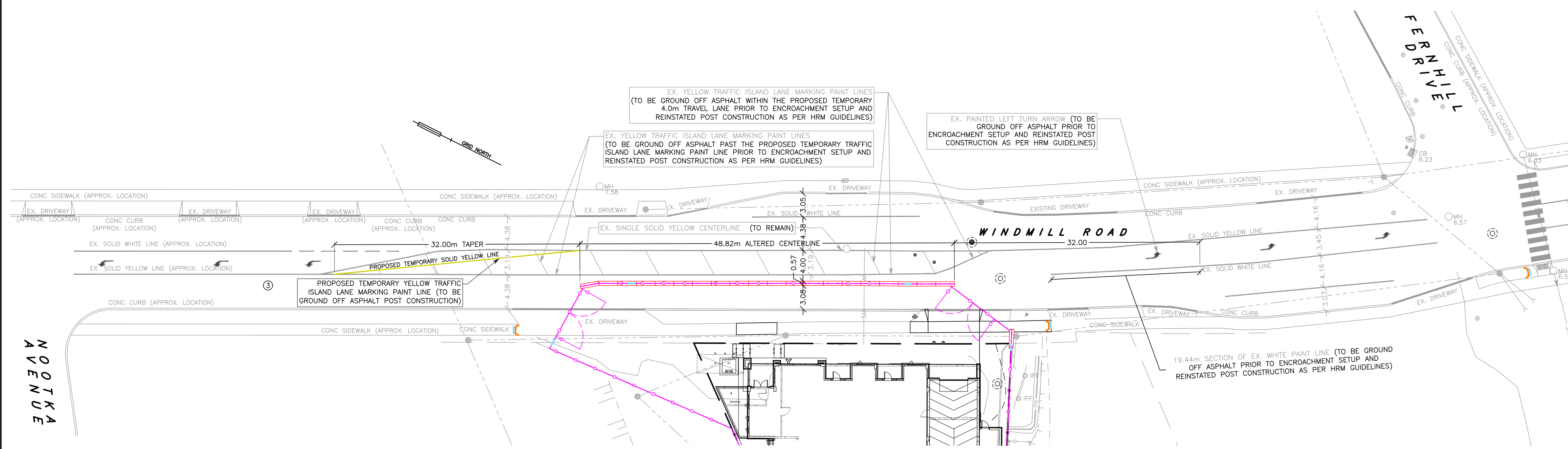

- NOTES**
- THIS PLAN IS IN METRIC.
 - EXISTING CONDITIONS WITH APPROXIMATE LOCATIONS ARE BASED ON GOOGLE AERIAL IMAGERY AS SITE HAS NOT BEEN FIELD SURVEYED; DIMENSIONS MAY VARY AND SHALL BE CONFIRMED BY CONTRACTOR BEFORE PROCEEDING WITH CONSTRUCTION.

APPROVED BY _____ DATE _____

TRAFFIC AUTHORITY _____ DATE _____

FOR THE APPROVAL OF A ALTERED CENTERLINE ONLY. ALL OTHER ASPECTS OF THIS TEMPORARY TRAFFIC CONTROL PLAN MUST FOLLOW THE TEMPORARY CONTROL MANUAL, LATEST EDITION.

1	24/03/15	ISSUED FOR PERMIT	
0	23/02/23	ISSUED FOR REVIEW	
No.	YY/MM/DD	Revision Description	Appr'd

REGISTERED PROFESSIONAL ENGINEER

G.K. MacLean

8978

PROFESSIONAL ENGINEER

NOVA SCOTIA

SDMM

Servant, Dunbrack, McKenzie & MacDonald Ltd.

NOVA SCOTIA LAND SURVEYORS & CONSULTING ENGINEERS

36 QUAND CRESCENT
BENTLEY LAKE BUSINESS PARK
HALIFAX, NS B3S 1G6

PHONE: (902) 455-1537
FAX: (902) 455-9479
WEB: www.sdmm.co

WINDMILL APARTMENT BUILDING
397 WINDMILL ROAD
DARTMOUTH, NOVA SCOTIA

LINE PAINTING SCHEMATIC			
Date	Drawn	Project No.	
FEBRUARY 23, 2023	D. ANDERSON	FILE NO. 1-7-179A (37369)	
Scale	Engineer	Plan No.	
1:300	G. MACLEAN		
Reference	Approved	Drawing Name	
--	G. MACLEAN		
Surveyed	Sheet		
SDMM			R3

