



APPENDIX 2

REGIONAL CENTRE URBAN DESIGN MANUAL

PHOTOGRAPHY CREDITS

River Heim, [Maritime River Photography](#)

TJ Maguire





TABLE OF CONTENTS

| | | |
|------------|---|-----------|
| 1.0 | INTRODUCTION | 5 |
| 2.0 | SITE CONTEXT | 9 |
| | SC1: Community Identities | 10 |
| | SC2: Complete Communities | 12 |
| | SC3: Neighbourhood Character | 14 |
| 2.1 | SITE PLANNING AND DESIGN | 19 |
| | SD1: Active Streetwalls and Prominent Sites | 20 |
| | SD2: Pedestrian-Friendly Mobility Network | 22 |
| | SD3: Open Space Network | 24 |
| | SD4: Pedestrian Comfort | 26 |
| | SD5: Site Impacts | 28 |
| 2.3 | OPEN SPACE DESIGN | 31 |
| | OD1: Neighbourhood Aesthetic Themes | 32 |
| | OD2: Open Space Accessibility | 34 |
| | OD3: Pedestrian Comfort and Interaction | 36 |
| | OD4: Sustainable Landscape Practices | 38 |
| | OD5: Open Space Materials | 40 |
| 2.4 | BUILDING DESIGN | 43 |
| | BD1: Fine-Grained Streetwalls | 44 |
| | BD2: Animated Streetwalls | 46 |
| | BD3: Building Entrances | 48 |
| | BD4: Building Accessibility | 50 |
| | BD5: Building Materials | 52 |
| | BD6: Prominent Sites and Vantage Points | 54 |
| | BD7: Building Impacts | 56 |

1.0 INTRODUCTION

1.1 PURPOSE

The Regional Centre Urban Design Manual (Urban Design Manual) is an Appendix to the Regional Centre Secondary Municipal Planning Strategy (this Plan) and is intended to:

- a. support the Urban Design Goals;
- b. outline additional criteria that must be considered when reviewing certain development agreement proposals; and
- c. encourage design excellence in the Regional Centre through urban design awards.



The Regional Centre

The Regional Centre is the urban core of the Halifax Regional Municipality and generally includes the Halifax Peninsula and Dartmouth within the Circumferential Highway.

This image is not a map, and is not part of the Regional Centre Secondary Municipal Planning Strategy.

1.2 URBAN DESIGN GOALS

The urban design goals are derived from the vision and core concepts of this Plan, public consultation related to urban design in the Regional Centre, and general best practices for urban design.

1.3 URBAN DESIGN CRITERIA

The urban design criteria contained in this manual outline how a project should support the urban design goals of this Plan. Each urban design criteria is supported by a rationale and examples of best practices to ensure the criteria are clear and that the measure of success is well understood. When reviewing applicable development agreement proposals, the urban design criteria that are relevant to the proposal must be reviewed, with the supporting rationale and examples used only when needed for additional explanation and context .

The Urban Design Manual is structured as follows:

- Criterion:** An objective used to evaluate certain development proposals within the Regional Centre.
- Rationale:** An explanation of the criteria (what), the reason the criterion is important for good design (why), and the manner in which success is measured (how).
- Representation:** Pictures and diagrams of the criteria for illustrative purposes only.





2.1 SITE CONTEXT

Site Context is the starting point for successful urban design for a site and informs each section of the Urban Design Manual: Site Context, Site Planning and Design, Open Space Design, and Building Design.

Examples provided in this Urban Design Manual of the successful application of each criterion represent best practices but may not be appropriate for every site. The most appropriate methods can be established through a site and context analysis.

SITE CONTEXT - 1

Criteria 1: The proposed development supports community identities

RATIONALE

What: Community identity describes people's shared or common relationships such as history, backgrounds, knowledge, or preferences. These relationships can be supported through design choices. This is often about the historic function or use of a space and its relationship to current or past users. It is not limited to elements associated with a registered heritage property or cultural landscape, but it may include living heritage such as the traditions, events, objects, and places with significant meaning to one or more communities.

Why: Developments that support community identity reflects and respects past and present community relationships, integrates with existing context, and supports sense of place.



Example 1: Community gathering on Portland Street, Dartmouth.

How: Supporting community identity for a site requires detailed analysis through primary and secondary research methods. Primary research involves the collection of data not previously gathered, rather than the analysis of that which is already available. Secondary research is performed through the summary, collation or synthesis of the results of existing research.

Successful analysis includes documentation of common relationships between the site and associated communities. These efforts acknowledge and carry forward community identity as part of the new development.

Examples of the successful application of this criterion include identifying spaces that support the following:

- past, seasonal, or ongoing events specific to the site or context;
- past or present communities, or persons specific to the site or context;
- heritage resources; and
- cultural artifacts or landmarks.



Example 2: Open spaces are opportunities to reflect and celebrate the history and culture of local communities.



Example 3: Halifax library integrates public art with open space and building design.



Example 4: Community events shape the design and use of open spaces and buildings.

SITE CONTEXT - 2

Criteria 2: The proposed development supports complete communities

RATIONALE

What: Supporting a community is about determining community assets and filling in gaps in housing, services, amenities and activities that enhance how complete a community is for residents or visitors. The meaning of complete community can vary greatly depending on the community's demographic needs and aspirations.

Why: Complete communities are essential to the success and sustainability of the Regional Centre. Identifying gaps in housing, services, amenities, activities, and the needs of a particular community provides opportunities to design development to fill these gaps and ensure each community is more complete and offers social, economic, and environmental quality of life.



Example 1: Hydrostone Market, Halifax.

How: Supporting complete communities requires detailed analysis through primary and secondary research methods. Successful analysis includes documentation of the relationships between communities in an area and supporting services and amenities, or lack thereof. This Plan contains information which describe the relationship between people, services, amenities, and land uses for various areas within the Regional Centre.

Examples of the successful application of this criterion include identifying and supporting the following:

- a variety of shops and services;
- institutional uses (daycares, schools, etc);
- parks and community facilities; and
- a variety of housing choices (multi-unit dwellings, grade-related units, etc.).



Example 2: Complete communities support a variety of housing choices including grade-related units and multi-unit buildings.



Example 3: Nearby institutional uses such as daycares, and park and community facilities such as community gardens support complete communities.



Example 4: Amenities that support access to transit and accessible transportation are important parts of a complete community.

SITE CONTEXT - 3

Criteria 3: The proposed development supports neighbourhood character

RATIONALE

What: Neighbourhood character describes the physical attributes that establish a sense of place at the neighbourhood level. This includes past and existing built and natural environments often evident in architectural styles, massing, siting, materials, and themes. Neighbourhood character is not limited to registered heritage properties or cultural landscapes. Any neighbourhood can support or establish a sense of place through design choices that build upon elements that define the character of the neighbourhood, be they historical or contemporary based on site or context analysis.

Why: Supporting or establishing neighbourhood character can add to the uniqueness of the site and define or perpetuate its sense of place. This form of recognition is important for celebrating the history of the place and providing its residents or visitors with a sense of appreciation, ownership, and inclusion. This can also promote navigation, support a place as a destination or a landmark, and introduce or preserve cultural assets.



Example 1: Agricola Street, Halifax.

How: Supporting the existing neighbourhood character associated with a site requires detailed analysis through primary and secondary research methods. Successful analysis includes documentation of built and natural characteristics of the site, and associated neighbourhood along with determination of which characteristics best support the sense of place.

Examples of the successful application of this criterion include identifying and supporting the following:

- heritage assets and cultural resources;
- natural areas and elements, such as trees or green spaces that complement the network of open spaces;
- built form patterns, such as street layout, sidewalks, pathways, bike routes, transit routes, block structure, massing, and architectural style;
- patterns in the movement of people related to walking and active transportation,
- patterns in material use, colour palettes, and building and site elements,
- physical landmarks, and
- the retention of sensitive environmental open spaces.



Example 2: Physical elements representing historical events support a sense of place.



Example 3: View terminus sites provide opportunities for landmarks and distinct built form elements, Portland Street, Dartmouth.



2.2 SITE PLANNING AND DESIGN

Site Planning and Design is generally concerned with the location and orientation of components or elements of a site, such as building massing, open spaces, land uses, prominent sites, pathways, services, utilities, parking, and driveways.

Criteria contained in the *Site Planning and Design* section are intended to guide site planning and design to result in positive experiences between people and the components or elements of a development site. Thoughtful site planning and design is informed by a contextual analysis and is the foundation for successful open space and building design.



(Photo by Julian Parkinson)

SITE PLANNING AND DESIGN - 1

Criteria 1: The proposed development organizes building massing, open spaces, and uses to create and emphasize active streetwalls and prominent sites

RATIONALE

What: Within the Regional Centre, the predominant orientation and siting patterns of buildings and open spaces includes narrow building lots with massing oriented close to and parallel to streetlines. This pattern establishes streetwalls and building massing that acts to enclose the sidewalk or street, like a wall. Active streetwalls are those that are highly animated with human-scaled elements and active uses. Typically, private open spaces that support active streetwalls are in the form of small front and side yards that emphasize the streetwall. Prominent sites are sites that are part of the built and natural environment that stand out from the urban fabric and act as landmarks. They include view terminus sites, corner sites, and sites that abut significant civic spaces or buildings.

Why: Comfortable, safe, pedestrian-first streets depend on active and animated streetwalls. Organizing massing, open space, and uses to support active and animated streetwalls encourages two-way interaction between buildings, open spaces, and people. People on the sidewalk can window shop, while people in a café or apartment can look out over the streets. In a predominantly residential environment, a desire for privacy can easily compromise an active streetscape, so a balance in this context is needed to achieve both goals. Prominent sites provide greater opportunity to animate streetscapes and create unique places.

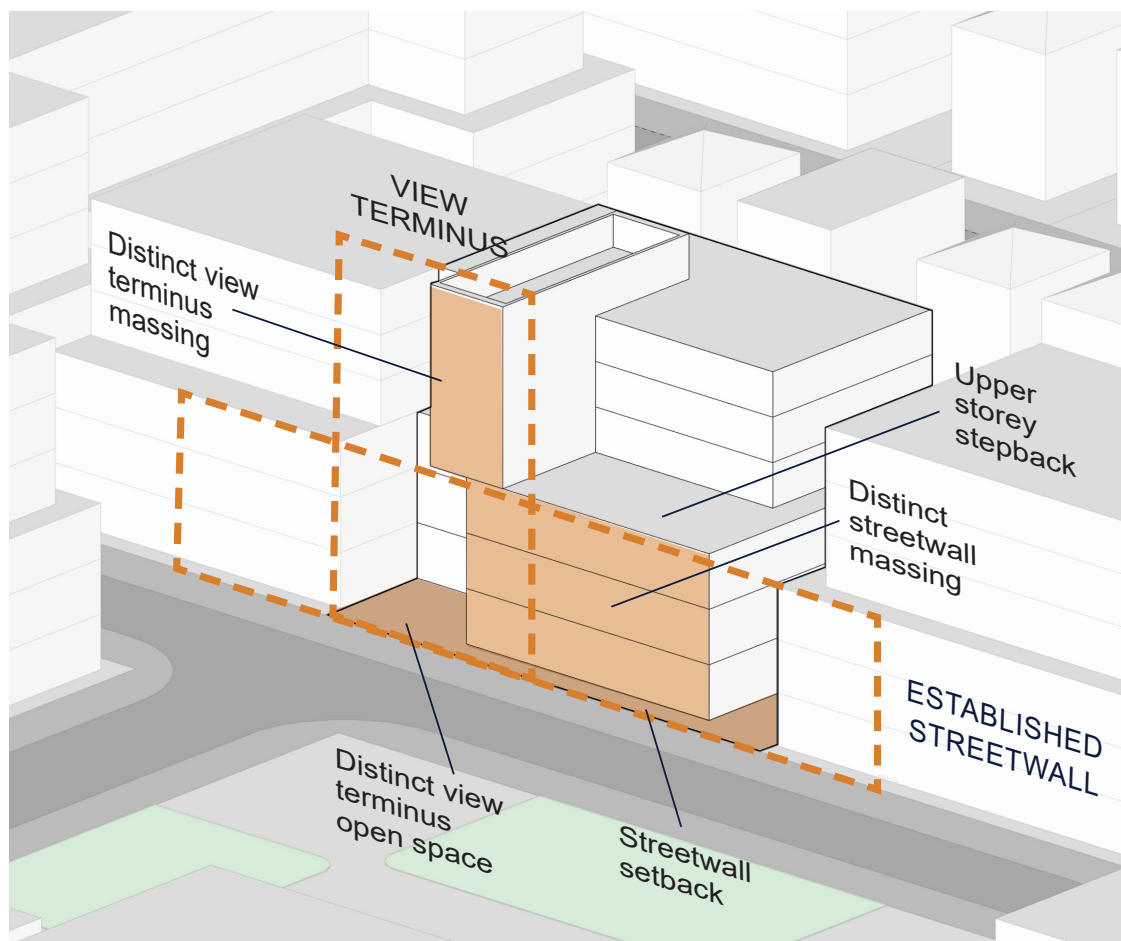

Figure 1: Representation of Site Planning and Design - 1.

How: Where there are clearly established streetwalls located close to the streetline, use abutting buildings and open spaces to inform the siting and orientation of buildings and open spaces.

Examples of the successful application of this criterion include:

- locating buildings at or close to the streetline;
- occupying the majority of any street frontage with a human-scaled streetwall of 2-4 storeys;
- scaling and locating the streetwall consistent with abutting or adjacent heritage buildings;
- emphasizing view terminus sites with an at-grade open space or variations in massing and streetwall height aligning with the view terminus;
- using small open spaces to break up large lots to be consistent with fine-grained street, block, and lot patterns;
- where residential uses are proposed at grade, setting buildings back far enough to provide for privacy, but close enough to the streetline to perceive building details and support an animated streetscape;
- framing all public spaces and private open spaces with a human-scaled streetwall or podium between 2-4 storeys;
- varying streetwall height to emphasize prominent sites;
- where there is a fine-grained context with adjacent or abutting buildings, located close to the streetline, scaling and locating the streetwall consistent with that context;
- in areas where there is a narrow public sidewalk, providing open spaces in the front yard that can act as a small extension of the sidewalk;
- locating the most active uses in a development at-grade and close to the streetline;
- avoiding locating services, utilities, and parking in-line with the terminus line of a view terminus site; and
- minimizing the width of driveways and walkways in front yards to prioritize landscaping and pedestrian oriented architectural features such as entrances and porches.



Example 1: Streetwall established at varying heights with emphasis on the corner, representing the character of Ochterloney Street, Dartmouth.



Example 2: Streetwall established with corner design element reflecting past use of the site.

SITE PLANNING AND DESIGN - 2

Criteria 2: The proposed development retains and introduces connections that support a pedestrian-friendly mobility network

RATIONALE

What: The Regional Centre’s mobility network consists of all the routes that people can take by various means of transportation including walking, cycling, transit, mobility devices, other forms of active transportation, and automobiles. In the Regional Centre, the routes that form this network are structured in a predominant grid pattern of fine-grained, streets and pedestrian connections. These patterns offer multiple route and mobility options, breaking-up large areas with small blocks and frequent intersections.

Why: A highly integrated mobility network of overlapping, fine-grained, linear routes provide a range of beneficial options from which people can choose their preferred route. Ideally, this means encouraging walking and active transportation over automobile use. Large coarse-grained and indirect curvilinear routes reduce mobility options for many individuals and prioritize the use of the automobile over other transportation modes.

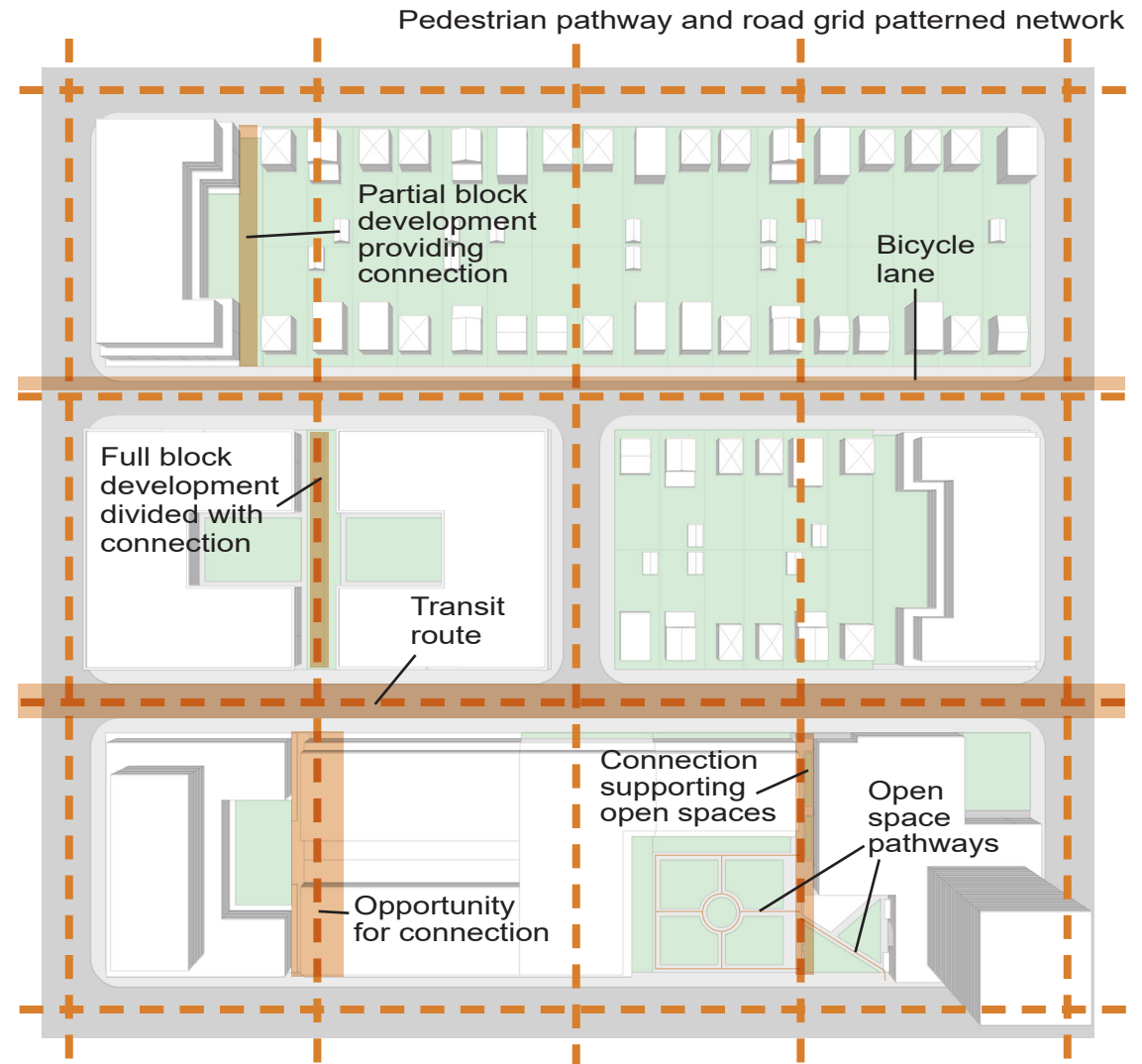

Figure 2: Representation of Site Planning and Design - 2.

How: Where there are clearly established fine-grained mobility routes, use them to inform new routes and connections. Where these do not yet exist, short walkable blocks that consider transit service are encouraged.

Examples of the successful application of this criterion include:

- where there is an existing pedestrian connection or a street that terminates at the site, continuing the connection(s) through the site using open spaces, pedestrian paths, or driveways with sidewalks;
- introducing new pedestrian connections through large sites to support the fine-grained mobility network;
- providing multiple accessible points through open spaces and to buildings;
- locating active uses adjacent to or abutting connections to animate the spaces and support their safe use;
- framing sidewalks with distinct and active human-scaled streetwalls;
- aligning common entrances with transit stops and routes;
- providing connections and spaces for bicycles on site and abutting active transportation routes;
- in areas where there is a narrow sidewalk, providing open spaces in the front yard that can act as a small extension of the sidewalk;
- avoiding cul-de-sacs and curvilinear roads and pathway patterns;
- locating entrances to cycling facilities directly adjacent to the public street or active transportation route and provide wayfinding to external and internal cycling facilities; and
- creating pedestrian-only or shared spaces which serve as areas to work and play.



Example 1: Pathway linking courtyard to sidewalk.



Example 2: Argyle street is a shared street that can be closed to become a pedestrian-only space.

SITE PLANNING AND DESIGN - 3

Criteria 3: The proposed development retains and introduces open spaces that support the existing network of open spaces

RATIONALE

What: The Regional Centre's network of open spaces is a key defining component of the Regional Centre. This network is comprised of and renowned for its wealth of green spaces, tree canopy, historic landscapes and natural areas including: parks, plazas, yards, mid-block open spaces, sidewalks, pathways, boulevards, watercourses and waterfronts.

Why: As a whole, this network plays and fulfills essential ecological, social, and economic roles. In isolation, some spaces may falsely appear to have minimal value and be dispensable. However, it is vital to the success of the Regional Centre and the well-being of its residents, that all new development support the network of open spaces.

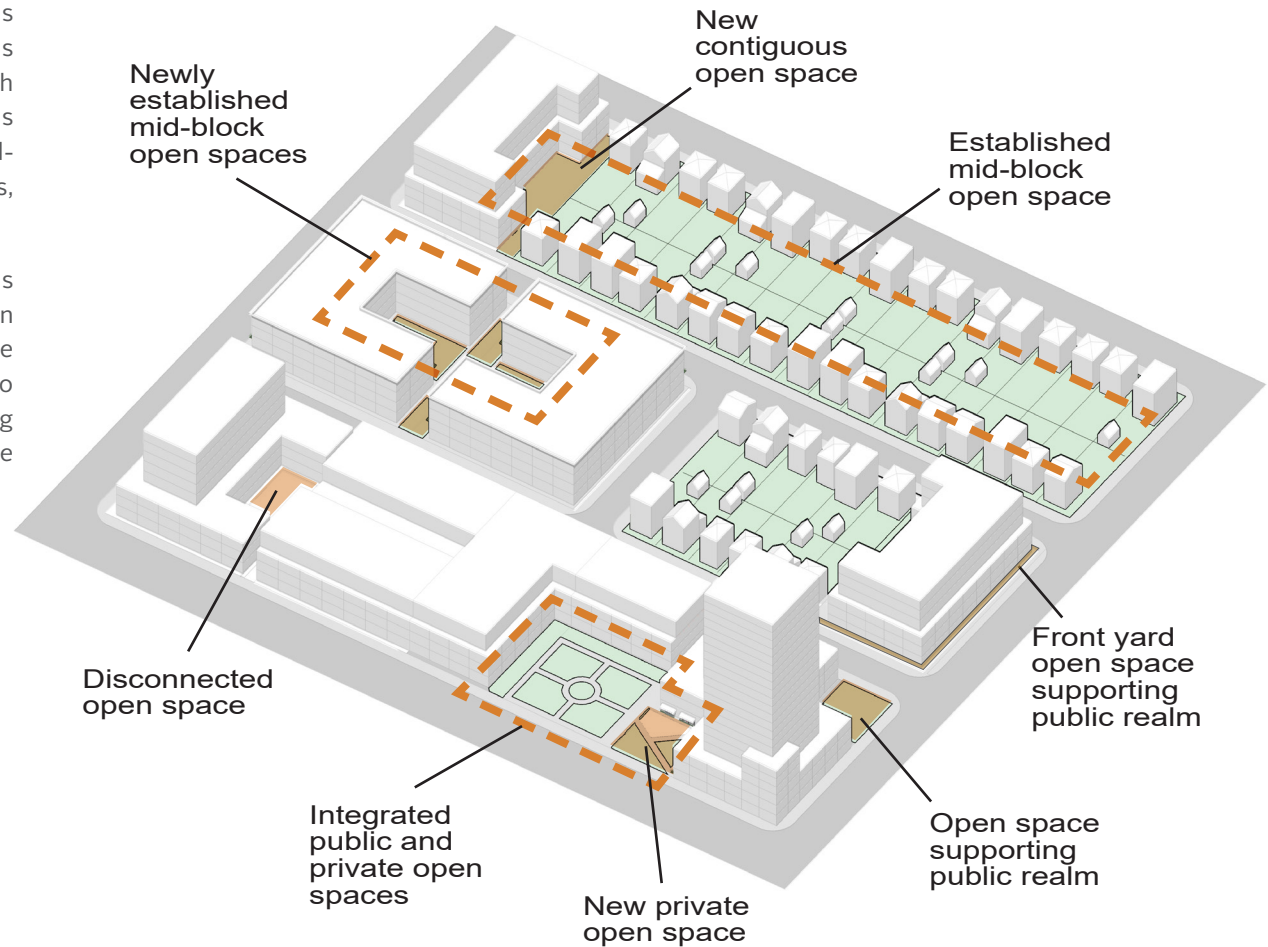

Figure 3: Representation of Site Planning and Design - 3.

How: The siting and design of open spaces and buildings has a significant impact on how well a development supports the open space network, and its vital roles. Every site has an opportunity to support the network of open spaces by introducing new open spaces that integrate with existing spaces, by retaining established open spaces, or minimizing impacts on existing open spaces.

Examples of the successful application of this criterion include:

- physically connecting the proposed open spaces with existing open spaces;
- retaining or introducing mid-block open spaces between residential uses;
- where a clear pattern of front or side yards exist, retaining or introducing the same pattern of yards;
- connecting proposed open spaces with pedestrian pathways and sidewalks;
- framing or enclosing open spaces with human-scaled building massing and elements;
- introducing new open spaces on large sites to expand and support the open space network;
- locating active uses along the edges of open spaces; and
- locating indoor or rooftop amenity spaces to be visually connected to, or overlook existing open spaces.



Example 1: Private open space integrated with public open space and boardwalk.



Example 2: Private open space visually connected to sidewalk reflecting traditional context.

SITE PLANNING AND DESIGN - 4

Criteria 4: The proposed development locates buildings and open spaces to optimize pedestrian comfort related to weather on, abutting, and adjacent to the development

RATIONALE

What: Pedestrian comfort is about how buildings and open spaces are organized on a site, their relationship to each other, and how they can make people more likely to interact with a building or use a space. Weather includes precipitation, heat, cold, shadowing, and wind. For the purposes of this criterion, it also includes general climate conditions.

Why: To be pedestrian friendly and welcoming to a wide range of people, places need to be comfortable in various circumstances and at different times of the year. Where spaces are not designed with weather in mind, they are sometimes rendered impractical or otherwise undesirable for large periods of the year. This compromises pedestrian comfort and goals related to active streetscapes and spaces.

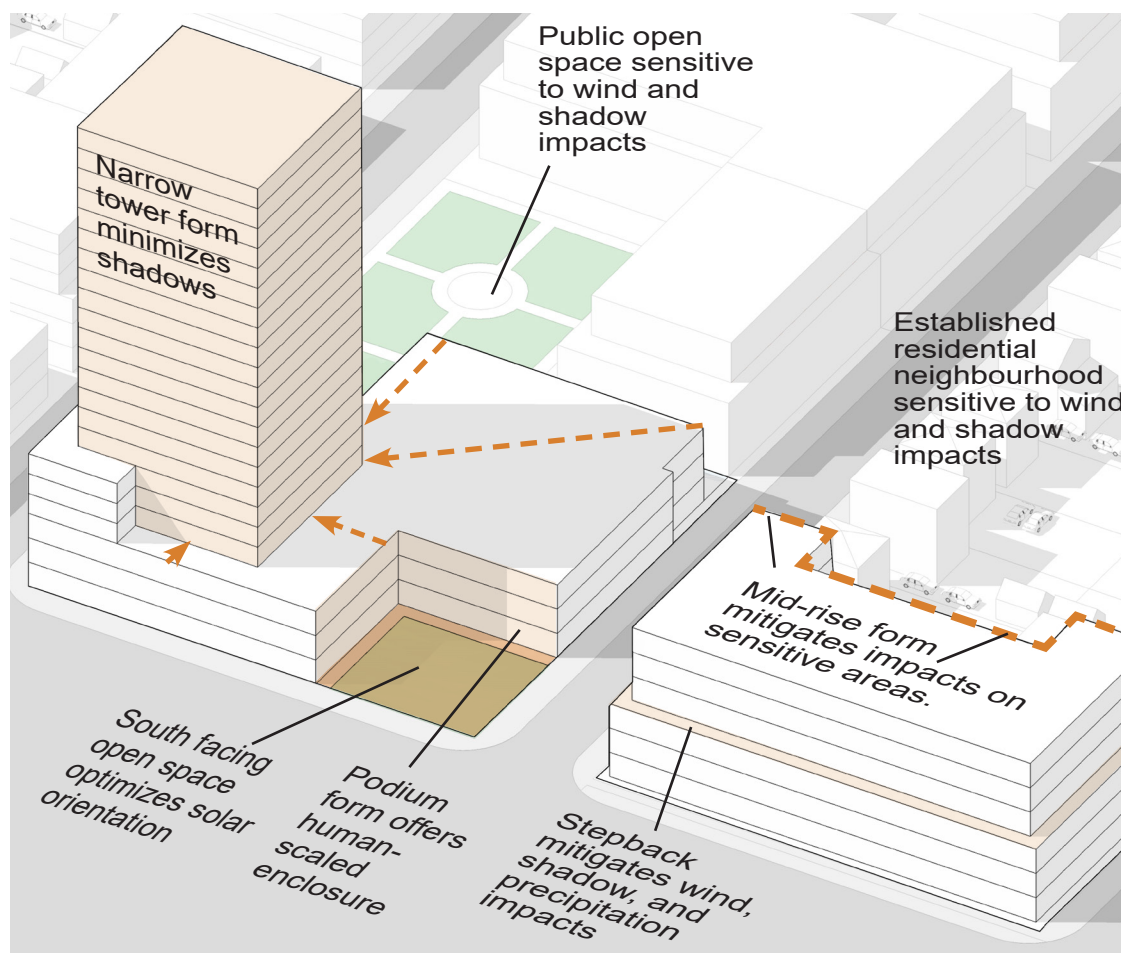
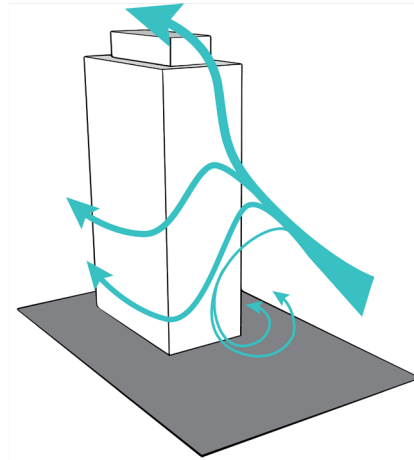

Figure 4: Representation of Site Planning and Design - 4.

How: Active and animated spaces, such as streetwalls and publicly accessible open spaces, are most successful when their design has been informed by optimal solar orientation, wind impact mitigation, and opportunities for protection from precipitation. Generally, mitigating the impact of wind also mitigates negative impacts of precipitation.

Examples of the successful application of this criterion include:

- designing building and locating towers to minimize shadow impacts on abutting open spaces, particularly public open spaces and sidewalks;
- maximizing streetwall stepbacks to mitigate shadow and wind impacts on sidewalks;
- maximizing all stepbacks to upper storeys to mitigate impacts of shadow and wind on residents, the public realm, and abutting residential uses; and
- designing front yards and patios to provide clear access to weather protection directly from the sidewalk.



Example 1: Large sheer walls multiply wind impact.

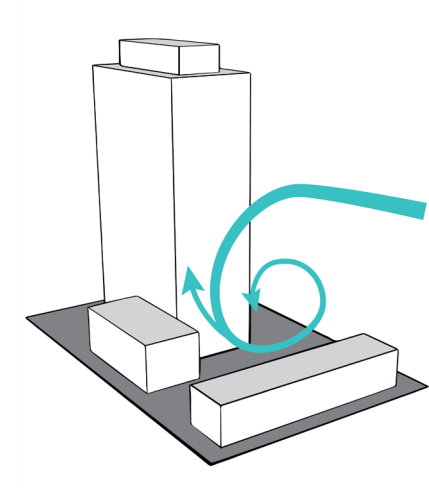

Example 2: Small abutting buildings can mitigate wind impact off site.

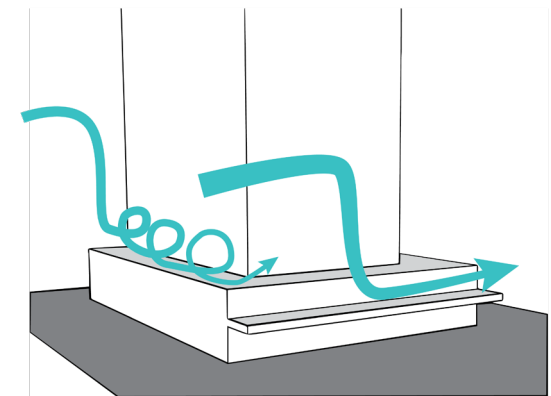
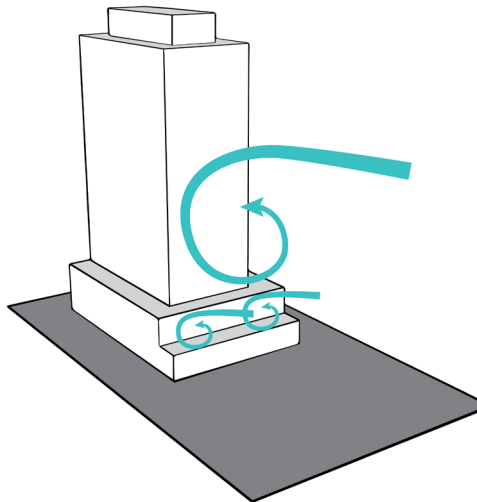

Example 3 and 4: Building stepbacks and projections such as canopies mitigate wind impacts on and off site.

SITE PLANNING AND DESIGN - 5

Criteria 5: The proposed development locates and scales utilities, services, parking, and waste collection areas to mitigate negative impacts on the public realm and neighbouring properties

RATIONALE

What: Most developments require places for utilities, services, and parking. The scale, location, and orientation of these elements typically affect pedestrians negatively.

Why: People will avoid open spaces with high volumes of vehicle traffic, that are unsightly or have bad odours. Back-of-house services are not typically conducive to pedestrian-friendly places. Such open spaces compromise principles and goals related to animation in the streetwall. Yards abutting public spaces and publicly accessible open spaces, are most successful when services, utilities, and parking areas are not a part of the spaces. Where they must be a part of the space, thoughtful design decisions can mitigate their impact on the public realm.

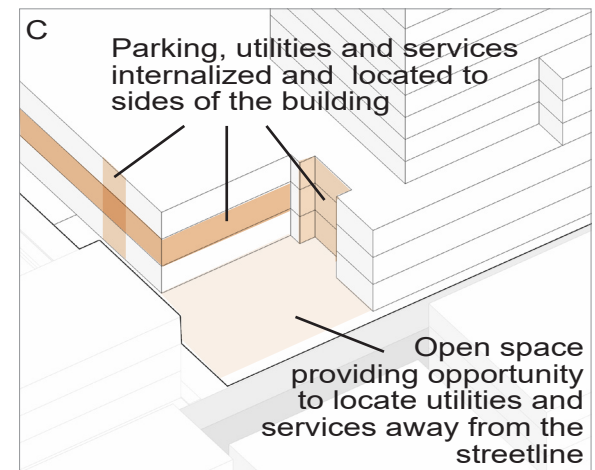
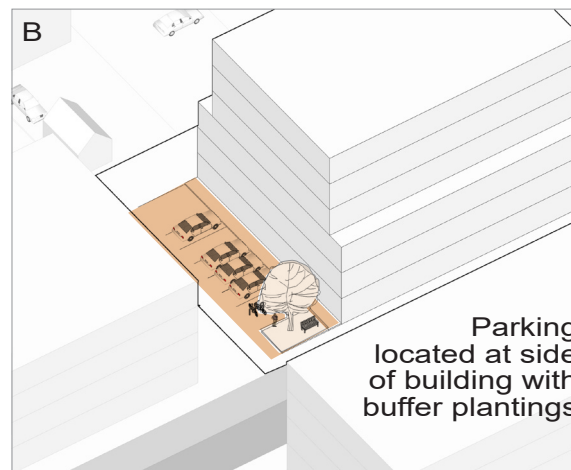
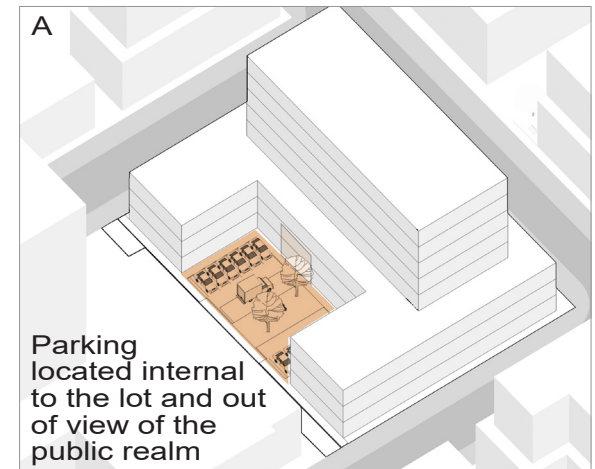
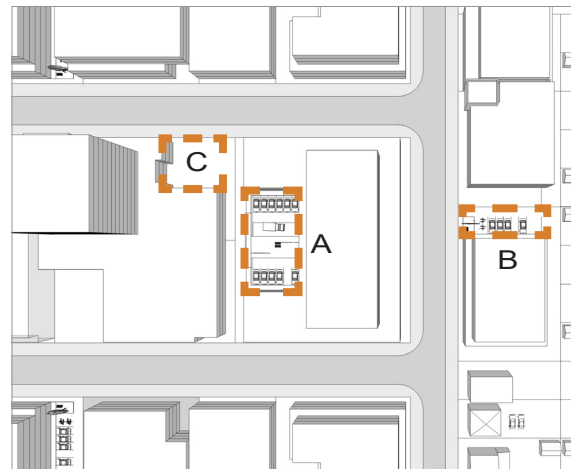

Figure 5: Representation of Site Planning and Design - 5.

How: Integrating utilities, services, and parking into building and open space design, along with buffering techniques, can minimize their impact on the public realm and neighbouring properties.

Examples of the successful application of this criterion include:

- internalizing services, utilities, and parking areas;
- locating services, utilities, and parking areas out of view of the streetline;
- locating access points and parking out of view of the streetline;
- minimizing the scale of utilities; and
- locating utilities and garbage collection areas internal to buildings when possible, and screened from public view with landscaping or enclosures when they must be located externally.



Example 1: Parking located to the rear of a building.

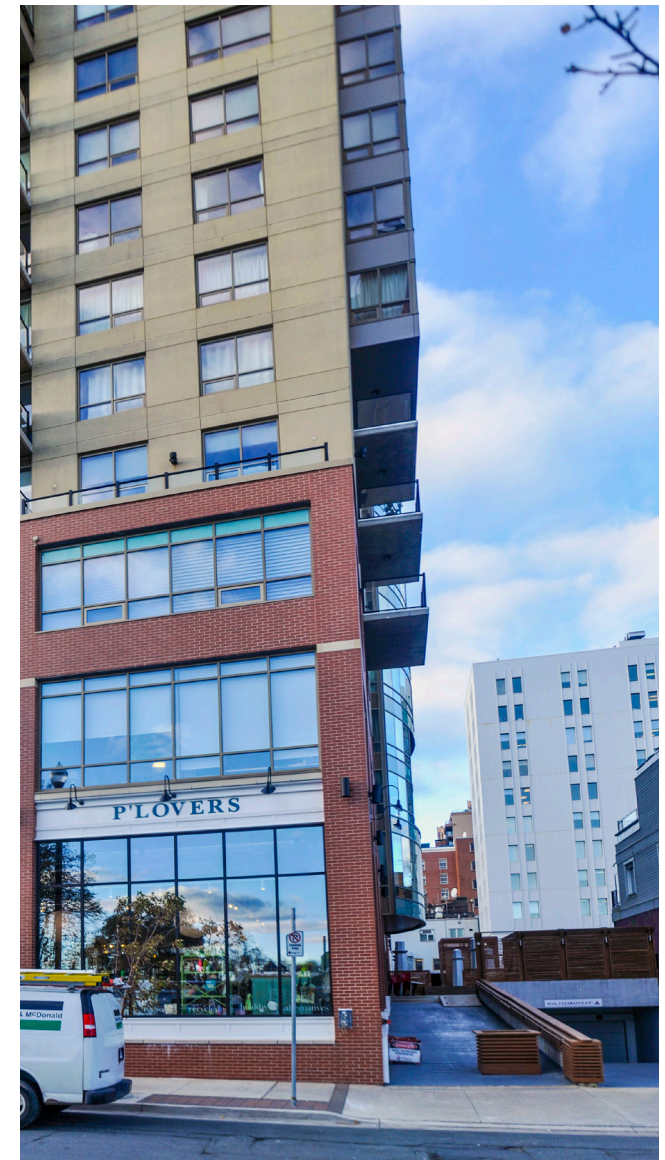

Example 2: Parking entrance located away from the streetwall, to the side of a building.





2.3 OPEN SPACE DESIGN

Open Space Design is generally concerned with the design of spaces that are not occupied by buildings, parking, or driveways. This includes the design and organization of those spaces, such as landscaping, materials, furniture, small structures, weather protection, monuments, and cultural artifacts.

Criteria contained in the *Open Space Design* section are intended to guide the design of open space that provides positive experiences for people and support a pedestrian friendly and human-scaled public realm throughout the Regional Centre.

OPEN SPACE DESIGN - 1

Criteria 1: Open spaces are designed to reflect existing neighbourhood aesthetic themes and enhance the public realm

RATIONALE

What: A neighbourhood theme can be apparent in open space design through the use of materials, plantings, and patterns. An aesthetic theme refers to a collection of such details in an area. This occurs when multiple sites use the same or similar materials and finishing, colours, landscaping and other details, often reflecting a specific era, style, or design intent.

Why: Within the Regional Centre many areas contain distinct or subtle aesthetic themes that contribute to the sense of place for the area. Incorporating elements from a theme into the design of open spaces reinforces the character of an area. Landscaping or open space design that dramatically contrasts a designed or inherent theme, can negatively impact the look, feel, and desirability of the area, and be seen to have a lack of regard for the context.

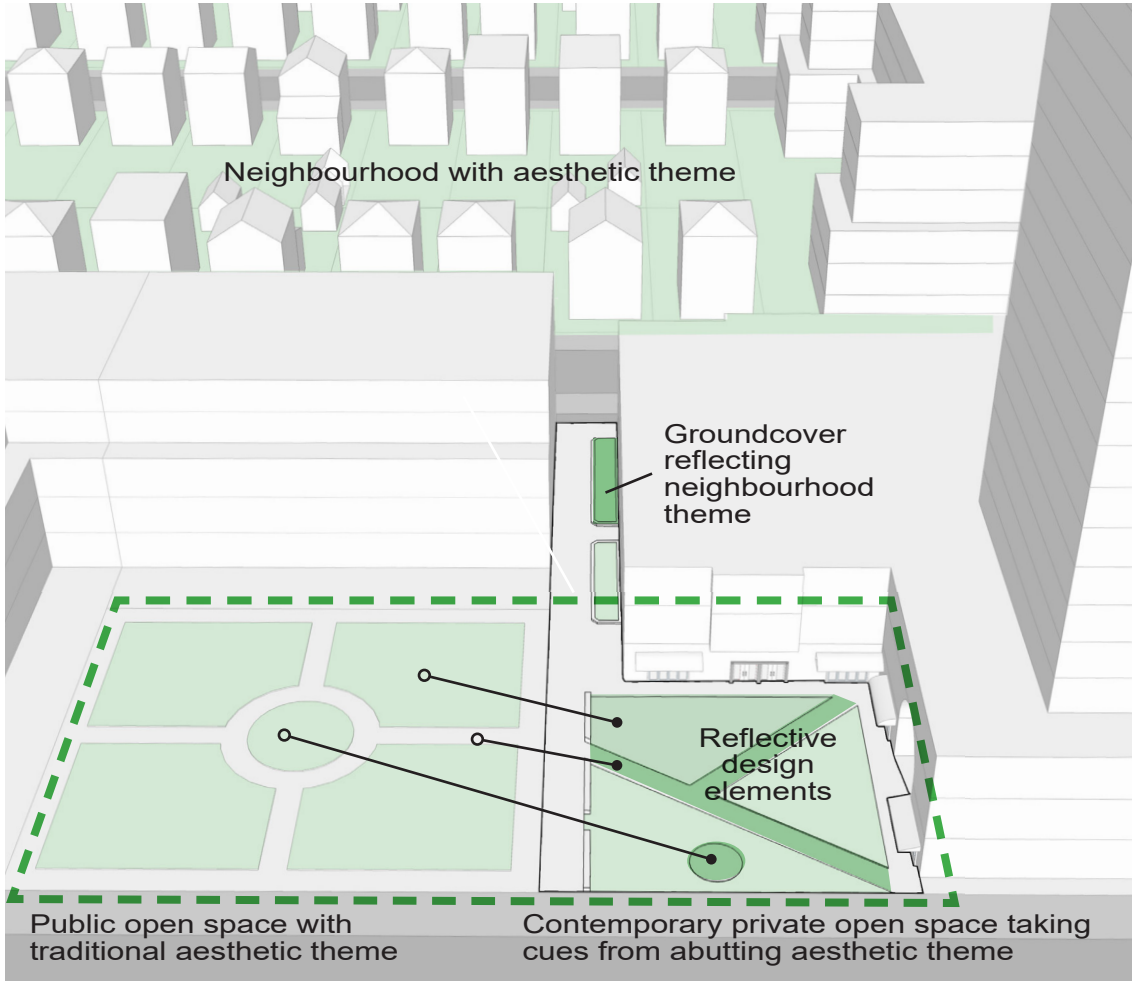

Figure 6: Representation of Open Space Design - 1.

How: Where an area has an existing aesthetic theme(s), successful developments use that context to inform design decisions. Where there is no clear theme, or the theme conflicts with the urban design goals and other policies of this Plan, the design of open spaces should be informed by this Plan and the Land Use By-law.

Examples of the successful application of this criterion include:

- designing all open spaces with material and colour patterns that:
 - are traditionally found within the neighbourhood,
 - reflect or complement abutting public spaces, and
 - reflect or complement abutting heritage assets and cultural resources;
- designing open spaces with plantings and greenery that reflect or complement plantings or greenery on abutting properties;
- designing publicly accessible open spaces with surface materials that link with and expand upon the design of abutting open spaces; and
- using lighting options that complement the site as well as abutting open spaces or building design.



Example 1: Open space and building reflect the historic grainery context. (Photo by Geoffrey Creighton)



Example 2: Open space material and colour patterns in Imagine Spring Garden Road project reflect Spring Garden Road character.

OPEN SPACE DESIGN - 2

Criteria 2: Open spaces used as amenity space are designed to be accessible to all

RATIONALE

What: Designing an open space to be accessible is about design choices that enable pedestrians, including people using mobility devices such as wheelchairs, to easily access and interact with the space. This includes built components of the space as well as other elements that do not specifically relate to physical access.

Why: In the Regional Centre, traditional open spaces have many access issues and are not accessible or receptive to a wide range of people. Some places are hard to access for many people for all or most of the year, particularly in the winter. This is often a reflection of the materials chosen for ground cover and pathways, a lack of accessibility tools or technology, or a lack of appreciation of what it means to be accessible for all ages and abilities.

Welcoming people of all ages and abilities is important because everyone should feel comfortable and free to move throughout their communities and neighbourhoods. This supports complete communities as it pertains to accessing housing, services, amenities, and activities. Open spaces that relegate accessibility infrastructure and segregate any particular group(s), such as ramps away from common entrances, contradict the principles of complete communities.



Example 1: Robert Burns Plaza, Halifax.

How: Successful open space design incorporates accessibility measures and, specifically responds to the needs of the development site's associated communities and neighbourhoods. Open spaces that integrate accessible features are most successful when they complement urban design and do not draw overt attention to any particular mobility challenge.

Examples of the successful application of this criterion include:

- designing open spaces:
 - with clearly defined barrier free access points,
 - with a variety of accessibility tools to help users navigate the space such as signs, tactile strips, audible features, and landmarks,
 - with flat, smooth, and slip-resistant surfaces as to not act as a barrier to any means of mobility,
 - with clearly lit pathways and gathering spaces, and
 - using Crime Prevention Through Environmental Design (CPTED) practices; and
- where there is a narrow sidewalk, designing open spaces in the front yard that act to extend the hard landscaping treatment of the sidewalk.



Example 1: Barrier free open space and amenity on the Halifax Waterfront.



Example 2: Barrier free open space and amenity on the Halifax Commons.

OPEN SPACE DESIGN - 3

Criteria 3: Open spaces used as amenity space are designed to optimize pedestrian comfort and interaction

RATIONALE

What: Pedestrian comfort and interaction are highly dependent on the purpose of the space and designing human-scaled spaces to mitigate the intensity and scale of the surrounding or abutting urban environments, providing respite when needed or desirable. For example, gathering places need relatively large open areas, various seating options, and opportunities for social interaction.

Why: Open spaces designed for pedestrian comfort show concern for both physical comfort from weather, and the social well-being of the users. Various degrees of flexibility are generally desirable for most spaces.

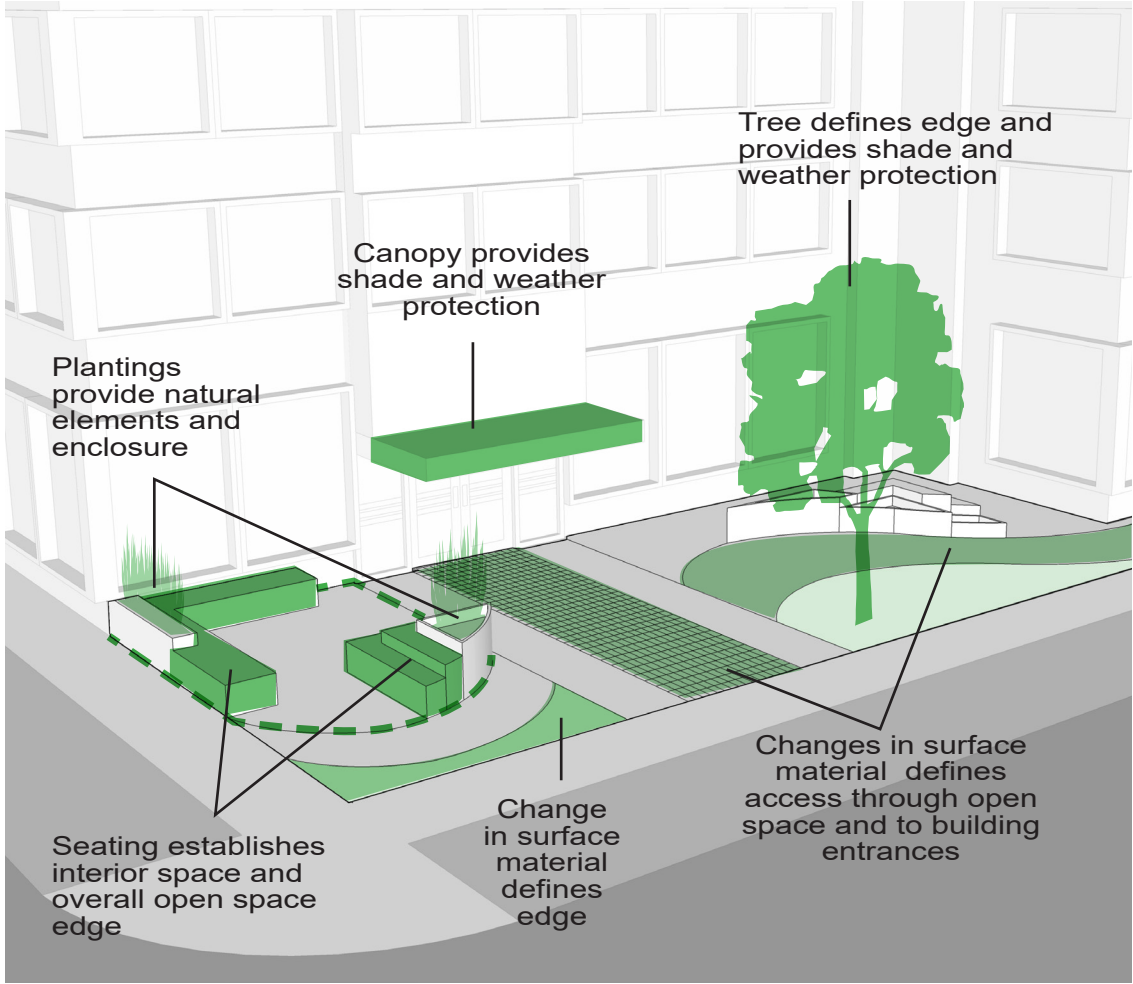

Figure 7: Representation of Open Space Design - 3.

How: Active and animated open spaces, such as streetwalls and publicly accessible open spaces, are most successful when their design has been informed by minimizing shadow, minimizing wind impacts, and providing protection from precipitation. Successful open spaces are designed with the purpose of helping to complete communities in the area. Design can reflect physical and non-physical aspirations.

Examples of the successful application of this criterion include:

- designing open spaces with:
 - trees and a variety of human-scaled elements such as vegetation, planters, chairs, and short stone walls,
 - multiple seating options,
 - pedestrian weather protection from wind, sun and precipitation,
 - design open spaces with interactive elements such as, public art, cultural artifacts, or monuments/ memorial pieces, and
 - multiple access points, well lit pathways, and gathering spaces;
- designing large open spaces with a variety of smaller spaces that reflect different purposes;
- defining the boundaries of open space using treatments such as changes in materials, seating, and plantings;
- integrating abutting facades with canopies and awnings into open space programming;
- maintaining sightlines into open spaces;
- using awnings, canopies, plantings, or moveable furniture;
- avoiding blank walls abutting open spaces;
- integrating the architecture of the building into the open space;
- retaining existing trees which enhance the open space; and
- in areas where there is a narrow sidewalk, designing open spaces in the front yard to extend the same hard landscaping treatment as the sidewalk.



Example 1: Open space with seating options, well defined spaces and weather protection integrated into the existing pedestrian network.



Example 2: Commercial setback containing seating, tables and providing weather protection.

OPEN SPACE DESIGN - 4

Criteria 4: Open spaces are designed to incorporate sustainable landscape practices

RATIONALE

What: Sustainable landscape practices are design solutions that positively impact the environment and raise public awareness of sustainable practices.

Why: Planting native plant species and trees diversifies and strengthens the native vegetation in the region. New innovations in landscaping technology and materials can be used to push creativity in design solutions. A public realm that is designed with regard for sustainable landscape practices is responsive to the environment and actively contributes to the health of the immediate area, its users, and ultimately the Regional Centre.



Example 1: Roof of the Halifax Seaport Farmers Market.

How: Sustainable landscape practices use the benefits of natural systems to:

- manage stormwater capture, infiltration, and water filtration;
- reduce urban heat island effects through different landscaping materials; and
- create habitats for urban wildlife by planting trees and vegetation.

Examples of the successful application of this criterion include:

- using salt-tolerant plant and tree species that can withstand the local environment and climate;
- using native and non-invasive species;
- providing space for gardens for the residents of the development;
- protecting the required landscaping at time of installation;
- using light-coloured and other hard surfaces to manage the urban heat island effect and slow stormwater discharge;
- reducing light pollution with full cut-off light fixtures, automatic shut-off devices and illuminating features with multiple directed lights rather than one broad coverage light;
- using edible plantings, such as fruit trees, to support food security;
- using green walls into the design of open spaces;
- using street furniture constructed from sustainable or recycled materials;
- providing protection for existing natural features and trees; and
- maximizing on-site stormwater capture, infiltration, and reuse through rain gardens, dry-wells, etc.



Example 2: Gardens help support food security and active lifestyles. (Photo by Andi Lo)



Example 3: Soil cells support healthy trees.

OPEN SPACE DESIGN - 5

Criteria 5: Open spaces are designed with durable, high quality materials

RATIONALE

What: Durable, high-quality materials are those that reflect a thoughtful design process and result in permanence and stability. In this regard, a thoughtful design process determines what durability and high-quality means for the site and its context, including climate. Materials include vegetation.

Why: Material selection for open space elements and surfaces can greatly influence the use of the space. Open spaces that offer interesting elements such as trees, places to sit and places to gather, without the benefit of inviting and human-scaled materials, can result in underutilized and unattractive spaces. The exclusive use of hardscaping can be a deterrent for those seeking out natural or naturalized areas, whereas using all softscaping, can be a deterrent for those with mobility challenges or anyone visiting the space following recent precipitation. Materials that are not suited to their context and deteriorate easily generally represent poor design decisions, low quality development, and lack of investment.



Example 1: Open space on Alderney Drive, Dartmouth.

How: Success occurs when open spaces use a range of lasting, quality materials, that can withstand the local environment and climate, and provide multiple attractive and inviting sub spaces. This promotes the full and consistent use of an open space, for all users in different seasons and weather conditions.

Examples of the successful application of this criterion include:

- using materials with a proven track record of durability in the local climate or with evidence that it can withstand the local climate;
- using a range of vegetation adapted to the local environments such as grass and groundcover plantings for softscaping;
- using stone, masonry, or wood as the primary materials for hardscaping and built elements of proposed open spaces;
- using wood or a combination of wood, masonry, and stone for site furniture and related elements;
- avoiding the use of asphalt; and
- avoiding the exclusive use of hard or softscaping materials.



Example 2: Patios and setbacks contain materials requiring minimal maintenance.

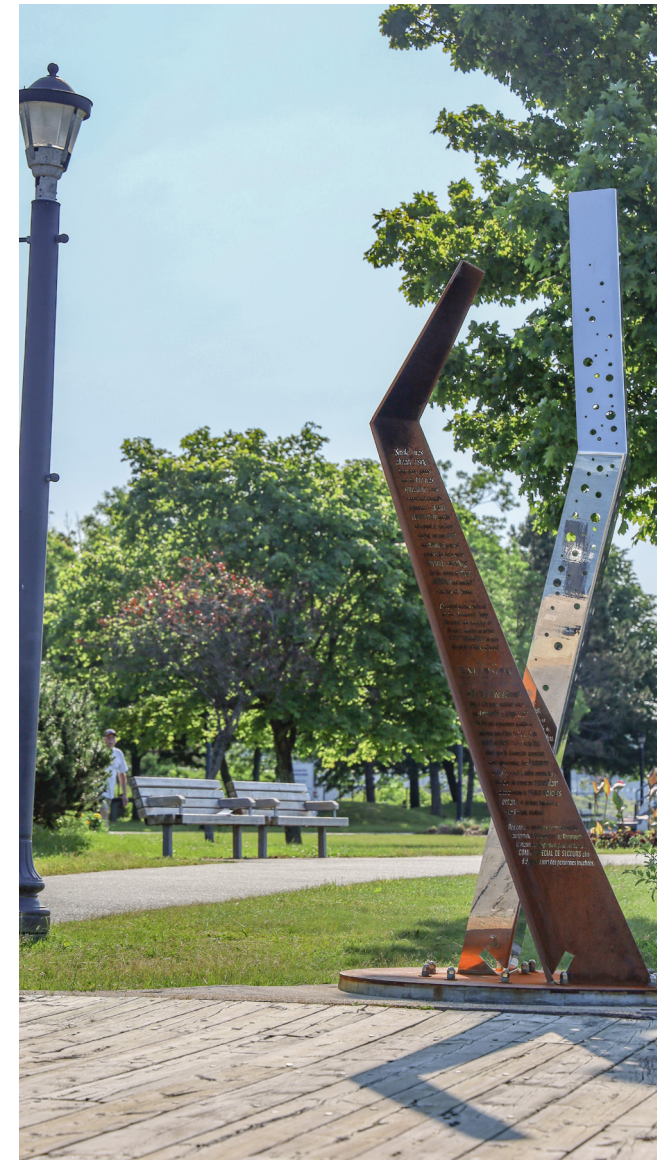

Example 3: Surface materials, public art, lighting, seating and vegetation chosen for durability in harsh climate, and reflect character of context.



HAWAII SEAPORT
FARMERS MARKET

BOOK DROP

BIBLIOTHÈQUES

FISH & CHIPS
CHOWDER
LOBSTER
RISOTTO

2.4 BUILDING DESIGN

Building Design is generally concerned with the design and organization of buildings and accessory structures. This includes the design and organization of the elements of a building such as streetwalls, podiums, the upper storeys, building materials, lighting, signage, parking, services, and utilities.

Criteria contained in the *Building Design* section are intended to guide the design of buildings that provides positive experiences for people and support a pedestrian-friendly and human-scaled public realm throughout the Regional Centre.



BUILDING DESIGN - 1

Criteria 1: Buildings are designed with clearly established streetwalls containing distinct, narrow sections that reflect neighbourhood character and fine-grained lot fabric

RATIONALE

What: The streetwall of a building is the wall or portion of a wall facing a streetline below the height of a specified setback. In stepped buildings, the streetwall is considered the building podium upon which a tower or successive elevations above the streetwall sit or land. The streetwall is below any significantly stepped portions of the façade. In the public realm, it is the most prominent and visible portion of a building.

Why: The two main components of a streetwall that impact pedestrians are height and articulation. The predominant character of the Regional Centre's neighbourhoods is a fine-grained, pedestrian-friendly and human-scaled environment. This supports walkability, encourages a diversity of pedestrian experiences, promotes interactions with buildings, and helps to support complete communities. The fine-grained scale can vary to a limited degree between neighbourhoods, but becomes compromised with large expanses of homogeneous streetwalls, parking, or open spaces. Designing the entire streetwall, including the ground floor, to be fine-grained respects and reinforces the historic built form of fine-grained streetscapes. Establishing a specific streetwall height is important because height is directly linked to human scale and what pedestrians can comfortably observe and enjoy from the sidewalk.

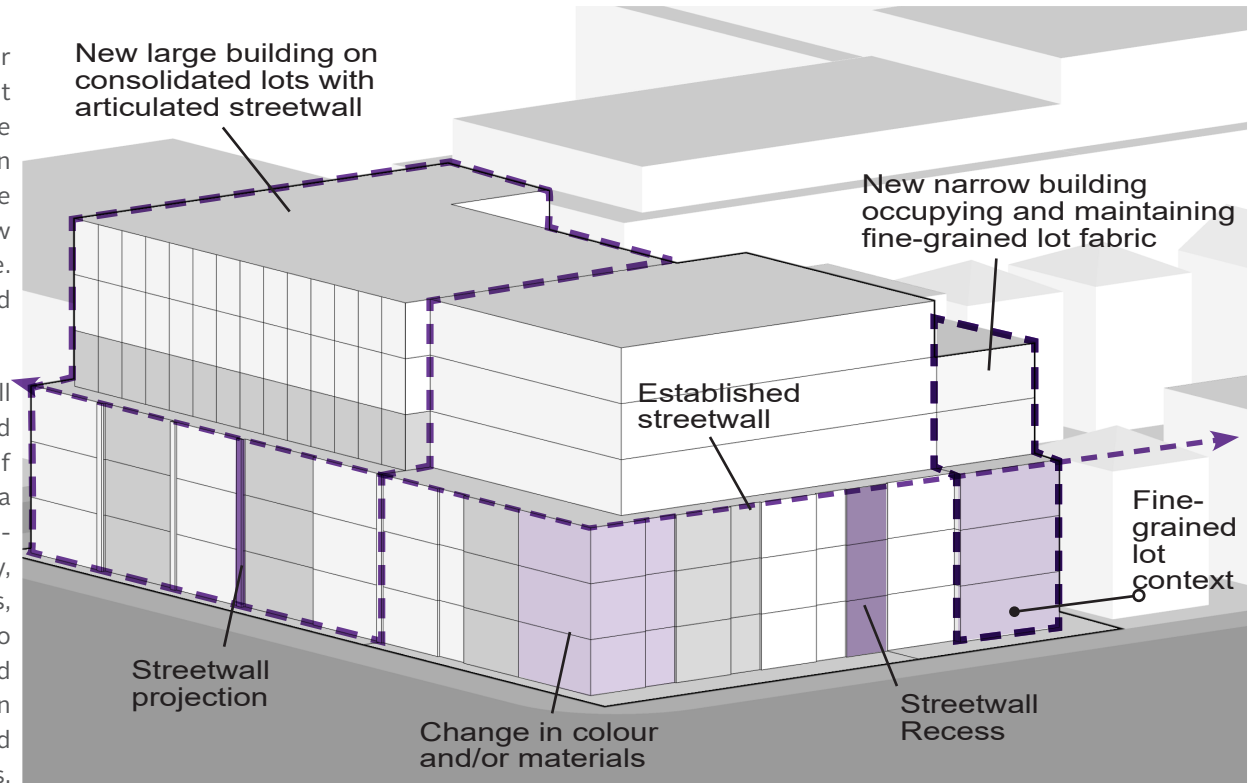

Figure 8: Representation of Building Design - 1.

How: Where neighbourhood character is a fine-grained environment, successful developments use that context to inform design decisions. Success is generally achieved when the entire streetwall is articulated horizontally and vertically with an organized fine-grained rhythm.

Examples of the successful application of this criterion include:

- scaling building footprints to reflect the traditional lot fabric;
- designing buildings that are taller than wide, with narrow frontages;
- using combinations of projections, recesses, changes in materials, and variation in colour to identify distinct sections of the streetwall;
- designing buildings with dimensions that reflect those of abutting heritage buildings and streetscapes;
- retaining existing fine-grained lot fabric;
- minimizing scale of consolidated lots; and
- providing gaps in the streetwall when consistent with a fine-grained neighbourhood character.



Example 1: Narrow building reflecting traditional lot fabric.



Example 2: Large building on consolidated lots with fine-grained streetwall.



Example 3: Narrow building reflecting traditional lot fabric.

BUILDING DESIGN - 2

Criteria 2: Streetwalls are designed with a high level of transparency, and a variety of coordinated human-scaled elements that reflect existing neighbourhood aesthetic themes

RATIONALE

What: Human-scaled elements are the details of a building that reflect the scale of people such as materials, colours, doors, windows, projections, recesses, and other architectural features. Transparent elements are those that allow people to see from the public realm to the interior of a building. An aesthetic theme is a collection of those details coordinated in a specific pattern. Such a theme is easily recognized in a streetwall, when alternate bays or vertical sections of the streetwall, use the same grouping or arrangement of materials, colours and other design techniques. The result can be a design intent that is unique to the building or representative of a specific architectural era, style or other consideration.

Why: Within the Regional Centre many areas have established aesthetic themes that have been preserved and celebrated through diligent upkeep and maintenance. Incorporating elements from an inherent theme into the design of new buildings reinforces the character of an area. Built form that dramatically contrasts a designed or inherent theme, can negatively impact the look or feel of the area.

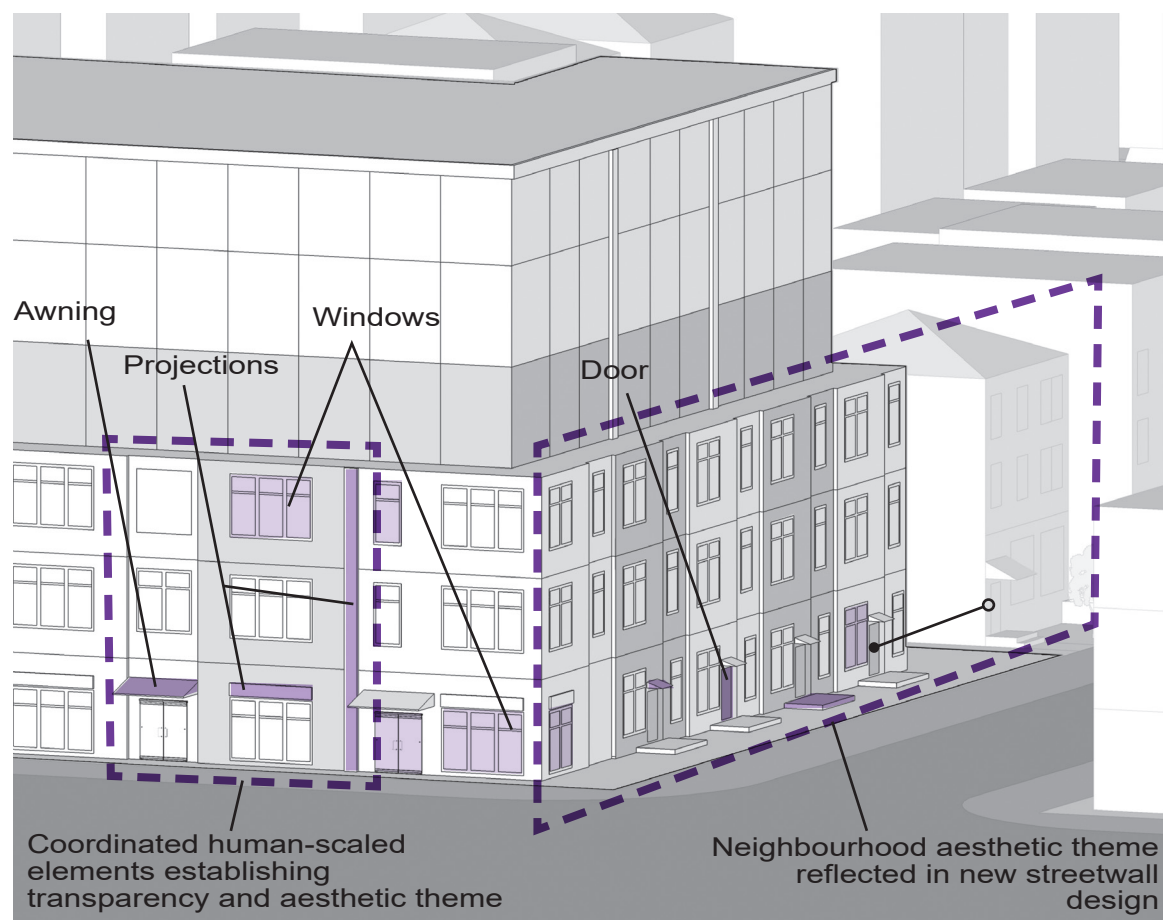

Figure 9: Representation of Building Design - 2.

How: Where an area has a clear aesthetic theme, successful developments are those that use that context to inform design decisions. Where there is no clear aesthetic theme, buildings should be designed as outlined within this Plan, and the Land Use By-law.

Examples of the successful application of this criterion include:

- for each section of the streetwall, providing consistent architectural treatment and materials from grade to the top of the streetwall;
- articulating the vertical and horizontal internal functions of the building through façade elements such as doors and windows;
- where there is a heritage context or a traditional streetwall theme, mirroring those themes;
- using retail bays or grade-related units to articulate streetwalls vertically;
- aligning entrances with each distinct section of the streetwall;
- using operable windows to allow for interaction between building residents and the street;
- continuing the use of high-quality materials around building corners and onto facades fronting open spaces;
- avoiding blank walls, opaque glazing, and long frontages without active entrances;
- avoiding homogeneity of building materials on the ground floor such as curtain wall glazing;
- providing seats, short walls, or other elements that can be used for seating;
- designing porches to be located close to the street to provide opportunities for interaction between residents and pedestrians; and
- emulating established patterns of fenestration, doors and entryways using high quality materials which complement the neighbourhood character, while avoiding imitations.



Example 1: Building reflecting traditional container pier context. (Photo by Julian Parkinson)



Example 2: Large building with streetwall reflecting traditional context through colours materials and architectural style.

BUILDING DESIGN - 3

Criteria 3: Streetwalls are designed with frequent and distinguished entrances

RATIONALE

What: Clearly distinguishable entrances are openings in the streetwall that are designed to stand out as distinct access points to the interior of the building or site. Distinguishable entrances are clearly visible and accessible from the public realm. Frequency of entrances is about providing a diversity of opportunities for pedestrians to interact with uses internal to the building, and access large sites of buildings at multiple points.

Why: Well designed pedestrian entrances are distinct and act as more than simply a point of access. Pedestrian entrances to a building are sometimes designed strictly for functionality with little emphasis on the entrance as a prominent design element. These limited entrances often blend in with the surrounding cladding material and do little to define or emphasize the entrance point. Regardless of sloping conditions or grade, designing a building with frequent, legible, and emphasized pedestrian entrances reinforces fine-grained articulation, creates additional visual interest, enhances walkability, and welcomes people into the building. Clearly identified entrances also help improve wayfinding by allowing first time visitors, emergency responders, and delivery people to quickly and easily locate the building's entrances.

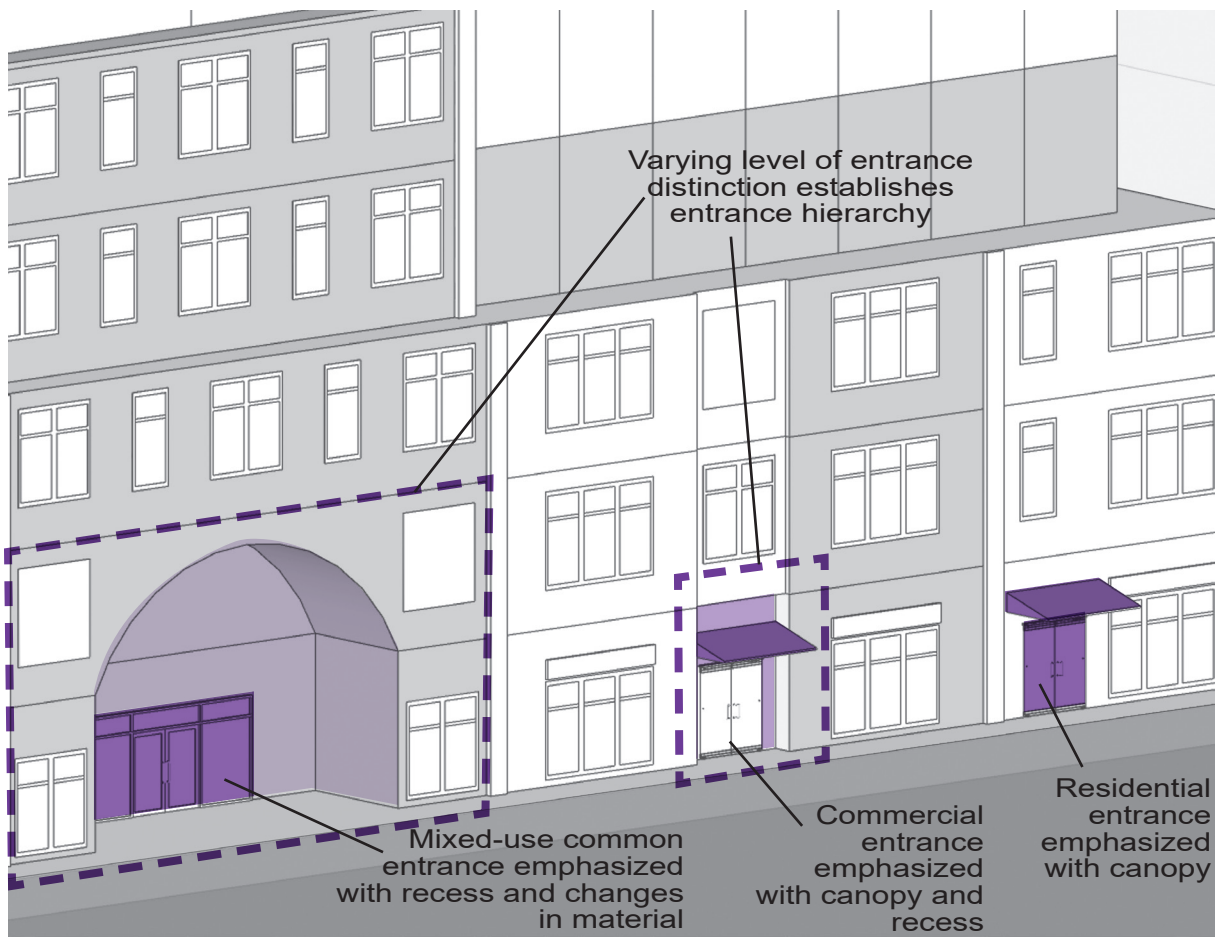
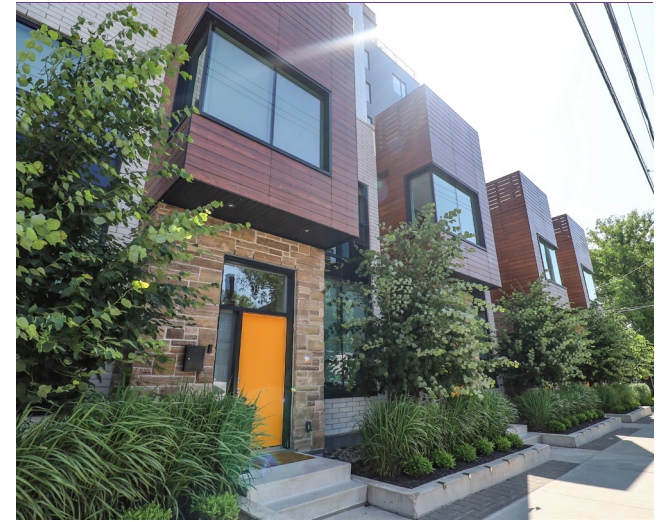

Figure 10: Representation of Building Design - 3.

How: Success is achieved when the frequency and legibility of entrances are directly related to the purpose and scale of the building and site. Successful streetwalls emphasize their internal uses with distinct entrances that differentiate between commercial and residential uses.

Examples of the successful application of this criterion include providing:

- building entrances through one or more of the following expressions: height, width, recesses, canopies, awnings, or landscaping;
- separate canopies or awnings for each building entrance;
- building entrances with breaks in streetwalls, variation in streetwall height and sightlines;
- building entrances that are similar for both sloping and flat conditions;
- clearly distinguishable common entrances in the streetwall to access upper storey uses;
- clear signs to delineate residential entrances;
- distinct building entrances for residential and commercial entrances through architecture and design;
- focused lighting above building entrances;
- unobstructed entrances to the building;
- signs that identify a ground floor business or businesses located on upper storeys, above or adjacent to the entrance;
- making entrances clearly visible from a public street or walkway and accessed by a direct path;
- providing a transition from public to private spaces with landscaping or hardscaping, changes in materials or colours, or the inclusion of porches; and
- highlighting the entrance with architectural details such as transom windows, columns, projections, and decorative or colourful doors.



Example 1: Residential entrances for grade-related units.



Example 2: Large building with common residential entrance and separated commercial entrances.

BUILDING DESIGN - 4

Criteria 4: Buildings are designed to be accessible to all

RATIONALE

What: Access is about the design of buildings, so they may be accessed, and used to the greatest extent possible by all people regardless of their age or ability. It promotes feeling of belonging and allows all individuals to participate in the urban life and vibrancy within and surrounding a building. Designing a building to be accessible is about design choices that enable pedestrians to easily access the building. This includes elements of the building that do not specifically relate to physical access such as signs and audible tools.

Why: Welcoming people of all ages and abilities is important because everyone should feel comfortable and free to move throughout their communities and neighbourhoods. This supports complete communities as it pertains to accessing housing, services, amenities, and activities. Building design that relegates accessibility infrastructure, such as ramps located away from common entrances, and segregates any particular group contradicts the principles of complete communities.



Example 1: Halifax Central Library on Spring Garden Road, Halifax.

How: Successful building design incorporates accessibility measures and, specifically responds to the needs of associated communities and neighbourhoods. Buildings are most successful from an accessibility perspective when they do not compromise general best practice in urban design or, draw overt attention to any particular mobility challenge.

Examples of the successful application of this criterion include providing:

- at-grade entrances for direct access from the sidewalk to building entrances;
- internalized access ramps or, where external ramps are necessary, where possible avoid the access ramps running the length of the façade;
- signs indicating the location of accessible entrances and for wayfinding tools; and
- clearly delineated, safe and accessible pedestrian access routes though accessory surface parking areas.



Example 2: Stepped floor plates respond to grade changes.

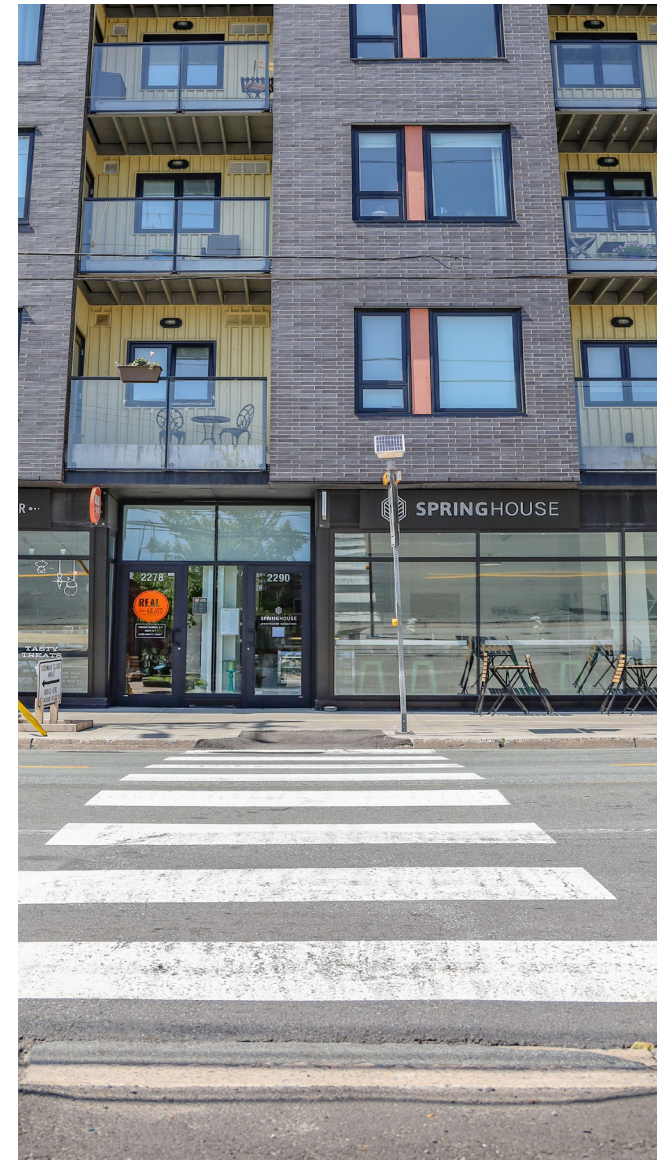

Example 2: Building providing clear at grade accessible entrance.

BUILDING DESIGN - 5

Criteria 5: Buildings are designed with durable, high quality materials

RATIONALE

What: Durable, high-quality materials are those that result in permanence and stability. In this regard, a thoughtful design process determines what durability and high-quality means for the site and its context, including climate.

Why: Material selection for buildings can greatly influence their use and relationship to people and the public realm. Material choices that are of the highest quality and true to their nature, illustrate a lasting investment in the building and a positive relationship with pedestrians and the surrounding context. Materials that are not suited to their context and deteriorate easily, generally represent poor design decisions, and low quality development.



Example 1: Hydrostone historical development, Halifax.

How: Success occurs when buildings use a range of lasting quality materials that present the building as attractive and inviting and require minimal maintenance. This promotes interaction with and use of the building in all different seasons, and weather conditions.

Examples of the successful application of this criterion include use of:

- locally tested and proven high-quality materials on all façades, particularly those that can be seen from the public realm;
- the same durable high-quality materials as those used for abutting heritage resources; and
- masonry, stone, glass, steel, and high-quality natural wood within the streetwall.



Example 2: Balconies reflecting historical context with materials and colour patterns.



Example 3: Streetwall using a diverse range of durable materials that integrate contemporary architecture and historical building practices.

BUILDING DESIGN - 6

Criteria 6: Buildings are designed to emphasize View Terminus Sites and provide visual quality from all vantage points

RATIONALE

What: Visual quality from all vantage points is about ensuring that all building facades that are visible from the public realm positively impact the public perception of a building or neighbourhood. View Terminus Sites are inherently visible from the public realm. View Terminus Sites are emphasized through articulation that focuses attention to all or a portion of the site.

Why: Well-designed buildings, offering coordinated elements, can be easily diminished or appear incomplete if the side of the building does not reflect the high-quality design, materiality, and permeability put into the design of the front. The prominence of a site may be diminished or lost when the building or portions thereof are not differentiated from non-prominent portions of the site and abutting buildings.

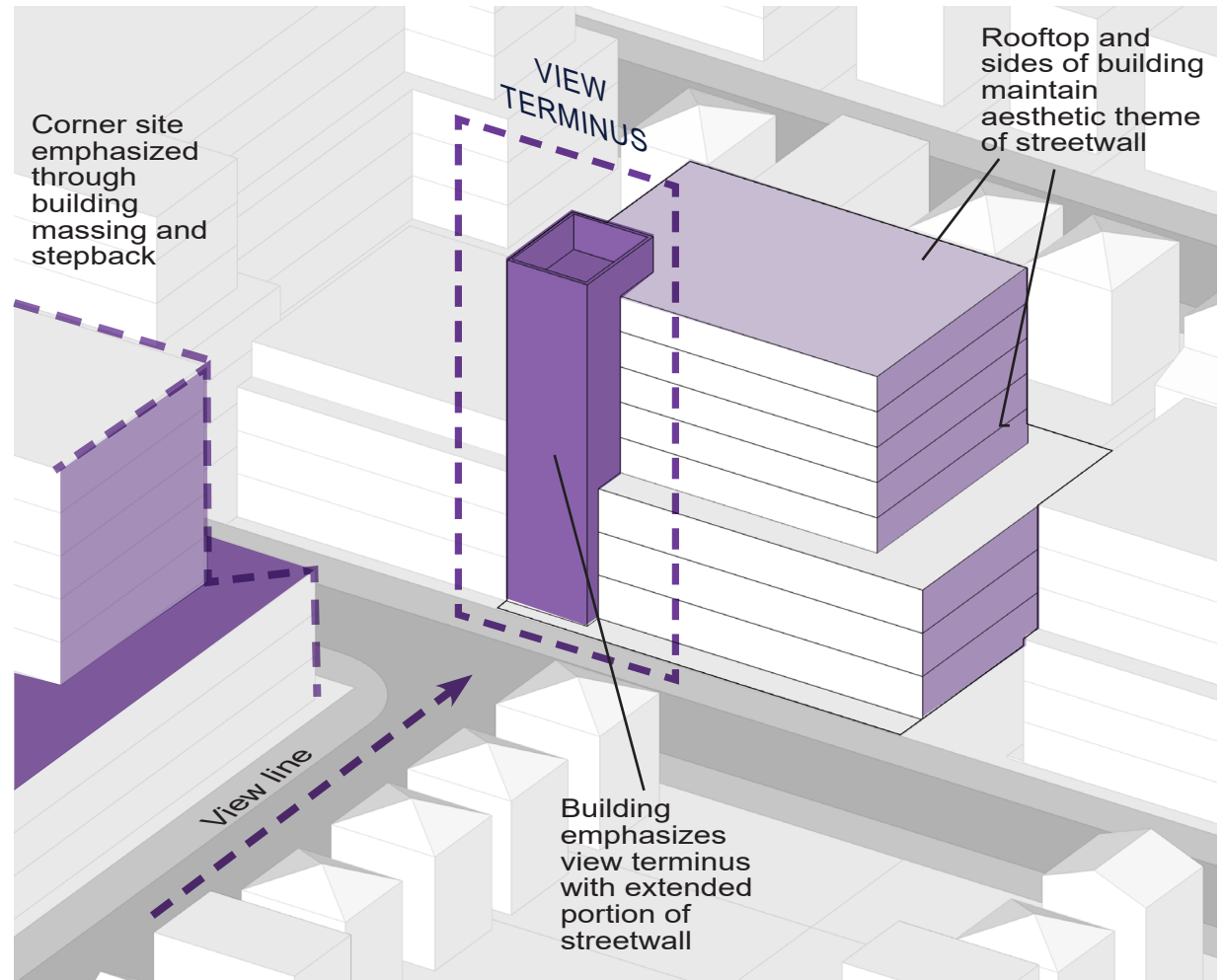

Figure 11: Representation of Building Design - 6.

How: Success occurs when all portions of the podium and upper storeys of a building which can be viewed from the public realm are treated with the same or similar materials, or aesthetic themes are carried throughout the building.

Examples of the successful application of this criterion include:

- avoiding blank walls on all facades;
- using consistent or complementary treatment for all façades;
- integrating rooftop mechanical and telecommunication equipment into the building top, or completely screening such equipment from the street;
- using projections and recesses on portions of the building façade visible from a view terminus line; and
- varying streetwall height to emphasize prominent sites.



Example 1: Streetwall emphasizing corner with building materials and massing.

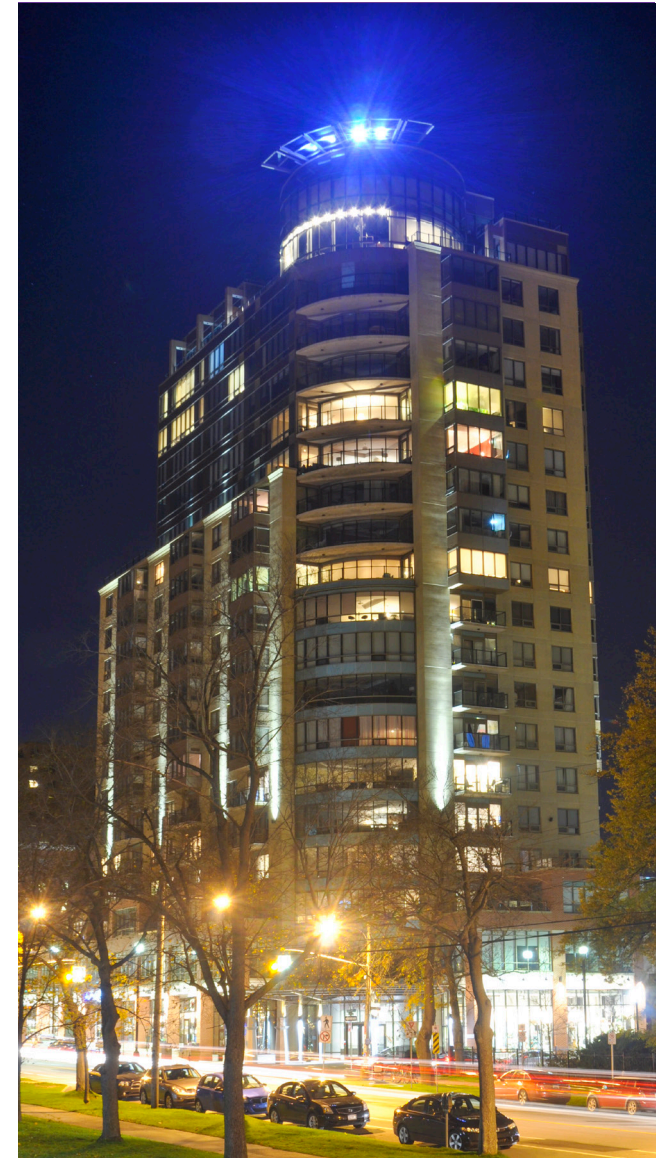

Example 2: Sides and top of building treated with consistent lighting, material and colour patterns.

BUILDING DESIGN - 7

Criteria 7: Buildings are designed with utilities, services and parking to mitigate negative impacts on the public realm and adjacent properties

RATIONALE

What: Most developments require access to spaces for utilities, services, and parking. Although the effects of these elements typically affect pedestrians negatively, design decisions related to the siting, integration, and buffering can minimize their impact.

Why: Buildings can become unwelcoming and inactive where design measures are not taken to minimize the impact of services, utilities, and parking on the public realm. People will avoid places abutting high volumes of vehicle traffic and unsightly or bad smelling places. Back of house services are not typically conducive to pedestrian-friendly places.

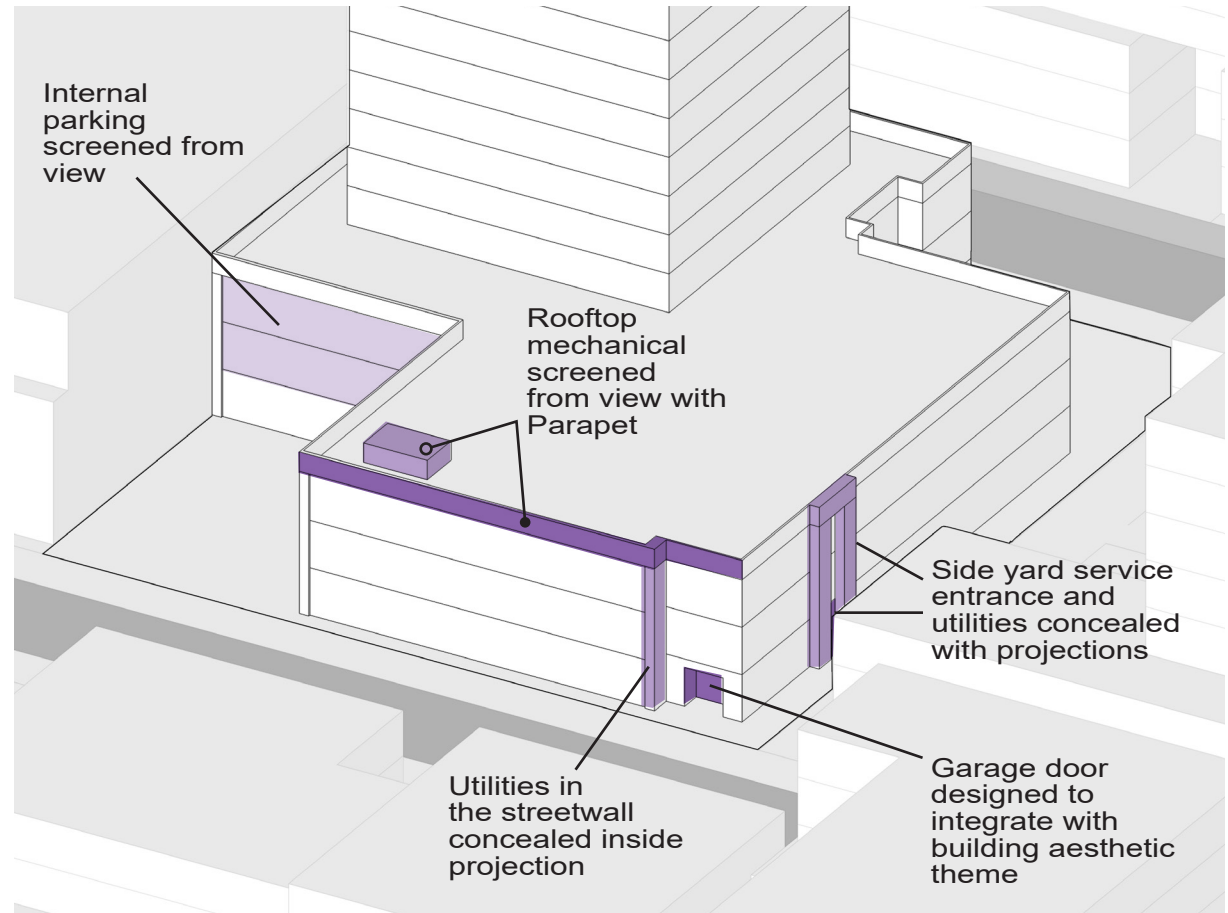

Figure 13: Representation of Building Design - 8.

How: Active and animated spaces, such as streetwalls and publicly accessible open spaces, are most successful when back of house uses are in fact in the back, on the side of a building, or where access points are integrated into the theme of the building design, or architectural concept.

Examples of the successful application of this criterion include:

- locating parking away from the streetline, either underground, inside, or to the rear of the building with access doors not visible from the public realm;
- concealing utilities and services;
- integrating utilities into the building design;
- prioritizing architecture and design strategies to minimize the impact of utilities, with landscape screening used as a last resort;
- consolidating utility rooms and their venting to minimize the impact on façades;
- consolidating garage entrances and service accesses to minimize impact on the street;
- using windows or translucent materials in garage doors to make pedestrians aware of exiting traffic;
- designing garage door widths in keeping with the fine-grained architectural rhythm and articulation of the building; and
- avoiding elements or techniques that detract from adjacent or abutting streetwalls and the associated overall pedestrian experience.



Example 1: Garage entrance integrated with design of building.



Example 2: Underground parking vents integrated into building and open space design.