



P.O. Box 1749
Halifax, Nova Scotia
B3J 3A5 Canada

Item No. 14.4.1
Halifax Regional Council
February 13, 2018

TO: Mayor Savage and Members of Halifax Regional Council

SUBMITTED BY: Original Signed

Councillor Lorelei Nicoll, Vice-Chair, Transportation Standing Committee

DATE: February 2, 2018

SUBJECT: Transit Priority Corridors: Bayers Road

ORIGIN

February 1, 2018 special meeting of the Transportation Standing Committee, Item No. 4.2.

LEGISLATIVE AUTHORITY

Administrative Order 1, Respecting the Procedures of the Council, Schedule 7, Transportation Standing Committee Terms of Reference, section 4 (d):

Duties and Responsibilities

4. The Transportation Standing Committee shall oversee and review of the Municipality's Regional Transportation Plans and initiatives, as follows: providing input and review of the Transportation Road network strategies and related Regional initiatives.

RECOMMENDATION

The Transportation Standing Committee recommends that Halifax Regional Council proceed with detailed design of dedicated bus lanes in both directions on the Bayers Road corridor, including reconfiguration of the Halifax Shopping Centre intersection.

BACKGROUND

A staff report dated January 25, 2018 pertaining to Transit Priority Corridors for Gottingen Street and Bayers Road was before the Transportation Standing Committee for consideration at its special meeting held on February 1, 2018.

For further information, please refer to the attached staff report dated January 25, 2018.

DISCUSSION

The Transportation Standing Committee deferred consideration of the proposed Gottingen Street Transit Priority Corridor (recommendation one of the attached staff report dated January 25, 2018) to its regularly scheduled February 22, 2018 meeting.

Staff provided a presentation with respect to the Bayers Road Transit Priority Corridor and responded to questions of clarification from members of the Standing Committee. The Transportation Standing Committee forwarded the recommendation to Halifax Regional Council as outlined in this report.

FINANCIAL IMPLICATIONS

As outlined in the attached staff report dated January 25, 2018.

RISK CONSIDERATION

As outlined in the attached staff report dated January 25, 2018.

COMMUNITY ENGAGEMENT

The Transportation Standing Committee meetings are open to public attendance, a live webcast is provided of the meeting, and members of the public are invited to address the Committee for up to five minutes at the end of each meeting during the Public Participation portion of the meeting. The agenda, reports, video, and minutes of the Transportation Standing Committee are posted on Halifax.ca.

ENVIRONMENTAL IMPLICATIONS

As outlined in the attached staff report dated January 25, 2018.

ALTERNATIVES

The Transportation Standing Committee did not discuss alternative recommendations.

ATTACHMENTS

1. Staff report dated January 25, 2018.

A copy of this report can be obtained online at halifax.ca or by contacting the Office of the Municipal Clerk at 902.490.4210.

Report Prepared by: Liam MacSween, Legislative Assistant, 902.490.6521



P.O. Box 1749
Halifax, Nova Scotia
B3J 3A5 Canada

Attachment 1
Transportation Standing Committee
February 1, 2018

TO: Chair and Members of Transportation Standing Committee

ORIGINAL SIGNED

SUBMITTED BY:

Kelly Denty, Acting Director: Planning & Development

ORIGINAL SIGNED

Dave Reage, Director: Halifax Transit

DATE: January 25, 2018

SUBJECT: Transit Priority Corridors: Gottingen Street / Bayers Road

ORIGIN

- The Halifax Transit *Moving Forward Together Plan*, approved by Regional Council in April 2016, identified Bayers Road and Gottingen Street as critical choke points for transit service into and out of downtown Halifax that require transit priority.
- At the June 21, 2016 meeting of Regional Council, staff were directed to submit 16 proposed transit projects for cost-shared funding approval under the Public Transit Infrastructure Fund (PTIF). One of those projects proposed was the Transit Priority Corridors project.
- At the February 21, 2017 meeting of Regional Council, Halifax Regional Council authorized the Mayor and Municipal Clerk to sign the fifteen Contribution Agreements with the Minister of Municipal Affairs, to receive funding for public transit projects approved under the Public Transit Infrastructure Fund (PTIF), including one for the Transit Priority Corridors project.
- In May 2017, RFP 17-303 was awarded to WSP Canada Inc. to prepare functional designs for 'Transit Priority Corridors' on Bayers Road (Romans Avenue to Windsor Street) and Gottingen Street (North Street to Cogswell Street).
- At the December 5th, 2017 meeting of Regional Council, the Integrated Mobility Plan was approved, and staff were directed to include an implementation plan in the upcoming staff report for the Bayers Road and Gottingen Street Transit Priority corridors functional design to allow Council to consider construction in fiscal 2019/20.

LEGISLATIVE AUTHORITY

Transportation Standing Committee Terms of Reference, section 4 (a) which states: "The Transportation Standing Committee shall oversee and review the Municipality's Regional Transportation Plans and initiatives, as follows: overseeing HRM's Regional Transportation Objectives and Transportation outcome Areas".

Halifax Regional Municipality Charter, subsection 318(2): “In so far as is consistent with their use by the public, the Council has full control over the streets in the Municipality.”

Halifax Regional Municipality Charter, subsection 322(1): “The Council may design, lay out, open, expand, construct, maintain, improve, alter, repair, light, water, clean, and clear streets in the Municipality.”

RECOMMENDATION

It is recommended that the Transportation Standing Committee recommend that Halifax Regional Council:

1. Proceed with detailed design of a dedicated northbound bus lane on the Gottingen Street corridor, including a Parking Loss Mitigation Plan which includes engagement with the public and stakeholders, and return to Council with a recommendation prior to tendering the project.
2. Proceed with detailed design of dedicated bus lanes in both directions on the Bayers Road corridor, including reconfiguration of the Halifax Shopping Centre intersection.

EXECUTIVE SUMMARY

The Halifax Transit *Moving Forward Together Plan* (MFTP), approved by Regional Council in April 2016, identifies Bayers Road and Gottingen Street as critical choke points for transit service that require transit priority. To improve transit service on these corridors, the MFTP recommends investment in transit priority measures (TPMs) that provide priority to the movement of buses over general traffic. These recommendations have been further reinforced by policy direction in the recently adopted *Integrated Mobility Plan* (IMP). When the IMP was adopted in December 2017, Regional Council also directed staff to include an implementation plan for Bayers Road and Gottingen Street so that Council could consider construction in fiscal 2019/20.

The physical characteristics of the corridors, as well as how people use them, have a major influence on the type of transit priority measures that can be implemented. Also, as is typical with any project that involves reconfiguration of an existing street, there are trade-offs that need to be considered. Where right-of-way expansion is necessary, there may be impacts to utilities, private property, and other infrastructure. Loss of traffic lanes and curb access used for on-street parking, loading, and stopping may also be necessary. These impacts are consistent with the IMP, which notes that parking management should be aligned with the goal of shifting more trips to active transportation, transit and car-sharing, while supporting growth in the Regional Centre. Effectively managing the supply of parking can help to influence travel habits and improved parking efficiency can reduce the amount of space needed for parking. As an initial phase of detailed design, a Parking Loss Mitigation Plan will be carried out in consultation with local Gottingen Street businesses to help ensure that adequate short-duration parking is provided for this important commercial area.

Following approval of the MFTP and securement of funding support from the Public Transit Infrastructure Fund (PTIF), a consultant was retained in May 2017 to complete a functional design study for transit priority corridors on Bayers Road and Gottingen Street. Multiple design options were completed for each corridor, representing a range of investment scenarios. The design options were evaluated based on various criteria that considered the potential to improve transit operation, multimodal impacts (walking, bicycling, traffic), curbside impacts (parking, loading), implementation cost, and the feedback received from stakeholders and the public. Analysis was also completed to relate capital / operational costs to operational benefits and develop an understanding of the cost-effectiveness of each option.

Based on the findings of the functional design study, this report recommends that both the Bayers Road and Gottingen Street transit priority corridors be advanced to the detailed design stage. The recommended configuration for Gottingen Street includes a continuous northbound transit lane between Cogswell Street and North Street. The recommended configuration for Bayers Road includes continuous dedicated transit

lanes in both directions between Romans Avenue and Windsor Street. These recommendations, which will provide considerable improvements for transit service, are in accordance with the objectives of the MFTP and the IMP.

With approval of the recommendations in this report, the proposed transit priority corridors will move to the detailed design stage, which will provide further opportunity to refine the details of the corridor configuration and develop a comprehensive understanding of the implications of constructing the corridors. It is anticipated that detailed design will be completed using a combination of HRM staff resources and an external consultant, and will involve public and stakeholder engagement. Upon completion of the detailed design process, implementation will be subject to budget availability and approval of construction tenders by the CAO.

A projected implementation timeline has been developed for both the Gottingen Street and Bayers Road corridors. The recommended Gottingen Street transit priority corridor does not require property acquisition or significant construction works; therefore, it is anticipated that implementation can be completed during 2018. The recommended Bayers Road transit priority corridor configuration will require property acquisition and involves extensive construction works – it is possible that construction could be completed by 2020; however, there is potential that property acquisition could delay implementation beyond this timeframe.

BACKGROUND

The Halifax Transit *Moving Forward Together Plan* (MFTP), approved by Regional Council in April 2016, identifies Bayers Road and Gottingen Street as critical choke points for transit service into and out of downtown Halifax that require transit priority. To improve transit service on these corridors, the MFTP recommends investment in transit priority measures (TPMs) that provide priority to the movement of buses over general traffic.

In February 2017, Regional Council directed staff to enter into a contribution agreement with the federal government, under the Public Transit Infrastructure Fund (PTIF), for a project to study and design 'Transit Priority Corridors' on Bayers Road and Gottingen Street. The total project budget is \$250,000, the cost of which is being shared evenly between the municipality and federal government. The project, CM000014 Transit Priority Measures Corridor Study, is to be completed in two phases: a functional design study that identifies and evaluates design alternatives (Phase 1), followed by detailed design based on the preferred design options for the two corridors (Phase 2).

In May 2017, RFP 17-303 was awarded to WSP Canada Inc. (contract value \$133,664) to prepare functional designs for 'transit priority corridors' on Gottingen Street (North Street to Cogswell Street) and Bayers Road (Romans Avenue to Windsor Street), with the option to undertake the design of two further corridors pending direction from Regional Council through the Integrated Mobility Plan (IMP).

On December 5, 2017, Regional Council approved the IMP, which includes direction to prioritize the delivery of transit priority corridors on Bayers Road, Gottingen Street, Robie Street, and Young Street.

This report represents the conclusion of Phase 1 of this project.

Gottingen Street:

Gottingen Street is an arterial road that runs north-south between downtown Halifax and the north end of the Halifax peninsula. It has a diverse mixture of land uses, and recent, ongoing, and planned development projects are rapidly increasing the density of residential and commercial uses on the street. A key roadway linking downtown to the Macdonald Bridge and points further north, Gottingen Street has daily traffic volumes exceeding 8,500 vehicles per day. There is limited available right-of-way on Gottingen Street, and physical widening of the street or right-of-way is not a viable alternative.

Transit on Gottingen Street

There are currently 18 Halifax Transit routes that travel on Gottingen Street, totalling 79 buses per hour (2-way) during the peak hour. Planned changes in the MFTP will increase the number of buses using Gottingen Street to a total of 90 during the peak hour. Some routes along Gottingen Street provide limited stops, and two routes do not stop at all between Cogswell Street and North Street. Transit service on Gottingen Street is hindered by traffic congestion during peak periods, as well as by the need for buses to manoeuvre around vehicles stopped or parked in the curb lanes throughout the day. The relatively narrow street width makes these manoeuvres particularly challenging, and transit vehicles are delayed an average of 5-6 minutes in the northbound direction during the afternoon peak hour. These delays can be significantly higher when incident-related traffic congestion occurs.

Bayers Road

Bayers Road is an arterial road that runs east-west between Joseph Howe Drive and Windsor Street. It is characterized mostly by single family homes, and there are also several commercial properties found along the length of the corridor including the Halifax Shopping Centre. A key link in the regional roadway network, Bayers Road accommodates more than 40,000 vehicles per day. Traffic congestion is prevalent during peak periods, often resulting in significant delays.

The 2014 *Regional Municipal Planning Strategy* identifies expansion of the Bayers Road corridor for mixed traffic as a planned project to occur in conjunction with expansion of Highway 102 (Hammonds Plains Road to Bayers Road) by the Province. Specifically, this includes widening from four lanes to six lanes west of Connaught Avenue and widening from three lanes to four lanes between Connaught Avenue and Windsor Street. Though the corridor expansion has not yet been programmed for implementation, for several years the Municipality has been making strategic property acquisitions along Bayers Road to preserve the corridor. At present, most of the properties on either side of the section of Bayers Road between Highway 102 and Connaught Avenue are owned by HRM.

Transit on Bayers Road

At present, seven Halifax Transit routes travel on Bayers Road, totalling more than 40 buses per hour (2-way) during the peak hour. Planned changes in the MFTP will increase the number of buses using Bayers Road during the peak hour. Traffic congestion on Bayers Road has significant impacts to transit and reduces Halifax Transit's ability to provide a high quality, reliable service. Routes on Bayers Road regularly experience significant delays during peak periods – particularly during the afternoon – and at present, some trips on the Route 1 detour in the outbound direction on Roslyn Road to reduce delay.

Transit Priority Corridors

Bayers Road and Gottingen Street were identified as proposed transit priority corridors in the MFTP based on their importance for existing and planned transit operations, as well as the potential that they are expected to offer for providing priority to transit over general traffic. The type of transit priority proposed for the corridors was not identified in the Plan, recognizing that there are many factors that need to be considered in determining a preferred approach. The physical characteristics of the corridors, as well as how people use them, have a major influence on the type of transit priority measures that can be implemented.

Also, as is typical with any project that involves reconfiguration of an existing street, there are trade-offs that need to be considered. Where right-of-way expansion is necessary, impacts to private property and other infrastructure (e.g. water & sewer, power / communications lines, trees) may be required. Loss of traffic lanes and curb access used for on-street parking, loading, and stopping may also be necessary. These impacts are consistent with the IMP, which notes that parking management should be aligned with the goal of shifting more trips to active transportation, transit and car-sharing, while supporting growth in the Regional Centre. Effectively managing the supply of parking can help to influence travel habits and improved parking efficiency can reduce the amount of space needed for parking. As an initial phase of detailed design, a Parking Loss Mitigation Plan will be carried out in consultation with local Gottingen Street businesses to help ensure that adequate short-duration parking is provided for this important commercial area.

DISCUSSION

Following approval of the MFTP and securement of funding support from the Public Transit Infrastructure Fund (PTIF), Phase 1 of the project commenced after the selection of a consultant in May 2017 to complete a functional design study for the corridors. The primary objective of Phase 1 of the project was to investigate transit priority options and develop functional designs for transit priority corridors for Gottingen Street and Bayers Road. The scope of the consultant’s work included the following:

- Detailed investigation of existing conditions along each corridor and review of existing and projected multimodal transportation demands;
- Develop 2-3 conceptual design options representing a range of investment levels with input from the project steering committee and feedback from stakeholders;
- Public and stakeholder engagement related to the proposed design concepts;
- Identify any necessary property acquisition and utility relocation requirements for each option
- Evaluate multimodal level of service for the options that considers factors such as transit operational benefits, intersection performance impacts, parking / curb access, and road safety.

The consultant's findings and recommendations have been summarized in a design report appended to this report in **Attachment E**.

An overview of the Gottingen Street and Bayers Road corridors and the options considered for each are provided in **Attachment A** and **Attachment B**, respectively. The recommended options are summarized in the following sections:

Gottingen Street

Analysis Approach and Identification of Preferred Configuration

Options representing varying levels of investment (low, medium, and high) were considered for the proposed Gottingen Street transit priority corridor. A summary of the options that were considered is provided in **Attachment A** and further detailed in the consultant’s report in **Attachment E**. The preferred configuration for the Gottingen Street transit priority corridor, as summarized in Table 1, includes a dedicated northbound transit lane. Further detail and functional design sketches are provided on Pages 5-7 (**Attachment C**).

Table 1: Preferred Configuration Option – Gottingen Street Transit Priority Corridor

	Functional Sketch	Summary
Cogswell Street to North Street	 <p><i>Gottingen Street (looking to the south)</i></p>	<ul style="list-style-type: none"> • Continuous outbound (northbound) lane for buses only (also permitted for use by right turning vehicles); • Installation of pedestrian signals at key pedestrian crossings; • Removal of on-street parking and loading

Summary of Impacts:

A summary of the impacts associated with the recommended transit priority corridor option for Gottingen Street is provided below:

- *Transit Service:* Significant transit improvement in the northbound direction. Buses avoid obstruction by parked cars and can bypass lengthy queues, reducing delay and improving reliability. It is estimated that these corridor-level transit priority measures will substantially reduce delay for northbound buses, benefiting approximately 1600 peak hour passengers over 56 trips.

During heavily congested periods, it is estimated that buses will experience significant reductions in delay – running times on Gottingen Street suggest that buses are regularly delayed by 5-6 minutes during the PM peak, and in some cases up to 15 minutes. The proposed transit priority corridor will enable buses to avoid these major delays, which will improve schedule adherence during congested periods and play an important role in making the service more attractive to users.

- *Active Transportation:* Minimal impacts. The addition of signalized crosswalks improves street crossing experience.
- *Traffic Impacts:* Slight improvement to traffic flow due to removal of on-street parking.
- *Property Impacts:* No impacts to private property.
- *Parking / Loading:* Removal of all on-street parking and loading on Gottingen Street (51 spaces). There may be potential to allow short-term parking or loading during overnight hours when buses are not running. A 'Parking Loss Mitigation Plan' will be included in the detailed design stage of the project. Work on the plan has already begun and will include further engagement with local businesses. The plan will determine actual parking demand and will identify areas where it can be accommodated in the immediate vicinity, including additional parking on side streets.

Summary of Stakeholder and Public Consultation Feedback:

The Gottingen Street concept options were presented to the public at an Open House on Monday, October 2nd, 2017, and a Shape Your City online consultation page was established. Feedback on the design options was obtained (via survey) from a total of 296 members of the public. Results are provided in **Attachment D**. The addition of transit priority on Gottingen Street was deemed favorable by more than 60% of survey respondents. Among the potential trade-offs associated with implementation of the presented options (parking / loading, traffic congestion, increased bus traffic, and implementation costs), the leading concerns were increased traffic congestion, loss of loading access, and increased bus traffic on the street. However, none of the trade-offs were deemed unacceptable by most respondents.

HRM consulted with representatives from the North End Business Association (NEBA) on July 26th, 2017, to introduce the project and develop an understanding of the priorities and concerns of the local business community. The NEBA is concerned about how the project may impact Gottingen Street businesses and raised the following items for consideration:

- ***The potential loss of on-street parking and loading on Gottingen Street and its perceived impact on the viability of local businesses:*** As noted above, the detailed design stage of the project will include a 'Parking Loss Mitigation Plan' that includes a parking utilization study for Gottingen Street and the surrounding streets. While it is likely that there will be some net loss of on-street parking, this is consistent with curbside priority direction provided by the IMP, which prioritizes transit lanes over on-street parking and acknowledges the importance of replacing lost on-street parking where possible. Loading spaces will continue to be accommodated.
- ***The volume of buses that use Gottingen Street (existing and planned), and its perceived detrimental impact on the public realm:*** The public realm on Gottingen Street benefits from the significant number of people that buses bring to the street; this is also true for the businesses. Added transit priority will enable buses to move through the corridor more efficiently, thereby reducing the amount of bus idling on Gottingen Street while in traffic.
- ***The lack of consideration of alternatives that would reduce transit routing on Gottingen Street, including modified route configurations that could use alternate streets such as Barrington Street and Brunswick Street to service buses accessing the Macdonald Bridge (bus access to the bridge via these streets is constrained by the current ramp configuration):*** At present, Dartmouth bound buses must use Gottingen Street to access the Macdonald Bridge. Due to geometry on the Barrington Street ramp to the Macdonald Bridge, transit vehicles are unable to use this access. The Municipality and the Bridge Commission continue to work closely to investigate viable options that would permit this movement in a way that is safe, and enables buses to travel to Dartmouth from Halifax via Barrington Street. Interventions may be limited to small changes to the geometry of some road markings, however it is possible that it could require larger changes to the bridge ramp, which may be extremely costly.

However, even if the Barrington Street ramp did provide access for Dartmouth bound buses to the bridge, transit priority is still warranted on Gottingen Street for the buses which would still serve the many residents and businesses on this important corridor. There is high passenger demand on Gottingen Street: and this area is very walkable and is characterized by businesses and services which attract transit passengers and pedestrians alike. If the Barrington Street ramp were to be accessible to transit vehicles, only routes that do not currently make stops on Gottingen Street would benefit.



Brunswick Street is not considered a candidate for routing transit vehicles at this time. This street is a local street between Cogswell Street and North Street with lower traffic volumes, and the character of the street is largely residential. It lacks the commercial usage that Gottingen Street has, and thus does not have the same trip demand, attractions, or destinations. It is not currently possible for any vehicles to access the Macdonald bridge from Brunswick Street. At best, with the necessary intersection modifications at North Street, Brunswick Street could only accommodate buses travelling to Dartmouth and would not eliminate the need for transit priority on Gottingen Street.

Bayers Road

Analysis Approach and Identification of Preferred Configuration

Bayers Road was analyzed based on three distinct sections: (i) Romans Avenue to Halifax Shopping Centre, (ii) Halifax Shopping Centre and Connaught Avenue, and (iii) Connaught Avenue to Windsor Street. Multiple options representing varying levels of investment (low, medium, and high) were considered for the configuration of the proposed transit priority corridors for each section of Bayers Road. A summary of the options that were considered is provided in **Attachment B** and further detailed in the consultant's report in **Attachment E**. The preferred configuration for each of the three sections of Bayers Road are summarized in Table 2. Further detail and functional design sketches are provided on Pages 1-4 (**Attachment C**).

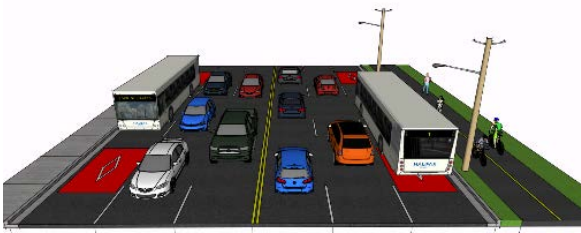
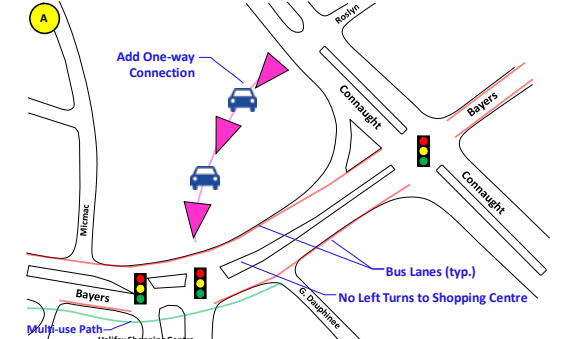
Table 2: Preferred Configuration Options – Bayers Road Transit Priority Corridor

	Functional Sketch	Summary
<p>Romans Avenue to Halifax Shopping Centre</p>	 <p><i>Bayers Road (looking to the east)</i></p>	<ul style="list-style-type: none"> Widen from existing 4-lane cross section to a 6-lane cross section; Add continuous eastbound and westbound dedicated bus lanes (also permitted for use by right turning vehicles); Add a multi-use pathway on the south side of Bayers Road; Most of required land has already been acquired by HRM, though more property acquisition will be required.
<p>Halifax Shopping Centre to Connaught Avenue</p>		<ul style="list-style-type: none"> Left turns into Halifax Shopping Centre prohibited from Bayers Road, removing key source of congestion. Add new one-way driveway connection to the Halifax Shopping Centre across HRM-owned vacant parcel. New connection provides increased capacity for traffic entering the Halifax Shopping Centre. Further consultation with the Halifax Shopping Centre will be required. Add continuous eastbound and westbound dedicated bus lanes (also permitted for use by right turning vehicles);
<p>Connaught Avenue to Windsor Street</p>	 <p><i>Bayers Road (looking to the east)</i></p>	<ul style="list-style-type: none"> Widen from existing 3-lane cross section to a 4-lane cross section; Add continuous eastbound and westbound dedicated bus lanes (also permitted for use by right turning vehicles); Property acquisition will be required. Several properties are affected, though it is not anticipated that impacts will be extensive. Removal of on-street parking and loading.

Summary of Impacts:

A summary of the impacts associated with the recommended transit priority corridor option for Bayers Road is provided below:

- Transit Service:** Significant transit improvement in both directions, as buses avoid the traffic congestion that frequently occurs during peak periods. For example, it is estimated that these corridor-level transit priority measures will substantially reduce delay for outbound buses during the PM peak – running times on Bayers Road suggest that buses are regularly delayed by 13-14 minutes during the PM peak, and in some cases by up to 28 minutes (these improvements would benefit approximately 530 peak hour passengers, over 25 trips). The proposed transit priority corridor will enable buses to avoid these major delays, which will improve schedule adherence during congested periods and play an important role in making the service more attractive to users.
- Active Transportation:** Multi-use path west of Connaught Avenue provides improved walking / cycling connection.
- Traffic Impacts:** Slight improvement to traffic flow due to removal of buses from general traffic and decreased delay at the reconfigured Halifax Shopping Centre driveway intersection. The closely spaced intersections at Connaught Avenue and Bayers Road would benefit considerably from the intersection configuration, reducing confusion and operational challenges for all users.

- *Property Impacts:* Widening in constrained areas will require property acquisition. West of the Halifax Shopping Centre, most of required land has already been acquired by HRM, though more property acquisition will be required. East of Connaught Avenue, several properties may be affected, though the majority will not be significantly impacted (narrow strips of property frontage required).
- *Parking / Loading:* Loss of approximately 50 on-street parking spaces on Bayers Road between Connolly Street and Dublin Street.

Summary of Stakeholder and Public Consultation Feedback:

The Bayers Road corridor concept options were presented to the public at an Open House on Thursday, September 28th, and a Shape Your City online consultation page was established. Feedback on the design options was obtained (via survey) from a total of 488 members of the public. Results are provided in **Attachment D**. The addition of dedicated bus lanes on Bayers Road received a favorable response from more than 70% of respondents. Among the potential trade-offs associated with implementation of the presented options (property impacts, parking / loading, traffic congestion, increased bus traffic, and implementation costs), the potential for increased traffic congestion was the lone category that most respondents (54%) indicated was unacceptable.

HRM consulted with representatives from the Halifax Shopping Centre to review the concept options as they relate to the shopping centre driveway intersection. Based on preliminary feedback, Halifax Shopping Centre representatives have concerns about potential modifications to the existing access configuration, but indicated that they are open to further consultation as the project progresses.

Recommended Approach for the proposed Transit Priority Corridors:

It is recommended that both the Bayers Road and Gottingen Street Transit Priority Corridors be advanced to the detailed design stage. The recommended configuration for each corridor is described below:

Gottingen Street: Continuous northbound transit lane between Cogswell Street and North Street. Since the Gottingen Street options are quite scalable (most of the changes include modifications to signage, signals, and pavement markings and do not require land acquisition or have significant impacts to physical infrastructure), the recommended option could be modified relatively easily depending on how the facility operates and/or how its impacts to the street are perceived. Consideration could also be given to permitting on-street parking in the transit lane during specific periods with limited transit service such as overnight. Recommendations from the Parking Loss Mitigation Plan noted above will be included in the detailed design.

Bayers Road: Dedicated bus lanes (both directions) on Bayers Road between Romans Avenue and Windsor Street, and reconfiguration of the Halifax Shopping Centre intersection to include a new at-grade access leg via the HRM-owned vacant property at 6699 Bayers Road. During the detailed design process, further investigation should be completed to determine a preferred intersection configuration for the Halifax Shopping Centre driveway. Consultation with representatives from the Halifax Shopping Centre should also be continued during the design process.

Next Steps / Implementation Plan

At the February 21, 2017 meeting of Regional Council, Halifax Regional Council directed staff to provide an implementation plan for the Gottingen Street and Bayers Road corridors that allows consideration of the potential for construction during the 2019-20 fiscal year. The following describes the next steps that are anticipated to be required for implementation of both corridors.

Gottingen Street:

Based on Regional Council approval of the recommendations outlined in this report, an approximate implementation timeline is summarized in Table 3. Detailed design of the transit priority corridor will be completed by HRM staff. During detailed design, public and stakeholder engagement will be completed to provide opportunity for additional feedback on the design and related impacts.

Implementation of the recommended Gottingen Street transit priority corridor does not require property acquisition or significant construction works; therefore, it is anticipated that implementation can be completed during 2018.

Table 3: Estimated Implementation Timeline - Gottingen Street Transit Priority Corridor

Task	2018							
	J	F	M	A	M	J	J	A
1. Detailed Design ^{a b}								
2. Construction Tendering								
3. Award of Construction Tender ^c								
4. Construction								
Notes:								
a. Assumes Regional Council approval of staff recommendations in February 2018.								
b. Detailed design completed by HRM Planning & Development and Transportation & Public Works.								
c. CAO award of construction tender will be subject to budget availability.								

Bayers Road:

Based on Regional Council approval of the recommendations outlined in this report, an approximate implementation timeline is summarized in Table 4. Implementation of the Bayers Road transit priority corridor is significantly more complex than for Gottingen Street, and will require additional time, budget, and resources. Due to the anticipated need to acquire private property, there is also more schedule uncertainty.

A consultant will be retained to complete detailed design. During detailed design, public and stakeholder engagement will be completed to provide opportunity for additional feedback on the design and related impacts. Based on the detailed design, property acquisition requirements will be identified, and a construction budget estimate will be developed. The process of acquiring private property will have uncertain timelines that could delay the project. Award of a construction tender by the CAO will be required, subject to budget availability. Construction timelines are also uncertain, though it is expected that at least 3-4 months will be required.

Based on the estimated implementation timeline, it appears possible that construction of the proposed Bayers Road transit priority corridor can be completed by 2020. However, it is noted that certain elements of the implementation process – primarily property acquisition – do have the potential to delay the project to 2021 or beyond.

Table 4: Estimated Implementation Timeline - Bayers Road Transit Priority Corridor

Task	2018				2019				2020			
	Winter	Spring	Summer	Fall	Winter	Spring	Summer	Fall	Winter	Spring	Summer	Fall
1. Issue and Award RFP for Detailed Design ^a												
2. Detailed Design ^b												
3. Property Acquisition ^c												
4. Construction Tendering												
5. Award of Construction Tender ^d												
6. Construction ^e												

Notes:

- Assumes Regional Council approval of staff recommendations in February 2018.
- Detailed design completed by consultant.
- Property acquisition requirements will be determined based on the detailed design. The process of acquiring private property has uncertain timelines, and may vary considerably depending on the amount of property required.
- CAO award of construction tender will be subject to budget availability.
- Construction timelines for this project are uncertain. Mitigation of construction-related impacts on traffic will likely be desired due to the significance of the Bayers Road corridor. It has been assumed that construction will commence during spring, coinciding with the start of the road construction season.

Robie Street / Young Street: As recommended in the IMP, transit priority corridors are also being investigated on Robie Street and Young Street. Staff are currently working with WSP Canada Inc. on a functional design study for the two corridors. The design process will include public engagement in February 2018. Upon completion of the functional design study, a recommendation report will be submitted to Regional Council seeking direction to proceed to detailed design for a recommended corridor configuration. This report will also describe an estimated timeline for implementation of these corridors, which may include phasing. It is anticipated that the report will be submitted to Regional Council in spring 2018.

FINANCIAL IMPLICATIONS

The evaluation of the corridor options considered both capital and operating costs relative to operational benefits in identifying a preferred, cost-effective approach. The detailed design for Bayers Road will be funded from CM000014 Transit Priority Measures Corridor Study, the cost of which is estimated to be within the balance of \$116,336 available in the project account. The Bayers Road detailed design is funded through the Public Transit Infrastructure Fund (PTIF), which provides up to 50% of the project costs. The detailed design work for Gottingen Street will be undertaken by HRM staff resources at no additional cost to the Municipality.

Budget Summary: Project Account No. CM000014 Transit Priority Measures Corridor Study

Cumulative Unspent Budget	\$ 116,336
Less: estimated detailed design cost	<u>\$(116,336)</u>
Balance	\$ 0

The Gottingen Street transit priority corridor construction work – estimated at approximately \$250,000, but subject to detailed design – will be funded from project account CM000009, Transit Priority Measures, pending the approval of the 2018/19 capital budget.

Budget Summary: Project Account No. CM000009 Transit Priority Measures

Cumulative Unspent Budget	\$392,390
Anticipated 2018/19 Budget	\$350,000
Less: estimated construction cost	<u>\$(250,000)</u>
Balance	\$ 492,390

Construction of the recommended Bayers Road transit priority corridor is not budgeted at this time – the preliminary Class D cost estimate for construction, excluding property acquisition, is \$4.8 million – but the design will allow tender/construction to proceed when the funding opportunity/decision occurs.

RISK CONSIDERATION

There are no significant risks associated with the recommendations of this report. The risks considered rate low.

COMMUNITY ENGAGEMENT

Stakeholder and public consultation was completed to develop an understanding of the key issues on each corridor and solicit feedback on the presented concept designs.

- Stakeholder consultation sessions were held with the following groups:
 - North End Business Association
 - Halifax Shopping Centre (20Vic Management)
 - Halifax Cycling Coalition
 - It's More Than Buses
 - Walk & Roll
 - Canadian National Institute for the Blind (CNIB)
 - Dalhousie Transportation Collaboratory (DalTrac)

The information obtained from these groups was considered during the development of the design options, and incorporated into the options evaluation process.

- Public open consultation sessions were held for each of the Gottingen Street and Bayers Road corridors:
 - Bayers Road: Thursday, September 28th – Maritime Hall
 - Gottingen Street: Monday, October 2nd – George Dixon Centre

In addition, a Shape Your City online engagement portal was established for each corridor. Feedback was collected via in-person comments, a paper feedback survey, and an online survey (there were a total of 488 respondents for the Bayers Road survey, and 296 respondents for the Gottingen Street survey). The information obtained from public consultation was used to develop an understanding of priorities on each corridor and evaluate public response to the design options. Survey results are summarized in **Attachment D**.

Further engagement with Gottingen Street businesses, relative to on-street parking and loading impacts and the Halifax Shopping Centre, relative to its intersection at Bayers Road, will continue for both projects as they proceed through the detailed design process.

ENVIRONMENTAL IMPLICATIONS

This project is supportive of the Council Priority Outcome of building Healthy, Livable communities, as it aims to make it more convenient for residents to choose sustainable transportation options for everyday transportation purposes. This is reflected in the enhancements for transit, but also the improvements for

pedestrians and cyclists.

ALTERNATIVES

The Transportation Standing Committee may recommend to Regional Council that some or all of the recommendations not be approved or be modified. Alternatives for each of the Gottingen Street and Bayers Road and corridors are presented below:

Gottingen Street:

1. The Committee may recommend that Regional Council direct staff to introduce a 12-month pilot of a northbound transit lane on Gottingen Street in order to observe and monitor the impacts it may have on transit service reliability as well as local businesses and residents. This alternative is not recommended, as the transit benefits of the proposed measures are well understood at this time, and more than 60% of consultation survey respondents showed support for the measures.
2. The Committee may recommend that Regional Council direct staff to proceed to detailed design of intermittent transit priority measures in the northbound direction. This alternative is not recommended; while it does provide transit priority benefits, the overall transit benefit is considerably less than the continuous priority included in the high investment option, and the additional cost is only marginally lower.
3. The Committee may recommend that Regional Council direct staff to implement peak period parking / loading restrictions or recommend that no changes be made to the Gottingen Street corridor. These alternatives are not recommended, as they do not provide transit priority benefits contemplated by the MFTP and IMP.

Bayers Road:

1. The Committee may recommend that Regional Council direct staff to proceed to detailed design of dedicated bus lanes (both directions) on Bayers Road without reconfiguration to the Halifax Shopping Centre intersection. This alternative is not recommended, as it is not expected that effective transit priority can be provided through the section between Halifax Shopping Centre and Connaught Avenue under the existing intersection configuration.
2. The Committee may recommend that Regional Council direct staff to proceed to detailed design of a dedicated westbound bus lane on Bayers Road between Romans Avenue and Windsor Street. This alternative is not recommended, since it provides transit priority only in the outbound direction and does not achieve the benefits contemplated by the MFTP and IMP.
3. The Committee may recommend that Regional Council make no changes to the Bayers Road corridor. This alternative is not recommended, as it does not achieve the benefits contemplated by the MFTP and IMP.

ATTACHMENTS

Attachment A: Gottingen Street Summary and Design Options Overview

Attachment B: Bayers Road Summary and Design Options Overview

Attachment C: Functional Design Drawings

Attachment D: Community Consultation Results Summary

Attachment E: *Halifax Transit Priority Corridors: Gottingen Street and Bayers Road* (WSP, November 2017)

A copy of this report can be obtained online at halifax.ca or by contacting the Office of the Municipal Clerk at 902.490.4210.

Report Prepared by: Mike Connors, P.Eng., Transportation Engineer, Planning & Infrastructure, 902.817.0795

Report Approved by: Patricia Hughes, Manager Planning & Scheduling, Halifax Transit 902.490.6287

Report Approved by: Peter Duncan, Manager Infrastructure Planning, Planning & Development, 902.490.5449

Attachment A: Gottingen Street Summary and Options Overview

The Gottingen Street corridor was investigated between North Street and Cogswell Street (See Figure 1).

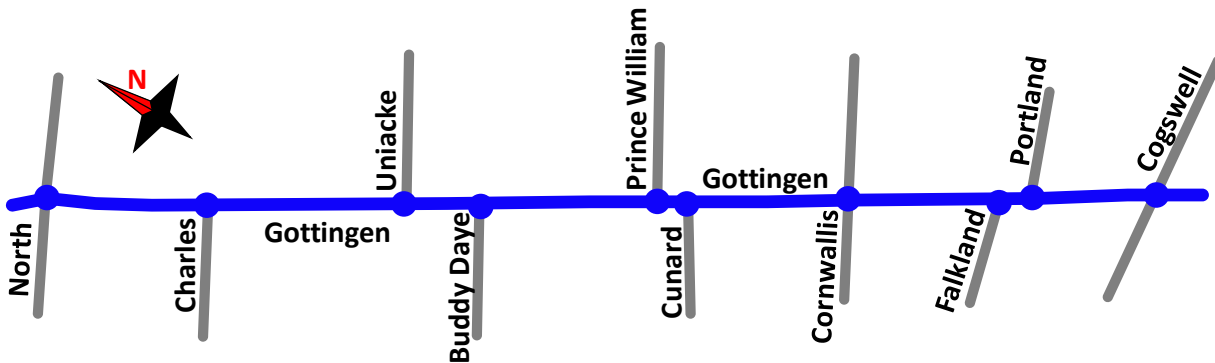

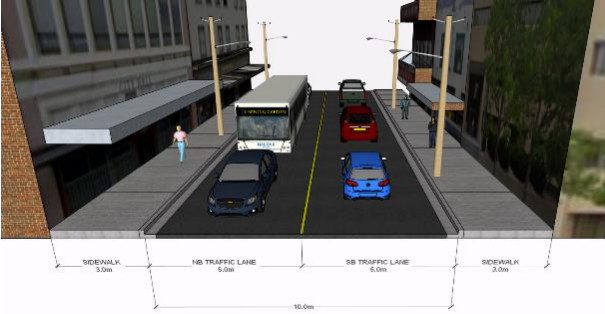

Figure 1: Gottingen Street Corridor

Table 1: Existing Conditions – Gottingen Street Corridor

<p>Vehicle Traffic</p>	<p>Key arterial street that provides a north-south connection between downtown Halifax and the bridge, as well as the north end and beyond</p> <p>Two lanes south of Uniacke Street</p> <p>Three lanes (2 northbound, 1 southbound) between Uniacke Street and North Street</p>
<p>Pedestrians / Cyclists</p>	<p><i>Walking:</i> An urban street with a diverse mixture of land uses, Gottingen Street is a busy pedestrian area. There are sidewalks on both sides of the street, though sidewalk width and separation from traffic lanes are limited by the narrow available right-of-way.</p> <p><i>Cycling:</i> Gottingen Street does not have any current or planned bicycle facilities. With a relatively narrow cross section and extensive transit service, it is not considered an ideal cycling route.</p>
<p>Transit</p>	<p>The Gottingen Street Corridor is served by the following routes at peak: 1, 7, 10, 11, 21, 31, 33, 34, 41, 53, 59, 61, 68, 86, 159, 320, 330, and 370. This is a total of approximately 79 trips at in the peak hour.</p> <p>The biggest impediment to bus operation on Gottingen Street is interaction with vehicles parked or stopped along the curb, which requires buses to awkwardly manoeuvre to get by them. The narrow curb-to-curb width exacerbates the challenges, often disrupting the flow of traffic in both directions.</p>
<p>Property Ownership</p>	<p>Available right-of-way along Gottingen Street is very limited. The typical curb-to-curb width is 10m, and building setbacks on both sides are typically very tight. It is not expected that property acquisition for the purposes of widening to expand the street is a viable approach.</p>
<p>Adjacent Land Uses</p>	<p>Diverse mix of residential and commercial</p>
<p>Parking and Loading</p>	<p>There are approximately 51 on-street parking spaces on Gottingen Street between Cogswell Street and Uniacke Street, all of which are time-limited (peak period, peak direction parking is restricted).</p> <p>Loading activities are completed from the existing parking spaces, in addition to one designated loading zone and any other locations not designated as 'No Stopping'.</p>

The design options presented in Table 2, which represent varying levels of investment, were developed for Gottingen Street. Functional design drawings, along with an overview of the implications (transit improvements and impacts to traffic, parking, and adjacent land uses), advantages, and disadvantages for the options for each section are provided on Pages 5 to 7, Attachment C.

Table 2: Design Options – Gottingen Street Corridor

	Description	Summary of Impacts
<p>Low Investment: Peak Period Parking / Stopping Restrictions</p>	 <ul style="list-style-type: none"> No explicit transit priority measures Parking and stopping restricted on both sides of the street during AM and PM peak periods 	<ul style="list-style-type: none"> Transit Service: Does not provide priority for buses over general traffic, though transit delays may improve due to improvements to general traffic flow Walking: No impact. Bicycling: Minimal impact. Fewer conflicts with parked vehicles. Traffic Impacts: Improved traffic flow during AM and PM peak periods. Property Impacts: No impact. Parking / Loading: Removal of all on-street parking and loading on Gottingen Street during peak periods only.
<p>Medium Investment: Intermittent Outbound Transit Priority Measures</p>	 <ul style="list-style-type: none"> Installation of transit queue jump lanes at key locations; Installation of pedestrian half signals at key pedestrian crossings; 	<ul style="list-style-type: none"> Transit Service: Transit priority at key locations provide moderate service improvement. Walking: Minimal impact. The addition of signalized crosswalks improves street crossing experience. Bicycling: Minimal impact. Fewer conflicts with parked vehicles. Traffic Impacts: Improved traffic flow during AM and PM peak periods. Property Impacts: No impact. Parking / Loading: Removal of all on-street parking and loading on Gottingen Street during peak periods only.
<p>High Investment: Continuous Outbound Transit Priority Lane</p>	 <ul style="list-style-type: none"> Continuous outbound (northbound) lane for buses only (also permitted for use by right turning vehicles); Installation of pedestrian half signals at key pedestrian crossings; 	<ul style="list-style-type: none"> Transit Service: Continuous bus lane and transit priority lane provides significant service improvement. Walking: Minimal impact. The addition of signalized crosswalks improves street crossing experience. Bicycling: Minimal impact. Fewer conflicts with parked vehicles. Traffic Impacts: Improved traffic flow during AM and PM peak periods. Property Impacts: No impact. Parking / Loading: Full-time removal of all on-street parking and loading on Gottingen Street

Attachment B: Bayers Road Summary and Options Overview

Bayers Road

Due to the varying widths and conditions found along the Bayers Road corridor, for the purposes of this investigation it has been separated into the following three distinct sections (illustrated in Figure 1).

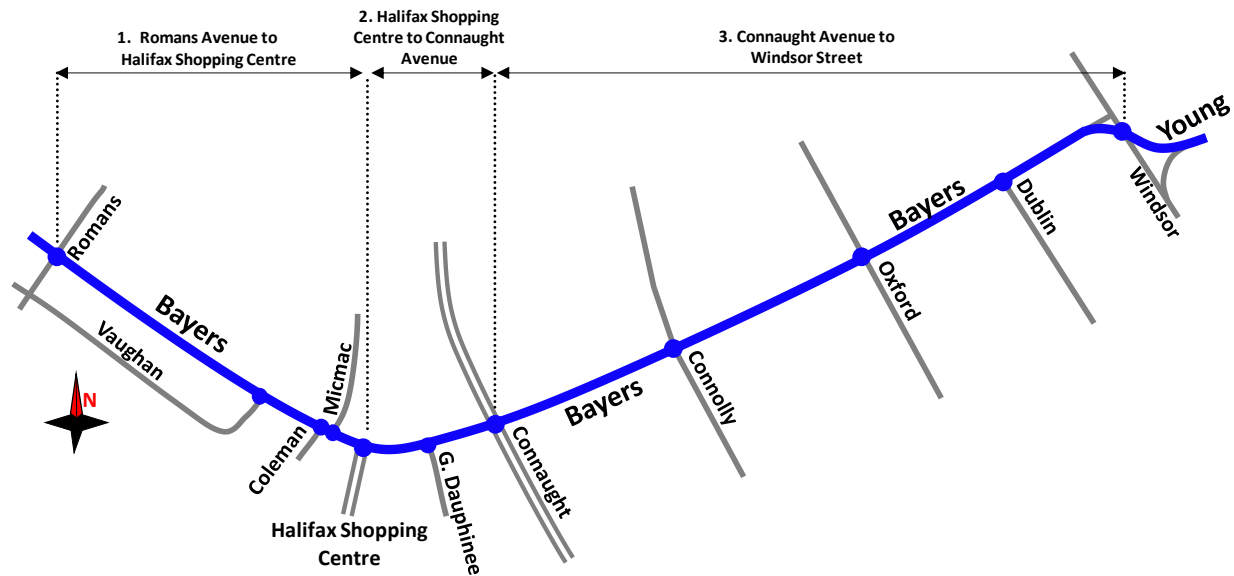

Figure 1: Bayers Road Corridor

Table 1 summarizes existing conditions for the three sections of Bayers Road related to vehicular traffic, active transportation, transit, property ownership, adjacent land uses, and parking / loading.

Table 1: Existing Conditions – Bayers Road Corridor

	Vehicle Traffic	Pedestrians / Cyclists	Transit	Property Ownership	Adjacent Land Uses	Parking and Loading
Romans Avenue to Halifax Shopping Centre	<p>Four lanes (2 lanes each direction) separated by a median</p> <p>Heavy traffic volumes and high delays during AM / PM peak periods</p>	<p><i>Walking:</i> Though there are existing sidewalks, it is not an ideal walking environment due to heavy traffic volumes and a lack of separation between the sidewalk and traffic lanes, which reduces comfort for pedestrians.</p> <p><i>Cycling:</i> Not currently an ideal cycling route due to heavy traffic volumes and lack of dedicated space for bicycles.</p>	<p>Used by routes 2, 17, 80, 81, 2, and 330</p> <p>Currently 20-25 buses (2-way) per hour in the PM peak</p>	<p>HRM owns majority of property on both sides of the street due to long-term corridor preservation efforts.</p>	<p>Residential</p>	<p>No existing designated on-street parking or loading areas</p>
Halifax Shopping Centre to Connaught Avenue	<p>5-6 lanes (including turn lanes to Halifax Shopping Centre)</p> <p>Short separation (approx. 100m) between Shopping Centre intersection and Connaught Avenue results in spillback of queues, causing congestion.</p> <p>Interaction of queues between intersections complicates access to local land uses including Halifax Shopping Centre.</p>	<p><i>Walking:</i> Existing sidewalks and separation from traffic provide good walking environment.</p> <p><i>Cycling:</i> Not currently an ideal cycling route due to heavy traffic volumes and lack of dedicated space for bicycles.</p>	<p>Used by routes 1, 29, 17, 80, 81, 2, and 330</p> <p>Currently 30-35 buses (2-way) per hour in the PM peak</p>	<p>HRM owns the parcel on the northwest corner of the Bayers Road – Connaught Avenue intersection</p>	<p>Primarily commercial</p>	
Connaught Avenue to Windsor Street	<p>Three lanes (2 westbound, 1 eastbound)</p> <p>Heavy traffic volumes and high delays during AM / PM peak periods</p>	<p><i>Walking:</i> Existing sidewalks and separation from traffic provide good walking environment.</p> <p><i>Cycling:</i> Not currently an ideal cycling route due to heavy traffic volumes and lack of dedicated space for bicycles.</p>	<p>Used by routes 1, 17, 80, 81, and 330</p> <p>Currently 25-30 buses (2-way) per hour in the PM peak</p>	<p>Private</p>	<p>Primarily residential with some commercial</p>	

The design options considered for the section of Bayers Road between Romans Avenue and the Halifax Shopping Centre are summarized in Table 2. Further detail and functional design sketches are provided on Page 1 (Attachment C).

Table 2: Design Options – Bayers Road (Romans Avenue to Halifax Shopping Centre)

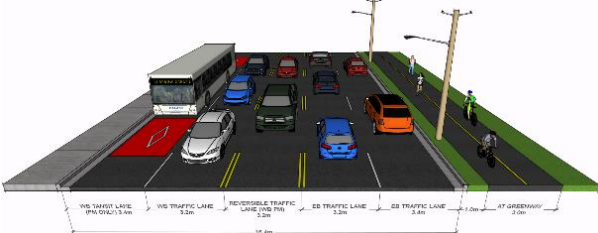
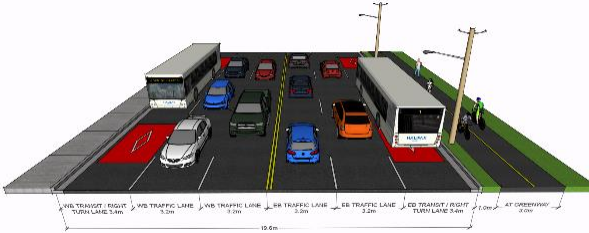
	Description	Summary of Impacts
<p>Medium Investment: Reversible Peak Direction Transit Lane</p>	 <ul style="list-style-type: none"> • Add a reversible dedicated bus lane (also permitted for use by right turning vehicles) that serves eastbound buses before noon and westbound buses after noon; • Requires reversible lane signage and pavement markings, similar to Chebucto Road. • Installation of a multi-use pathway on the south side of Bayers Road; 	<ul style="list-style-type: none"> • Transit Service: Significant transit improvement in the peak direction. Buses can bypass congestion, reducing delay and improving reliability. • Walking: Multi-use path provides increased separation between pedestrians and vehicular traffic. • Bicycling: Multi-use path provides high quality cycling connection, makes an important connection in AT Priorities Plan. • Traffic Impacts: Slight improvement to traffic flow due to removal of buses from general traffic. • Property Impacts: Requires the acquisition of a limited amount of property on the south side of Bayers Road. • Parking / Loading: No impact.
<p>High Investment: Continuous Eastbound and Westbound Transit Lanes</p>	 <ul style="list-style-type: none"> • Add continuous eastbound and westbound dedicated bus lanes (also permitted for use by right turning vehicles); • Installation of a multi-use pathway on the south side of Bayers Road; 	<ul style="list-style-type: none"> • Transit Service: Significant transit improvement in the both directions. Buses can bypass lengthy queues, reducing delay and improving reliability. • Walking: Multi-use path provides increased separation between pedestrians and vehicular traffic. • Bicycling: Multi-use path provides high quality cycling connection, makes an important connection in AT Priorities Plan. • Traffic Impacts: Slight improvement to traffic flow due to removal of buses from general traffic. • Property Impacts: Requires the acquisition of property on the south side of Bayers Road. Marginally more property is required than for the medium investment option. • Parking / Loading: No impact.

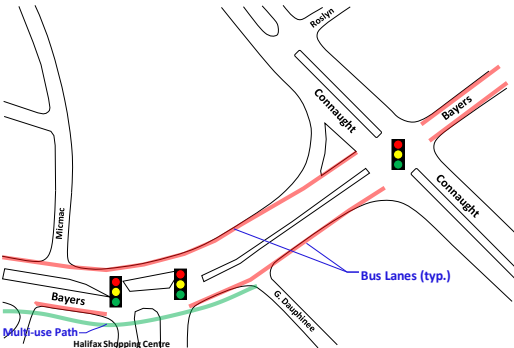
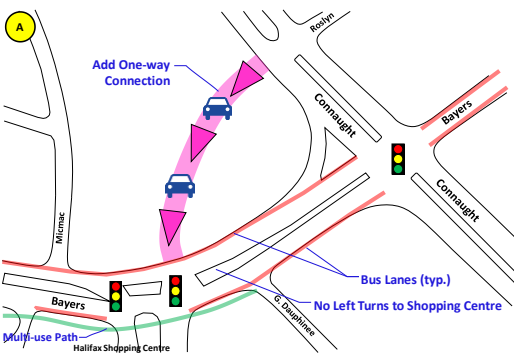
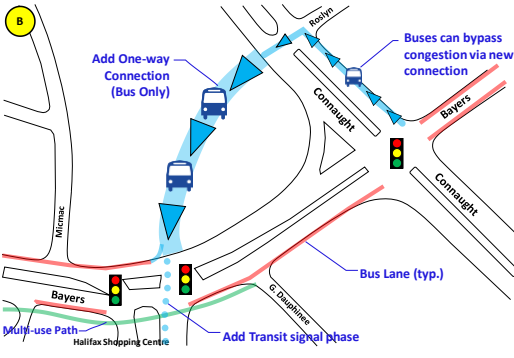
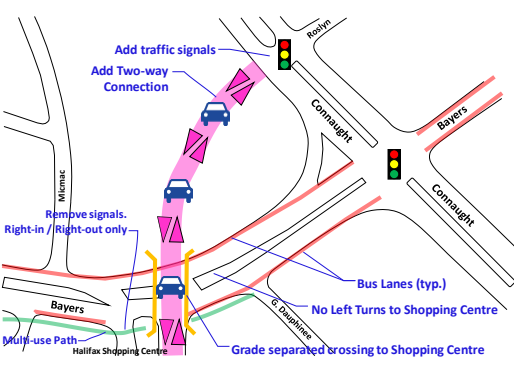

The design options considered for the section of Bayers Road between the Halifax Shopping Centre and Connaught Avenue are summarized in Table 3. Further detail and functional design sketches are provided on Page 2 (Attachment C).

Table 3: Design Options – Bayers Road (Halifax Shopping Centre to Connaught Avenue)

	Functional Sketch	Summary
<p>Low Investment: Dedicated Bus Lanes (Both Directions)</p>		<ul style="list-style-type: none"> • Eastbound and westbound dedicated bus lanes • Property acquisition required on south side of Bayers Road • Improves operation for through buses, but left turns to Halifax Shopping Centre remain a challenge. • Increasing roadway width extends pedestrian crossing distance
<p>Medium Investment: Reconfigured Shopping Centre Intersection with Dedicated Bus Lanes (Both Directions)</p>		<ul style="list-style-type: none"> • Add new one-way driveway connection to Shopping Centre across HRM-owned vacant parcel. • Eastbound and westbound dedicated bus lanes without need to widen Bayers Road. • Left turns into mall prohibited from Bayers Road, removing key source of congestion. New connection provides increased capacity for traffic entering Shopping Centre. • Less direct access for vehicles entering Shopping Centre.
<p>Medium Investment: Reconfigured Shopping Centre Intersection with Dedicated Bus Lanes (Both Directions)</p>		<ul style="list-style-type: none"> • Add new one-way driveway connection to Shopping Centre across HRM-owned vacant parcel <u>for buses only</u>. • Eastbound dedicated bus lane without need to widen Bayers Road. • Westbound buses can bypass congestion via new connection. Buses destined to Shopping Centre divert to new connection and proceed via transit signal phase. • Existing traffic access configuration for Shopping Centre is not impacted.
<p>High Investment: Grade Separated Crossing to Shopping Centre with Dedicated Bus Lanes (Both Directions)</p>		<ul style="list-style-type: none"> • Add new grade separated, two-way connection (bridge) to Shopping Centre across HRM-owned vacant parcel. • Remove signals from Shopping Centre intersections. Add signals to Connaught Avenue – Roslyn Road intersection. • Eastbound and westbound dedicated bus lanes without need to widen Bayers Road. • Less direct access for vehicles entering Shopping Centre, but higher capacity than existing.

The design options considered for the section of Bayers Road between Connaught Avenue and Windsor Street are summarized in Table 4. Further detail and functional design sketches are provided on Pages 3-4 (Attachment C).

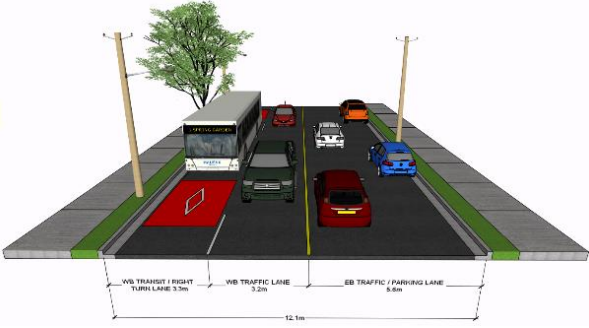
Table 4: Design Options – Bayers Road (Connaught Avenue to Windsor Street)

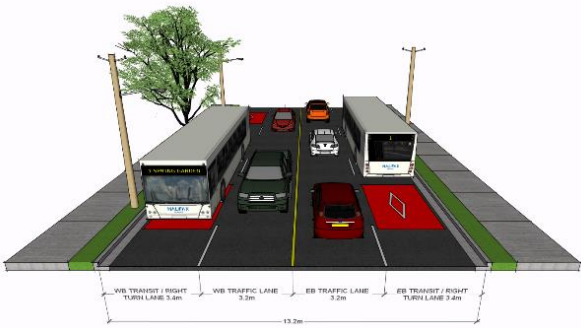
	Description	Summary of Impacts
<p>Low Investment: Westbound Transit Lane</p>	 <ul style="list-style-type: none"> • Continuous westbound dedicated bus lane (also permitted for use by right turning vehicles); 	<ul style="list-style-type: none"> • Transit Service: Significant transit improvement in the westbound direction. Buses can bypass lengthy queues, reducing delay and improving reliability. • Walking: No impact. • Bicycling: No impact. • Traffic Impacts: Loss of one westbound traffic lane; removal of buses from general westbound traffic flow • Property Impacts: No Impact. • Parking / Loading: Modified parking restrictions.
<p>Medium Investment: Reversible Peak Direction Transit Lane</p>	 <ul style="list-style-type: none"> • Reversible dedicated bus lane (also permitted for use by right turning vehicles) that serves eastbound buses before noon and westbound buses after noon; • Requires reversible lane signage and pavement markings, similar to Chebucto Road. 	<ul style="list-style-type: none"> • Transit Service: Significant transit improvement in the peak direction. Buses can bypass lengthy queues, reducing delay and improving reliability. • Walking: No impact. • Bicycling: No impact. • Traffic Impacts: Slight improvement to traffic flow in the peak direction due to removal of buses from general traffic. • Property Impacts: Requires minimal property acquisition, primarily on the south side of Bayers Road. • Parking / Loading: Loss of on-street parking between Connolly Street and Dublin Street.
<p>High Investment: Continuous Eastbound and Westbound Transit Lanes</p>	 <ul style="list-style-type: none"> • Continuous eastbound and westbound dedicated bus lanes (also permitted for use by right turning vehicles); 	<ul style="list-style-type: none"> • Transit Service: Significant transit improvement in the both directions. Buses can bypass lengthy queues, reducing delay and improving reliability. • Walking: No impact. • Bicycling: No impact. • Traffic Impacts: Slight improvement to traffic flow due to removal of buses from general traffic. • Property Impacts: Requires property acquisition, primarily on the south side of Bayers Road. • Parking / Loading: Loss of on-street parking between Connolly Street and Dublin Street.

BAYERS RD. - ROMANS AVE. TO HALIFAX SHOPPING CENTRE

OPTION 1 - HIGH INVESTMENT: DEDICATED BUS LANES (BOTH DIRECTIONS)



	Significant improvements to the flow of public transit.
	No major impacts. Slight improvement to traffic flow expected.
	New 3m off-street AT greenway.
	No impact.
	Impacts to properties along the corridor due to required road widening.

IMPACTS

PROS

- Will significantly improve transit movement in both directions at all times.
- Improves right-turn movement Bayers to Romans.
- Provides new AT greenway.

CONS

- Requires roadway expansion.
- Impacts residential properties along the corridor.

OPTION 2 - MEDIUM INVESTMENT: PEAK DIRECTION 'REVERSIBLE' BUS LANES

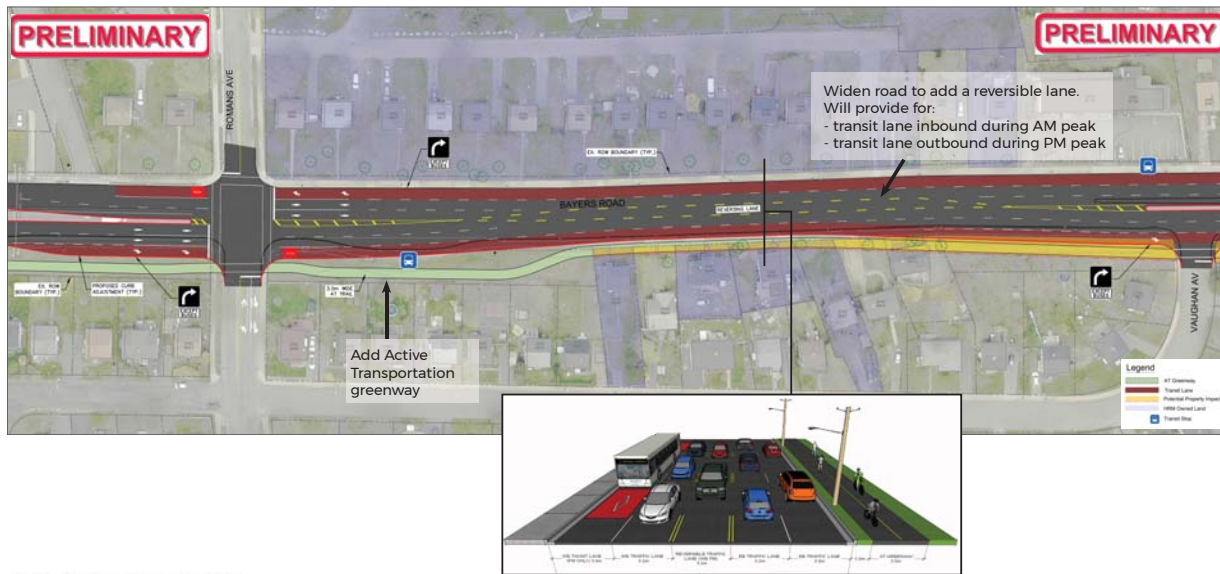

	Improvement to the flow of public transit.
	No major impacts. Slight improvement expected.
	New 3m off-street AT greenway.
	No impact.
	Impacts to properties along the corridor, but to a lesser extent than Option A (due to a reduced widening requirement).

IMPACTS

PROS

- Will improve transit movement in peak direction only.
- Improves right-turn movement Bayers to Romans.
- Provides new AT greenway.
- Lower impacts on adjacent residential properties along the corridor.

CONS

- Requires roadway expansion.
- Only prioritizes transit one way (peak direction).

BAYERS RD. - HALIFAX SHOPPING CENTRE TO CONNAUGHT AVE.

OPTION 1 - HIGH INVESTMENT: MODIFIED HALIFAX SHOPPING CENTRE DRIVEWAY (WITH BRIDGE) AND DEDICATED BUS LANES (BOTH DIRECTIONS)

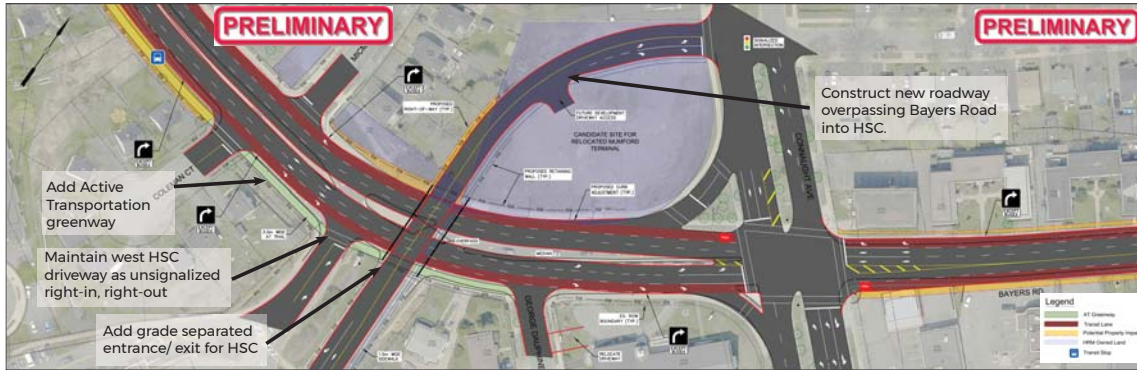

IMPACTS

	Significant improvements to the flow of public transit.
	Significant improvement of traffic flow with removal of HSC signals.
	New 3m off-street AT greenway. Grade separated crossing of Bayers Road.
	No impact.
	Properties will be impacted to allow for roadway adjustments.

PROS

- Will significantly improve transit movement via transit lanes.
- Reduces merging conflicts into Halifax Shopping Centre.
- Alleviates queuing impacts by removing signal at HSC.
- Provides new Active Transportation greenway.

CONS

- High level of investment (cost).
- High level of impact to adjacent properties.
- Prolonged disruption during construction.

OPTION 2 - MEDIUM INVESTMENT: MODIFIED HALIFAX SHOPPING CENTRE DRIVEWAY (REALIGNED INTERSECTION) AND DEDICATED BUS LANES (BOTH DIRECTIONS)

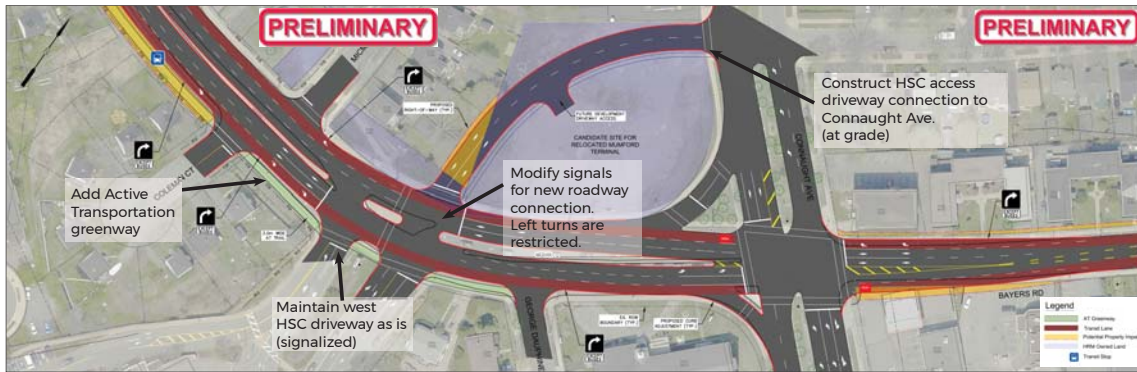

IMPACTS

	Significant improvements to the flow of public transit.
	Improvement of traffic flow with intersection re-alignment.
	New 3m off-street AT greenway.
	No impact.
	Properties will be impacted to allow for roadway adjustments.

PROS

- Will significantly improve transit movement via transit lanes.
- Reduces merging conflicts into HSC.
- Eases through-moving traffic between Connaught and HSC.
- Provides new AT greenway.

CONS

- Maintains close signal spacing along Bayers Road.
- Moderate level of impact to adjacent properties.

OPTION 3 - LOW INVESTMENT: DEDICATED BUS LANES (BOTH DIRECTIONS)

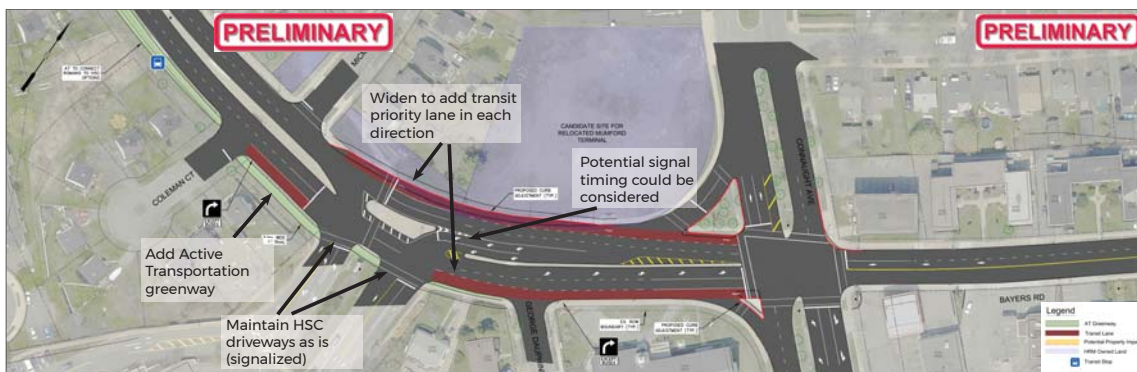

IMPACTS

	Moderate improvements to the flow of public transit.
	No major impacts to traffic flow. Slight improvement expected.
	New 3m off-street AT greenway.
	No impact.
	Slight impacts to properties with AT trail.

PROS

- Will move public transit more effectively than what is currently in place.
- Provides new AT greenway.
- Reduced impacts to adjacent properties.

CONS

- Does not improve transit operations at Connaught Ave. in the outbound direction.
- Will not address queuing and merging issues caused by closely spaced intersections.

BAYERS RD. - CONNAUGHT AVE. TO OXFORD ST.

OPTION 1 - HIGH INVESTMENT: DEDICATED BUS LANES (BOTH DIRECTIONS)

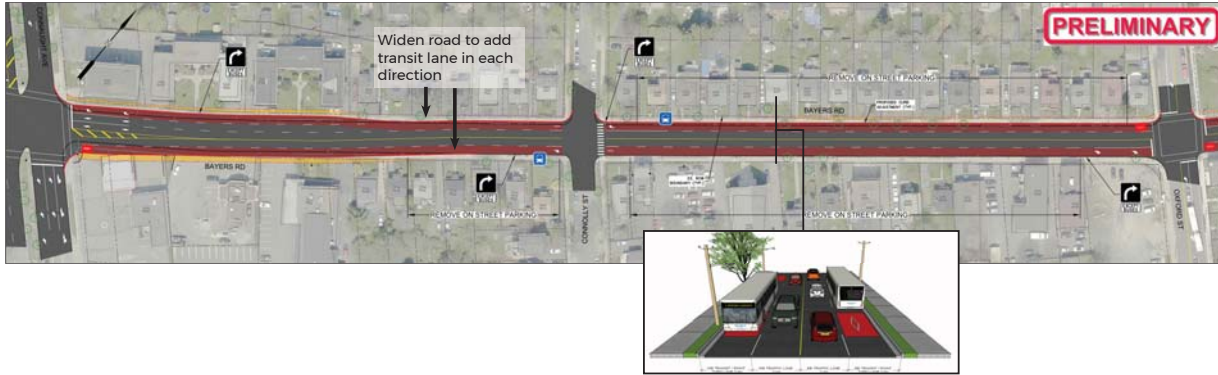

IMPACTS	
Bus	Significant improvements to the flow of public transit inbound and outbound.
Car	Fewer outbound lanes available.
Ped/Bike	No impact.
Parking	Removal of on-street parking.
House	Slight road widening may impact properties along the corridor.

PROS	
•	Will significantly improve transit movement, particularly during PM peak periods.
CONS	
•	Fewer travel lanes for through-moving vehicles on Bayers Road.
•	Road widening is required and may impact properties along the corridor.
•	Removal of on-street parking

OPTION 2 - MEDIUM INVESTMENT: PEAK DIRECTION 'REVERSIBLE' BUS LANES



IMPACTS	
Bus	Improvements to the flow of public transit during peak periods.
Car	Fewer outbound lanes available.
Ped/Bike	No impact
Parking	Removal of on-street parking.
House	No major impacts

PROS	
•	Will improve transit movement in peak directions.
•	Significantly less road widening required (reduction in property impacts).
CONS	
•	Does not benefit transit in off-peak direction.
•	Fewer travel lanes for through-moving vehicles on Bayers Road.
•	Removal of on-street parking

OPTION 3 - LOW INVESTMENT: WESTBOUND (OUTBOUND) DEDICATED BUS LANE



IMPACTS	
Bus	Minimally improves flow of public transit.
Car	Fewer outbound lanes available.
Ped/Bike	No impact
Parking	Modified parking restrictions.
House	No major impact

PROS	
•	No impact to on-street parking and adjacent properties.
CONS	
•	Minimal improvement for public transit relative to existing conditions.
•	Challenges for traffic congestion remain.
•	Potential parking loss.

BAYERS RD. - OXFORD ST. TO WINDSOR ST.

OPTION 1 - HIGH INVESTMENT: DEDICATED BUS LANES (BOTH DIRECTIONS)

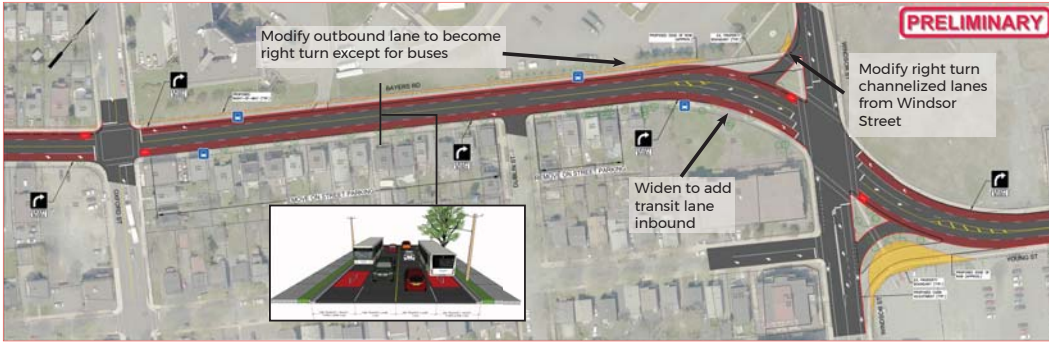

IMPACTS

Significant improvements to the flow of public transit inbound and outbound.
Fewer outbound lanes available for the corridor segment (Windsor to Oxford).
No impact
Reduced time available for on street parking.
Slight road widening may impact properties along the corridor.

PROS

- Will significantly improve transit movement, particularly during PM peak periods.
- Improve right-turn movement from Bayers Rd. to Oxford St. and Bayers Rd. to Windsor St.
- Improves visibility of right-turns at Windsor/ Bayers/ Young intersection.
- More land available at Windsor/Bayers/ Young intersection for streetscaping.

CONS

- Road widening is required and may impact properties along the corridor.
- Fewer travel lanes for through-moving vehicles on Bayers Rd.
- Reduced time available for on-street parking.

OPTION 2 - MEDIUM INVESTMENT: PEAK DIRECTION 'REVERSIBLE' BUS LANES

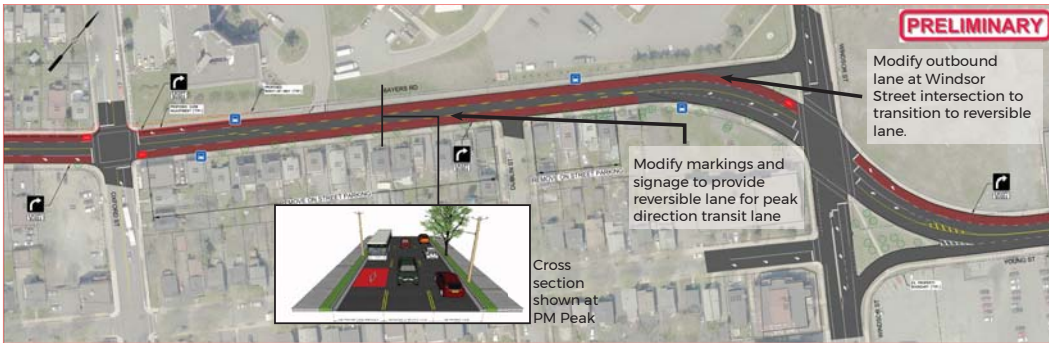

IMPACTS

Improvements to the flow of public transit during peak periods.
Fewer outbound lanes available for the corridor segment (Windsor to Oxford).
No impact
Reduced time available for on street parking.
No major impacts

PROS

- Will significantly improve transit movement, particularly during PM peak periods.
- Improve right-turn movement from Bayers to Oxford during PM peak.
- Significantly less road widening required (reduction in property impacts).

CONS

- Will reduce benefit to transit in off-peak direction.
- Fewer travel lanes for through-moving vehicles on Bayers Road.
- Reduced time available for on street parking.

OPTION 3 - LOW INVESTMENT: WESTBOUND (OUTBOUND) DEDICATED BUS LANE



IMPACTS

Minimally improves flow of public transit.
Fewer outbound lanes available for the corridor segment (Windsor to Oxford).
No impact
Modified parking restrictions.
No impact

PROS

- Will improve transit movement in outbound direction, particularly during PM peak periods.
- Improve right-turn movement from Bayers to Oxford during PM peak.
- No road widening required.
- No on street parking impacts.

CONS

- Minimal improvement for public transit relative to existing conditions.
- Fewer travel lanes for through-moving vehicles on Bayers Road.
- Potential parking loss.

GOTTINGEN ST. - CORNWALLIS ST. TO COGSWELL ST.

OPTION 1 - HIGH INVESTMENT: CONTINUOUS OUTBOUND (NORTHBOUND) TRANSIT PRIORITY LANE

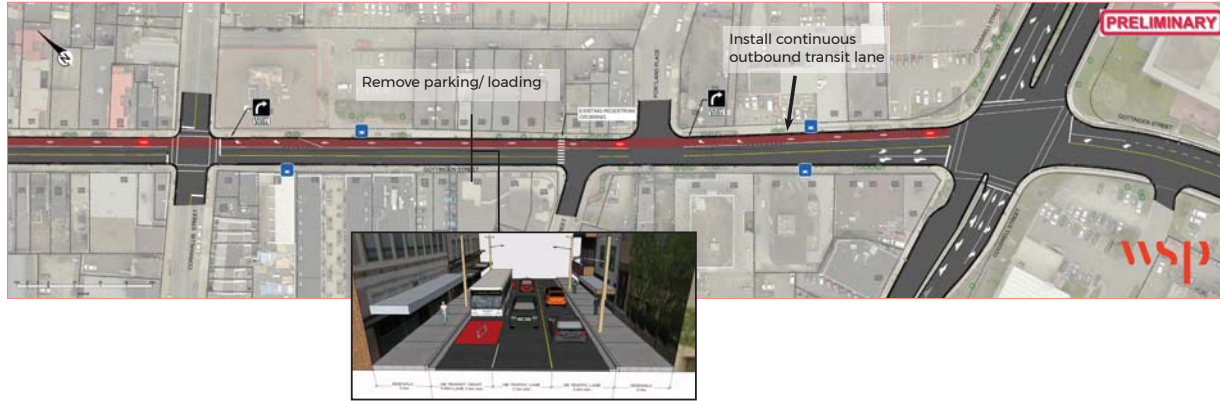

IMPACTS



Improvements to the flow of transit in the outbound (northbound) direction.

Slightly improved traffic flow.

Reduced conflicts with parked vehicles.

No impact.

Full-time loss of parking / loading. Anticipated relocation of some parking / loading to nearby streets.

PROS

- Continuous improvement to transit flow in outbound (northbound) direction.
- Improvement to transit schedule reliability in outbound (northbound) direction.
- High visibility transit priority.
- Potential to increase compliance of parking and loading restrictions.
- Some improvement to the flow of traffic during peak periods.

CONS

- Full-time loss of parking / loading

OPTION 2 - MEDIUM INVESTMENT: INTERMITTENT OUTBOUND (NORTHBOUND) TRANSIT PRIORITY MEASURES

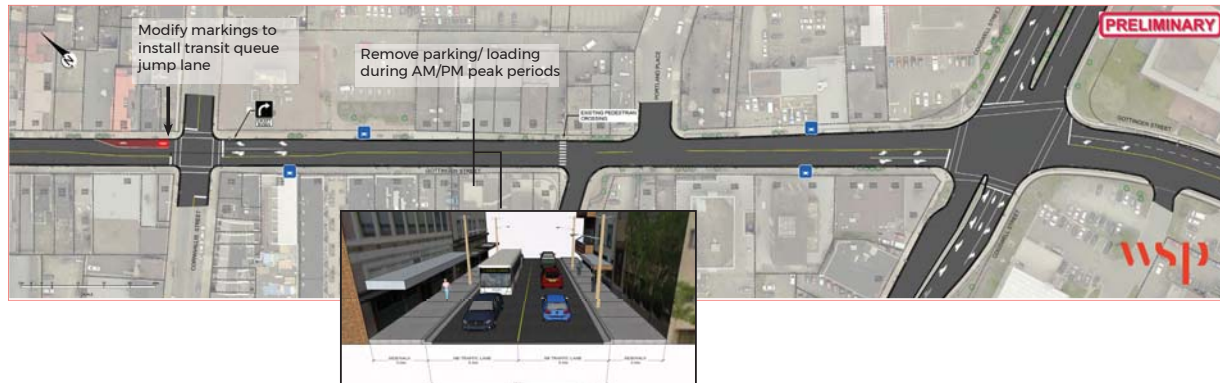

IMPACTS



Slight improvement to the flow of transit in outbound direction.

Slightly improved traffic flow during peak periods.

Reduced conflicts with parked vehicles.

No impact

Loss of parking/loading during peak periods. Anticipated relocation of some parking / loading to nearby streets.

PROS

- Slight improvement to traffic and transit flow during peak periods.
- Some improvement to transit schedule reliability.
- Easy to implement, low cost.

CONS

- Not expected to provide the desired level of transit priority on this busy transit corridor.
- Loss of parking / loading during peak periods.

OPTION 3 - LOW INVESTMENT: PEAK PERIOD PARKING / LOADING / STOPPING RESTRICTIONS



IMPACTS



Slight improvement to the flow of transit during peak periods.

Slightly improved traffic flow during peak periods

Reduced conflicts with parked vehicles.

No impact

Loss of parking/loading during peak periods. Anticipated relocation of some parking / loading to nearby streets.

PROS

- Slight improvement to traffic and transit flow during peak periods.
- Slight improvement to transit schedule reliability during peak periods.
- Easy to implement, low cost.

CONS

- Does not prioritize transit.
- Loss of parking / loading during peak periods.

GOTTINGEN ST. - UNIACKE ST. TO CORNWALLIS ST.

OPTION 1 - HIGH INVESTMENT: CONTINUOUS OUTBOUND (NORTHBOUND) TRANSIT PRIORITY LANE

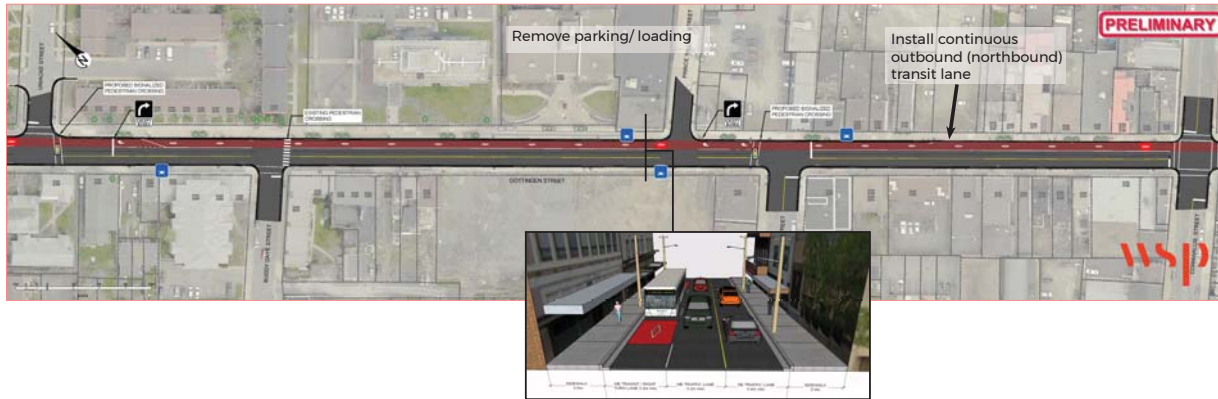

IMPACTS

- Improvements to the flow of transit in the outbound (northbound) direction.
- Slightly improved traffic flow.
- Reduced conflict with parked vehicles.
- Added signalized crossings of Gottingen St. at Cunard St. and Uniacke St.
- Full-time loss of parking / loading. Anticipated relocation of some parking / loading to nearby streets.

PROS

- Continuous improvement to transit flow in outbound (northbound) direction.
- Improvement to transit schedule reliability in outbound direction.
- High visibility transit priority.
- Potential to increase compliance of parking and loading restrictions.
- Signalized crosswalk will provide a higher visible crossing for pedestrians.
- Some improvement to the flow of traffic during peak periods.

CONS

- Full-time Loss of parking / loading

OPTION 2 - MEDIUM INVESTMENT: INTERMITTENT OUTBOUND (NORTHBOUND) TRANSIT PRIORITY MEASURES

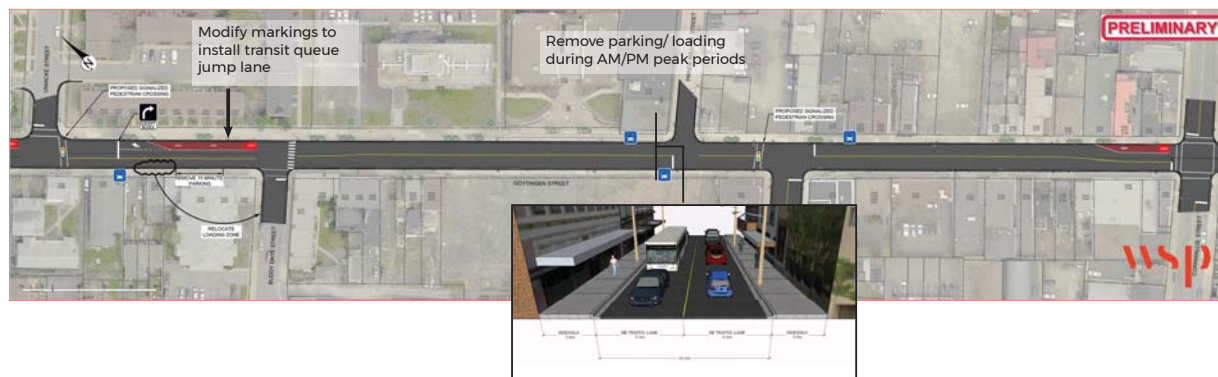

IMPACTS

- Slight improvement to the flow of transit in outbound direction.
- Slightly improved traffic flow during peak periods.
- Reduced conflict with parked vehicles.
- No impact
- Loss of parking/loading during peak periods. Anticipated relocation of some parking / loading to nearby streets.

PROS

- Slight improvement to traffic and transit flow during peak periods.
- Some improvement to transit schedule reliability.
- Easy to implement, low cost.

CONS

- Not expected to provide the desired level of transit priority on this busy transit corridor.
- Loss of parking / loading during peak periods.

OPTION 3 - LOW INVESTMENT: PEAK PERIOD PARKING / LOADING / STOPPING RESTRICTIONS

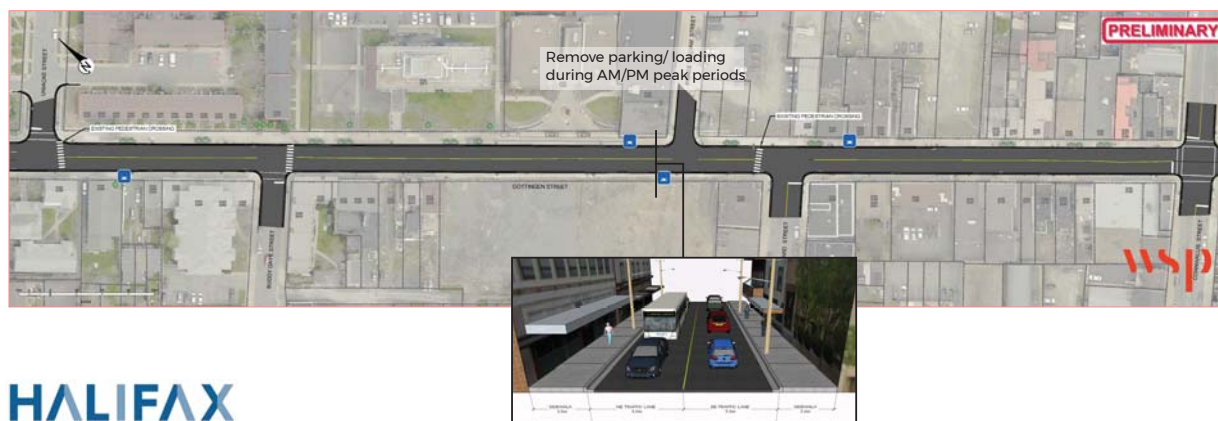

IMPACTS

- Slight improvement to the flow of transit during peak periods.
- Slightly improved traffic flow.
- Reduced conflicts with parked vehicles.
- No impact
- Loss of parking/loading during peak periods. Anticipated relocation of some parking / loading to nearby streets.

PROS

- Slight improvement to traffic and transit flow during peak periods.
- Slight improvement to transit schedule reliability during peak periods.
- Easy to implement, low cost.

CONS

- Does not prioritize transit
- Loss of parking / loading during peak periods

GOTTINGEN ST. - NORTH ST. TO UNIACKE ST.

OPTION 1 - HIGH INVESTMENT: CONTINUOUS OUTBOUND (NORTHBOUND) TRANSIT PRIORITY LANE



IMPACTS	
	Improvements to the flow of transit in the outbound (northbound) direction.
	Impacts right-turn movement toward Macdonald Bridge.
	Reduced conflict with parked vehicles.
	Added signalized crossings of Gottingen St. at Uniacke St.
	Full-time loss of parking / loading. Anticipated relocation of some parking / loading to nearby streets.

- PROS**
- Continuous improvement to transit flow in outbound (northbound) direction.
 - Improvement to transit schedule reliability in outbound direction.
 - High visibility transit priority.
 - Signalized crosswalk will provide a higher visible crossing for pedestrians.
- CONS**
- Full-time Loss of loading.

OPTION 2 - MEDIUM INVESTMENT: INTERMITTENT OUTBOUND (NORTHBOUND) TRANSIT PRIORITY MEASURES



IMPACTS	
	Slight improvement to the flow of transit in outbound (northbound) directions.
	Impacts right-turn movement toward Macdonald Bridge.
	No impact.
	Added signalized crossings of Gottingen St. at Uniacke St.
	No parking on section modified to no stopping during peak periods.

- PROS**
- Slight improvement to traffic and transit flow during peak periods.
 - Some improvement to transit schedule reliability.
 - Easy to implement, low cost
 - Signalized crosswalk will provide a higher visible crossing for pedestrians.
- CONS**
- Not expected to provide the desired level of transit priority on this busy transit corridor.
 - Loss of loading during peak periods.

OPTION 3 - LOW INVESTMENT: PEAK PERIOD PARKING / LOADING / STOPPING RESTRICTIONS



IMPACTS	
	No major impact to this section of Gottingen Street.
	No major impact.
	No impact.
	No impact.
	No parking on section modified to no stopping during peak periods.

- PROS**
- Easy to implement, low cost.
- CONS**
- Does not prioritize transit.
 - Loss of loading during peak periods.

HALIFAX

Bayers Road / Gottingen Street Transit Priority Corridors

Public Feedback Survey Summary

October-19-17

Bayers Road

Shape Your City Online Survey	469
Paper Survey	19
Total Participants	488

Bayers Road

How often do you use Bayers Road?

of Responses

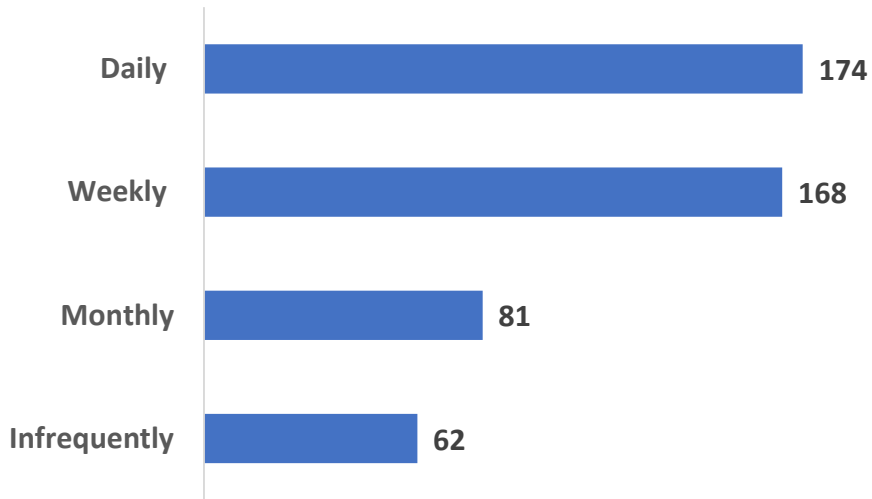

How do you usually travel on Bayers Road?

of Responses

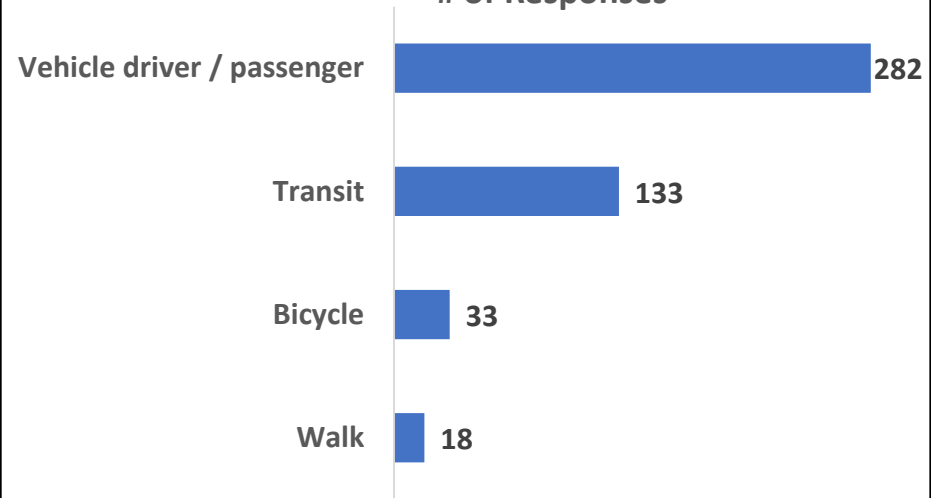

Bayers Road

What matters most to you when you use Bayers Road? (select up to 3)

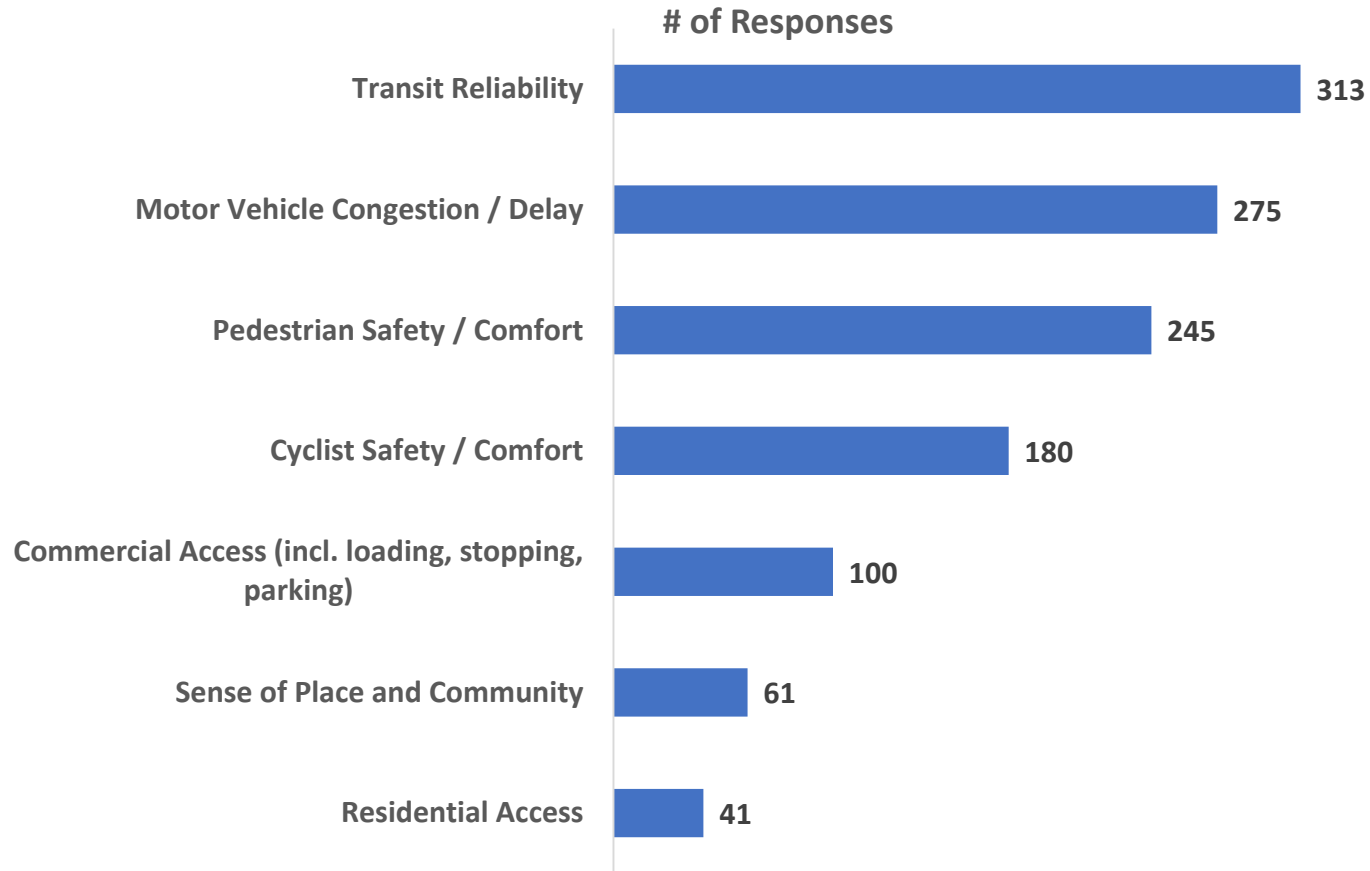

Bayers Road

On a scale from 1-4 (where 1 is poor and four is excellent) how would you rate your experiences on Bayers Road?

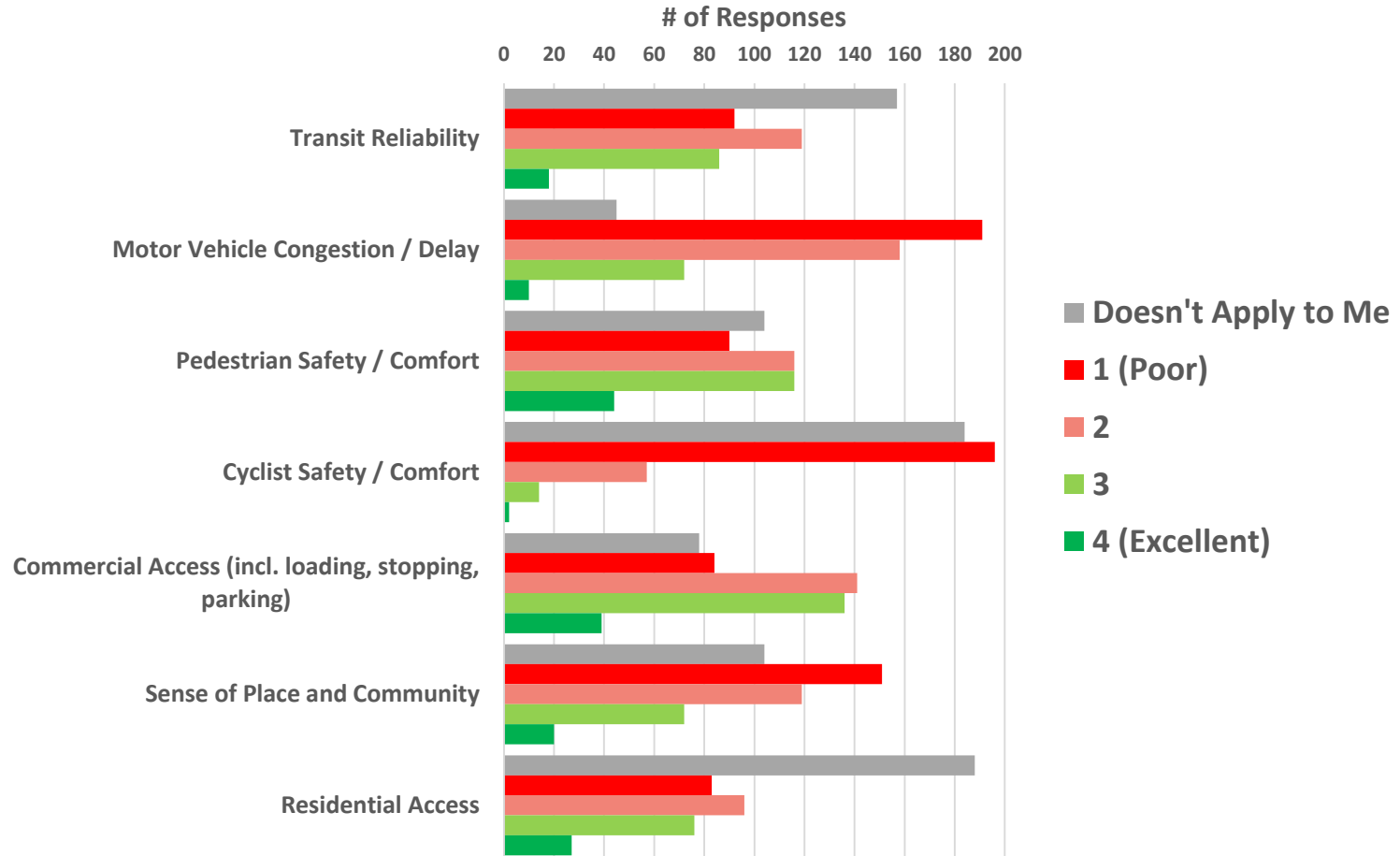

Bayers Road

The addition of transit priority lanes on Bayers Road may require trade-offs in some locations. How acceptable are the following potential trade-offs?

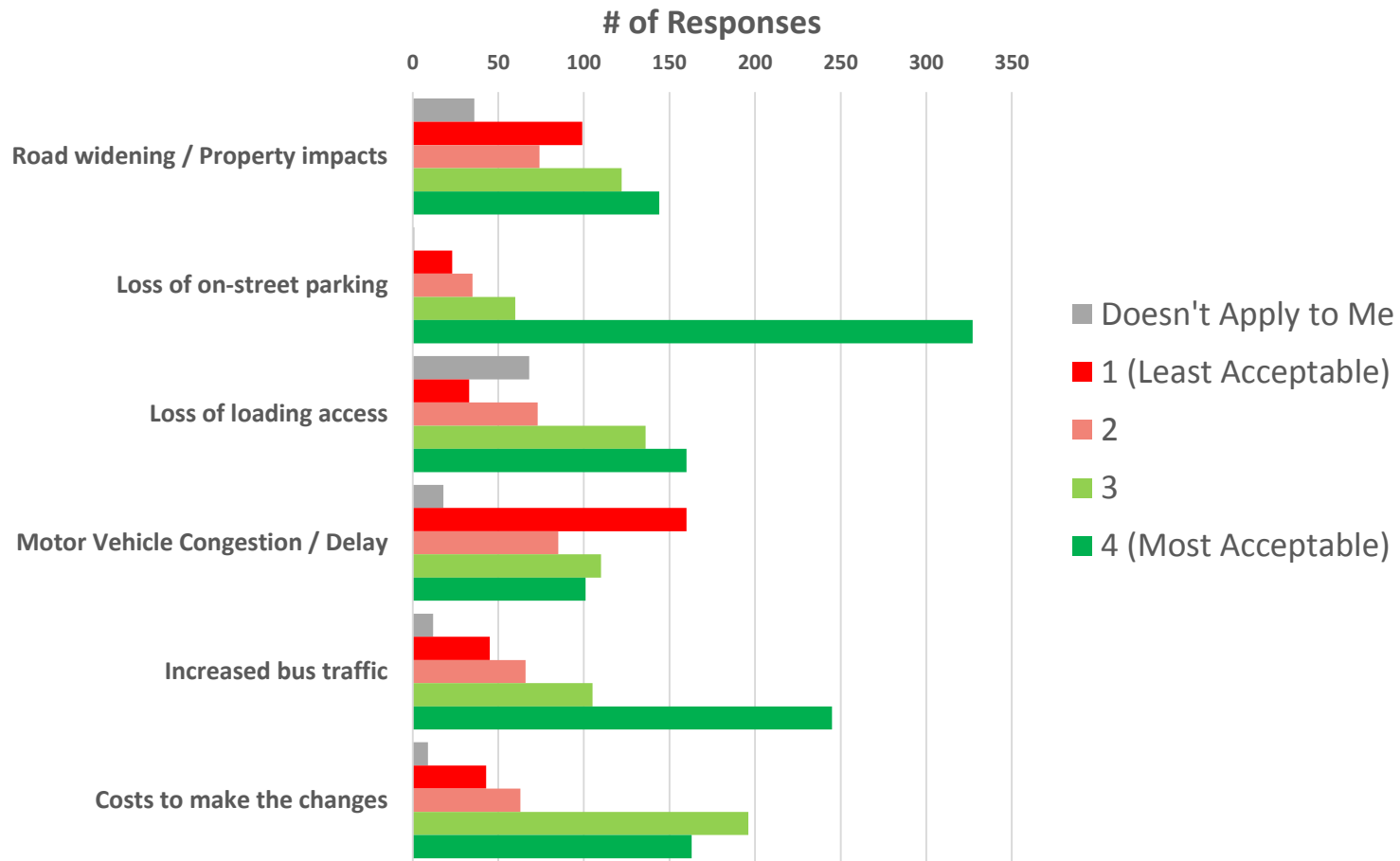

Bayers Road

Section 1 (Romans Ave. to Halifax Shopping Centre):
Indicate your preference based on the presented concepts

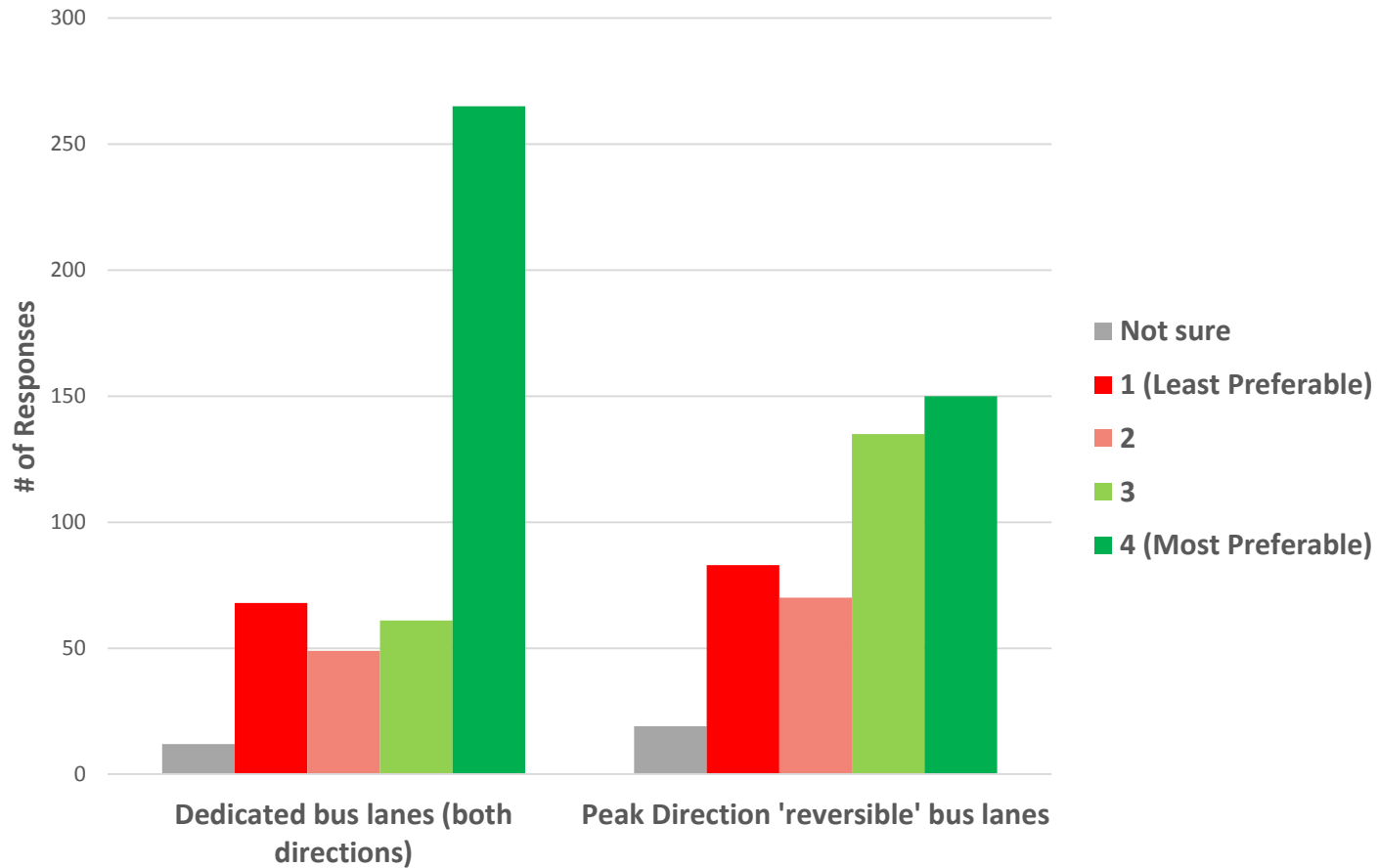

Bayers Road

Section 2 (Halifax Shopping Centre to Connaught Ave.):
Indicate your preference based on the presented concepts

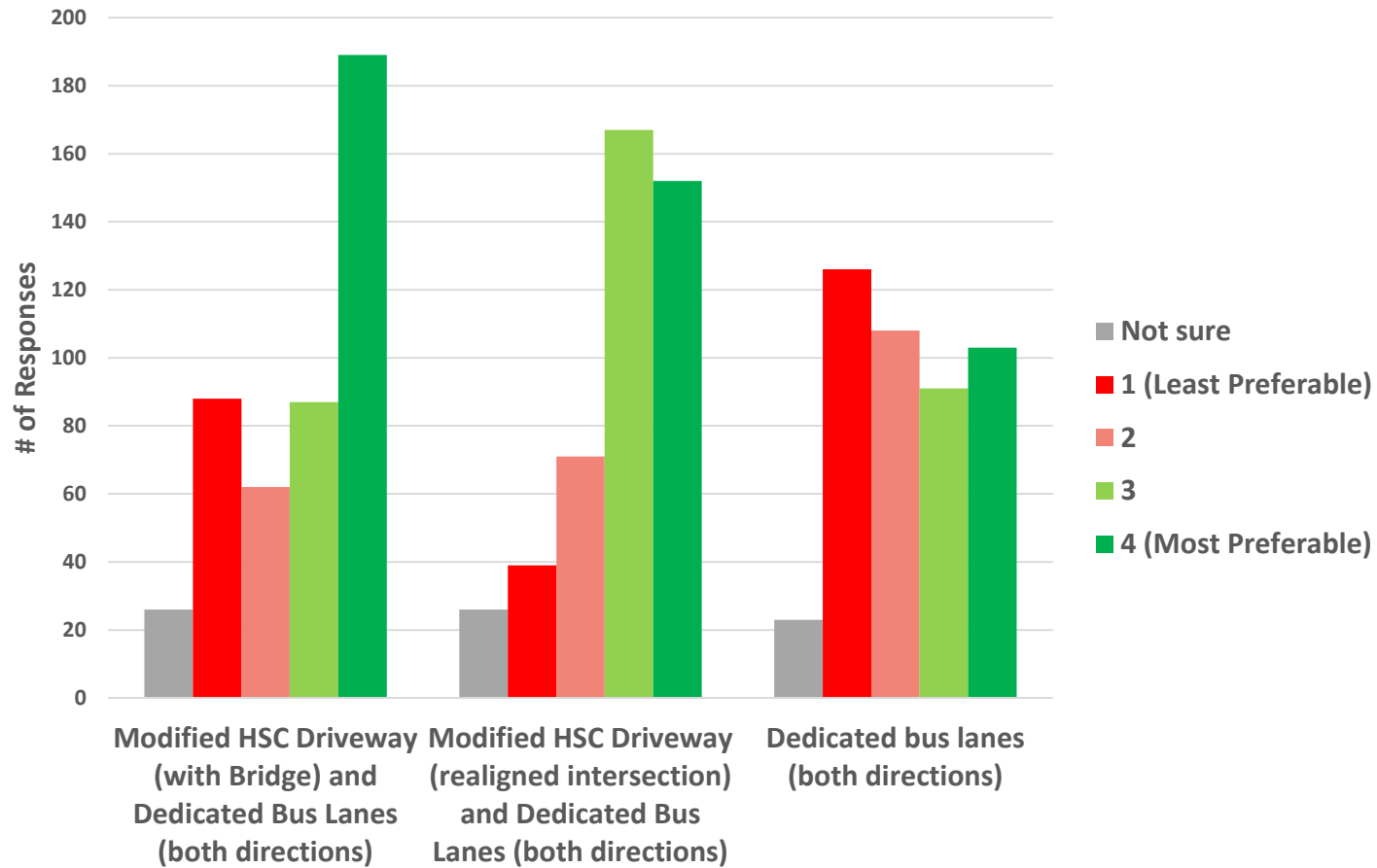

Bayers Road

Section 3 (Connaught Ave. to Connolly Street):
Indicate your preference based on the presented concepts

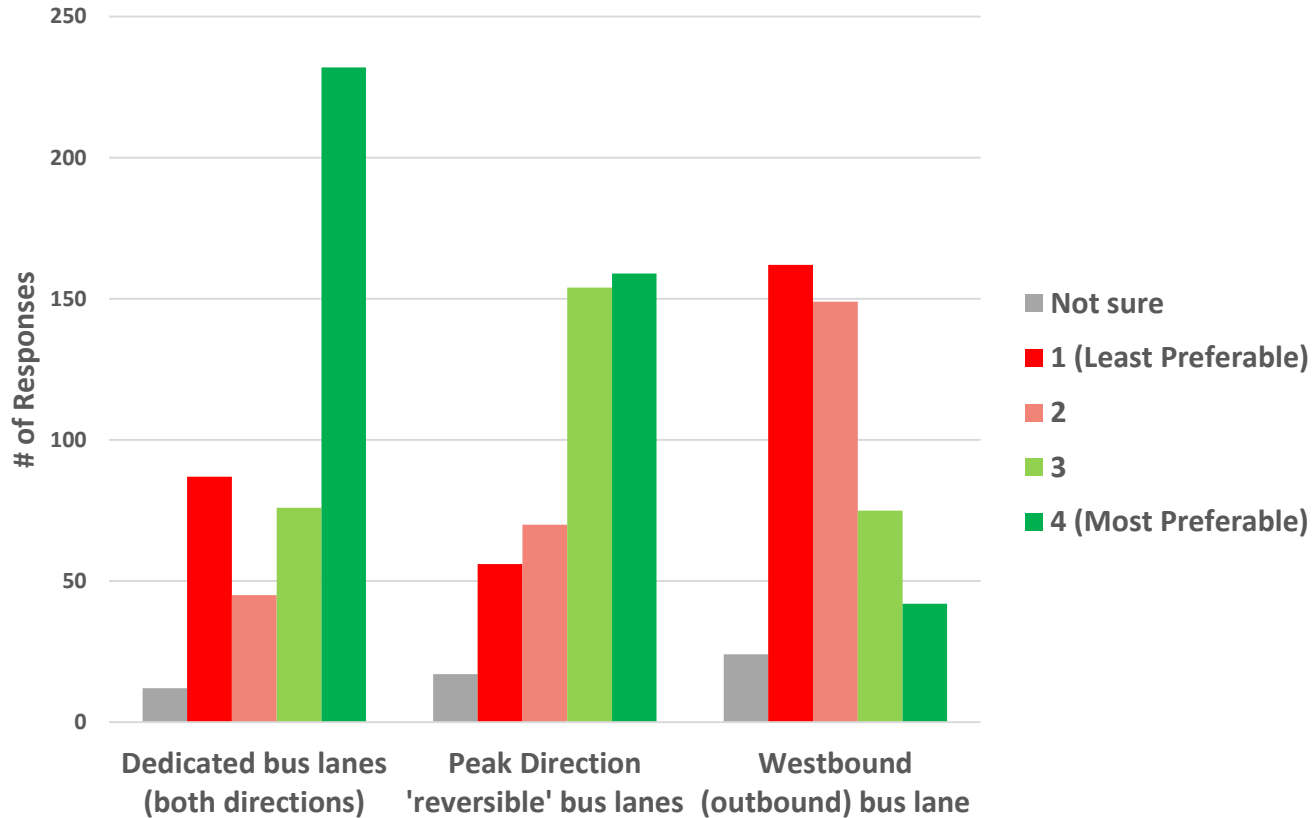

Bayers Road

Section 4 (Connolly Street to Windsor Street):
Indicate your preference based on the presented concepts

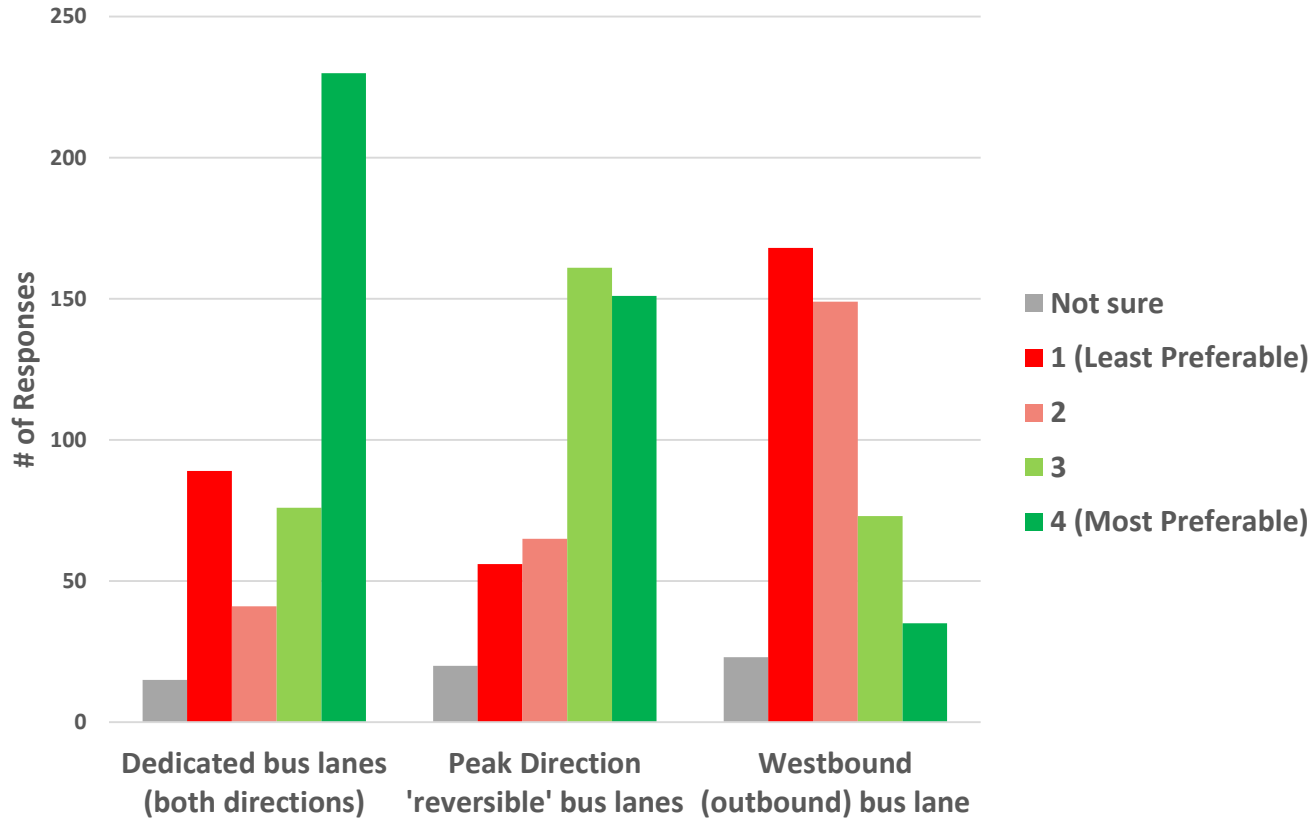

Gottingen Street

Shape Your City Online Survey	273
Paper Survey	23
Total Participants	296

Gottingen Street

How often do you use Gottingen Street?

of Responses

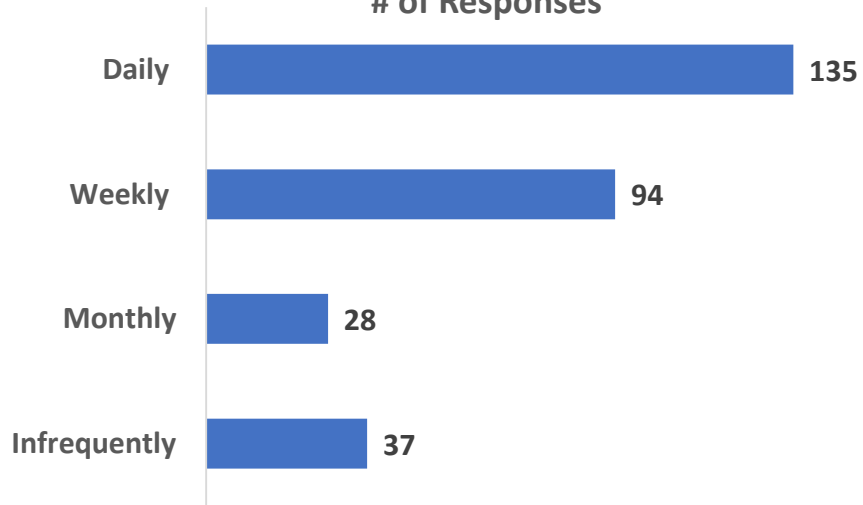

How do you usually travel on Gottingen Street?

of Responses

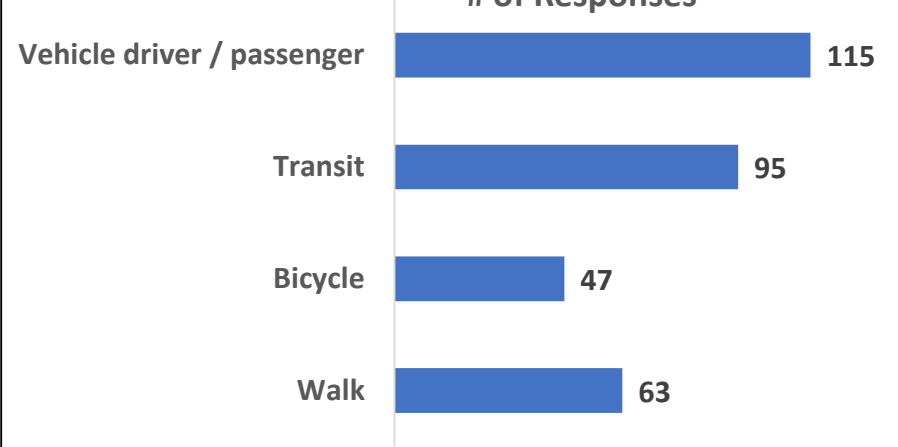

Gottingen Street

What matters most to you when you use Gottingen Street? (select up to 3)

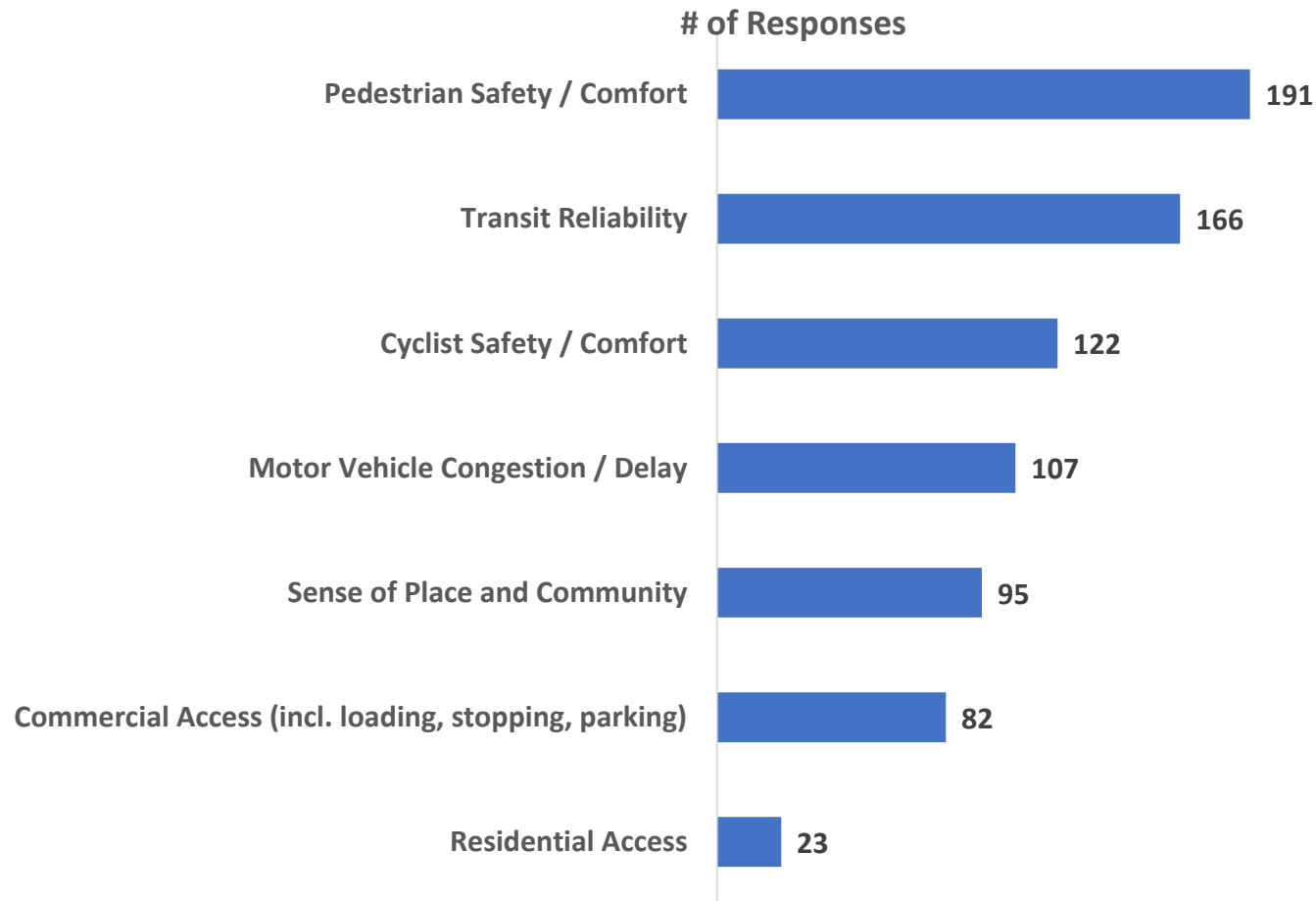

Gottingen Street

On a scale from 1-4 (where 1 is poor and four is excellent) how would you rate your experiences on Gottingen Street?

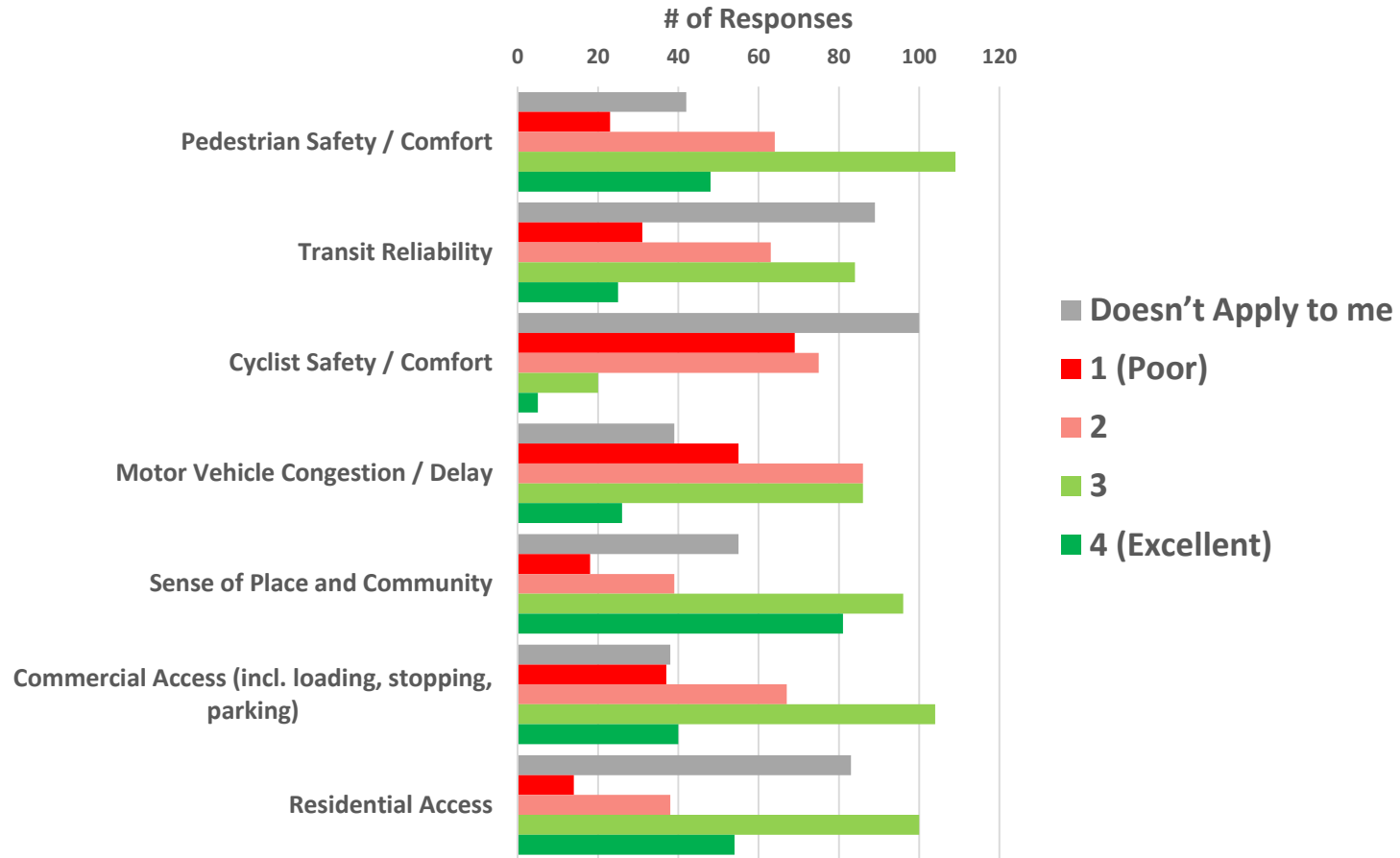

Gottingen Street

The addition of transit priority lanes on Gottingen Street may require trade-offs in some locations. How acceptable are the following potential trade-offs?

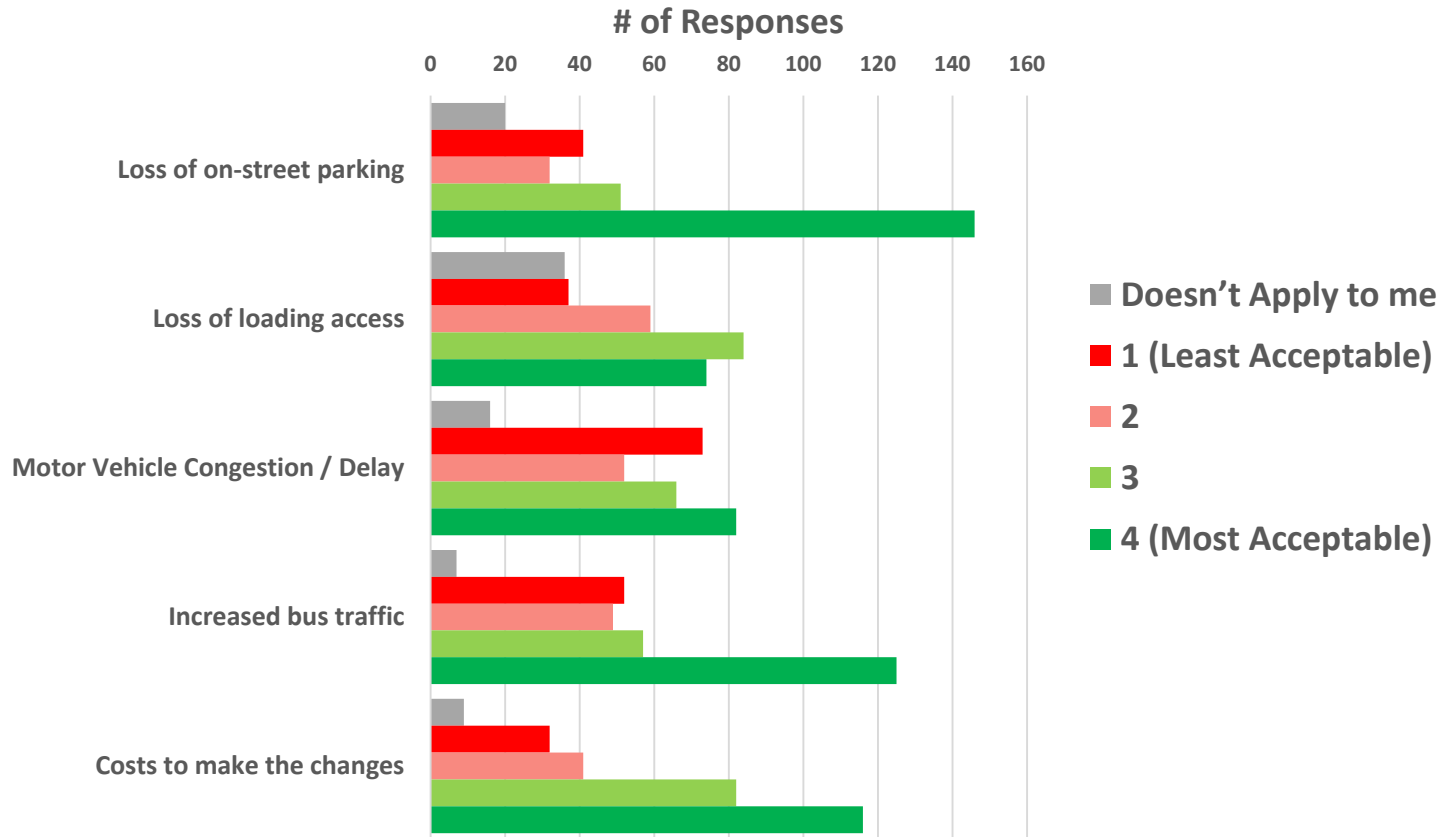

Gottingen Street

Section 1 (Cogswell Street to Cornwallis Street):
Indicate your preference based on the presented concepts

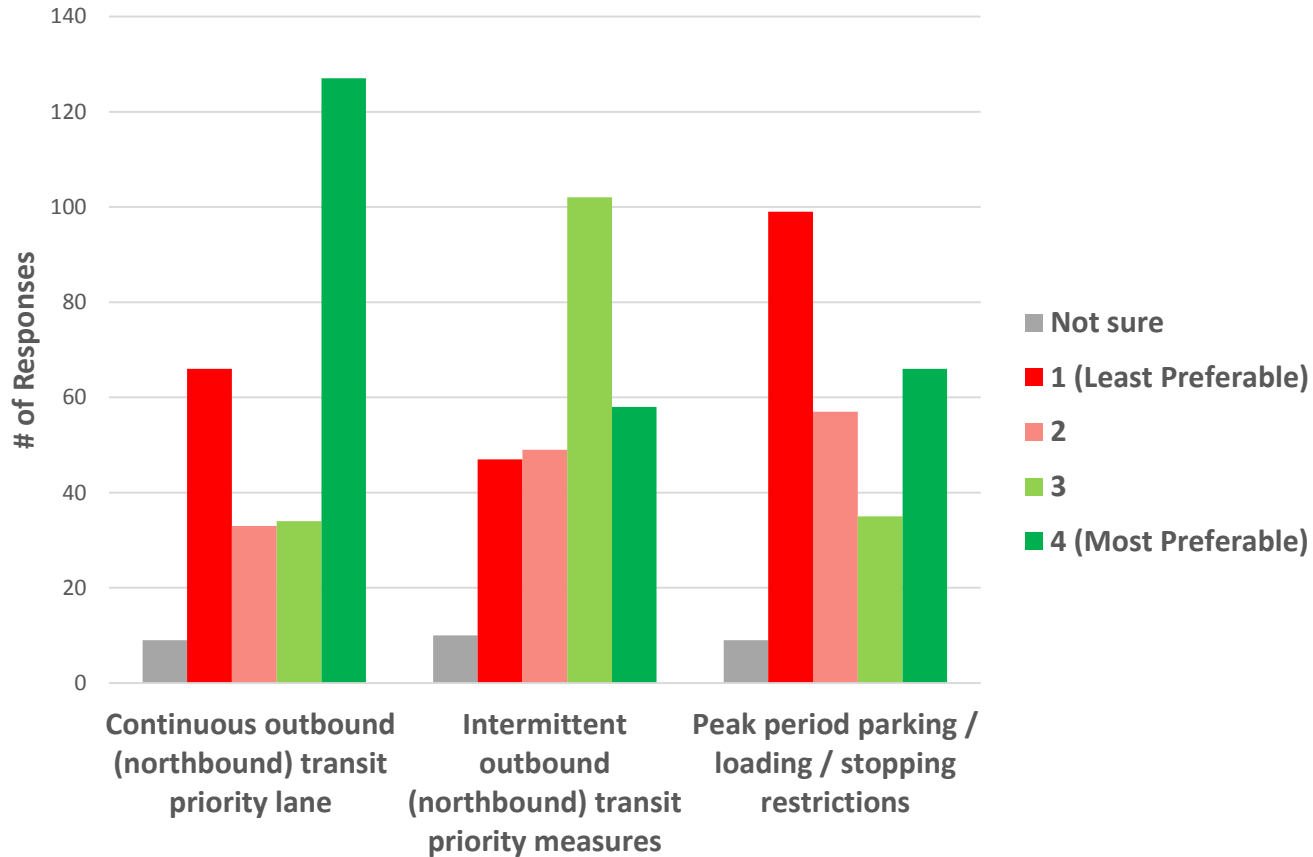

Gottingen Street

Section 2 (Cornwallis Street to Uniacke Street):
Indicate your preference based on the presented concepts

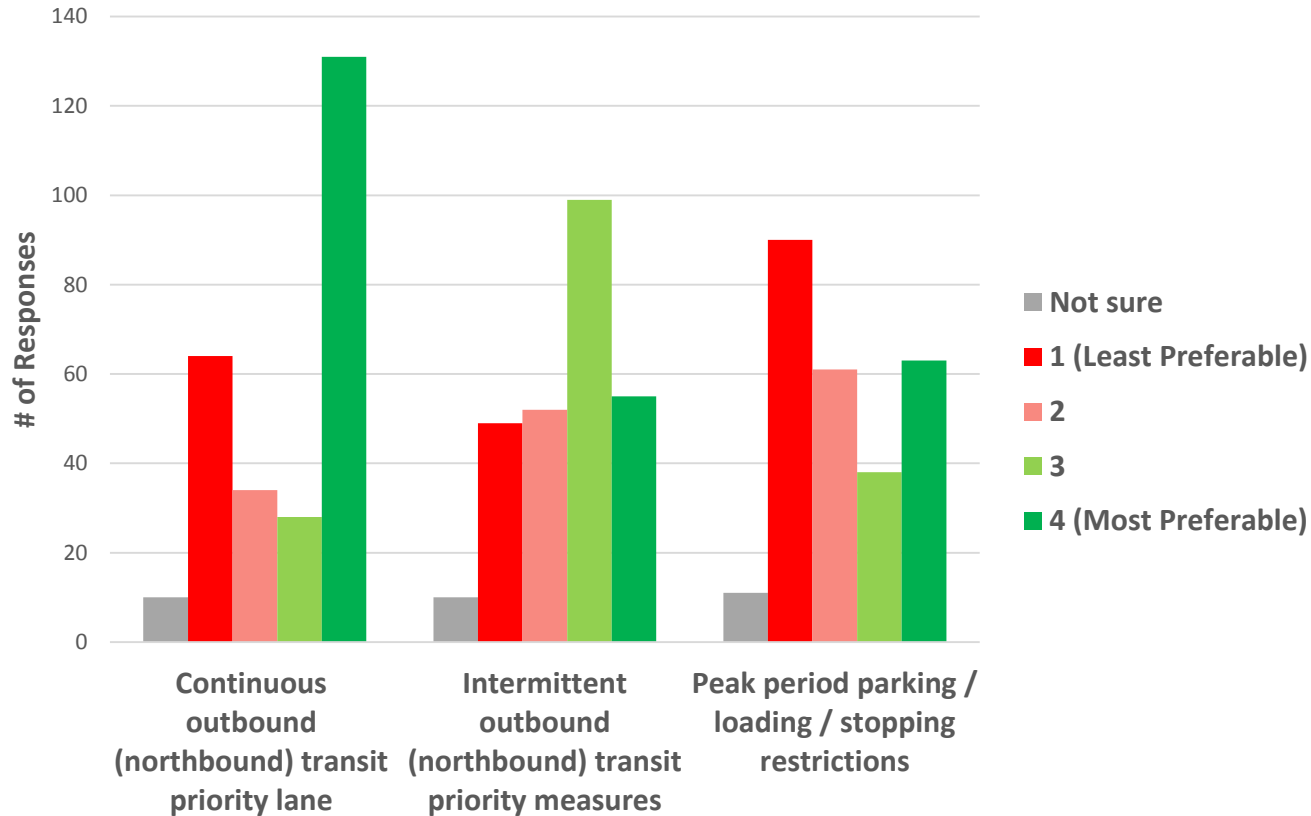

Gottingen Street

Section 3 (Uniacke Street to North Street):
Indicate your preference based on the presented concepts

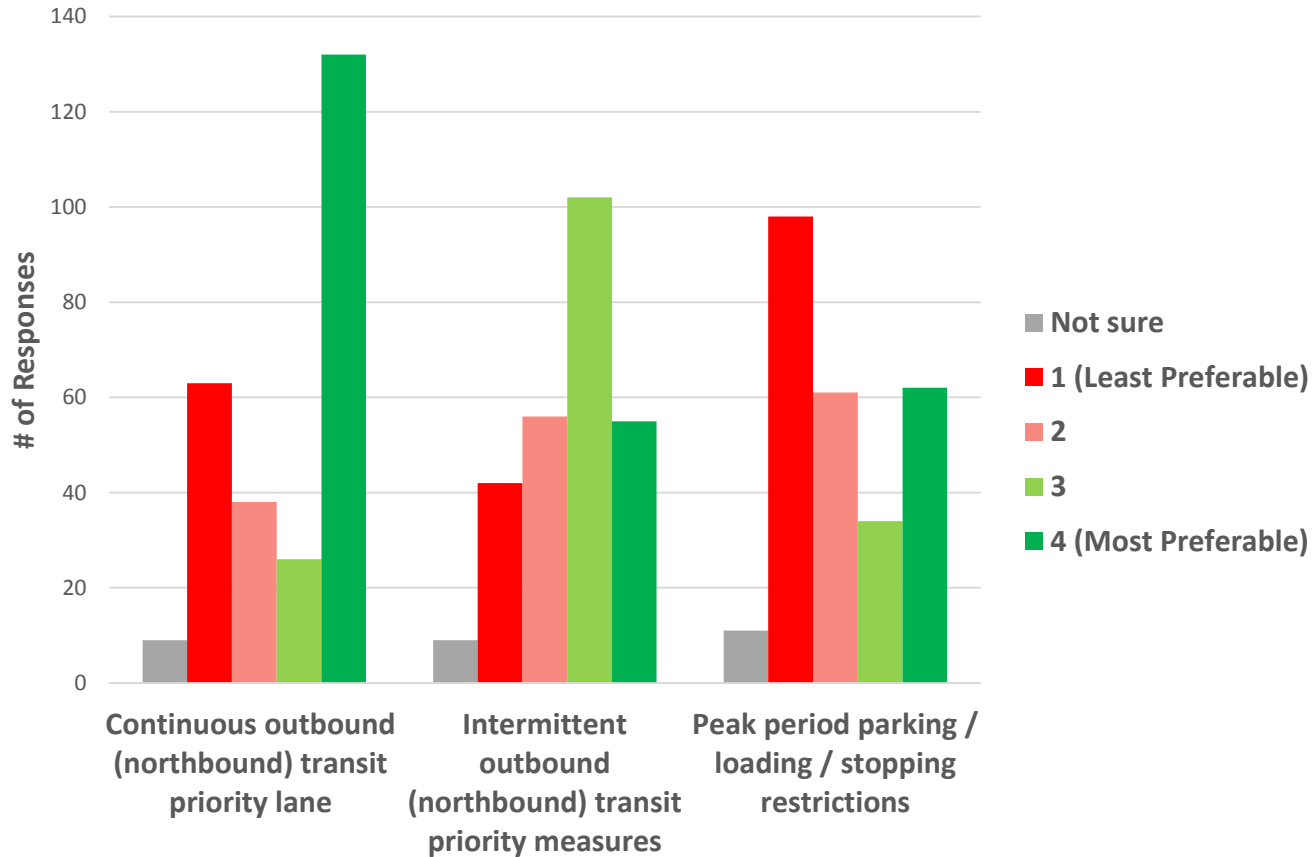

HALIFAX REGIONAL MUNICIPALITY

HALIFAX TRANSIT PRIORITY CORRIDORS – GOTTINGEN STREET AND BAYERS ROAD

JANUARY 2018



Project No. 171-09619



TABLE OF CONTENTS

1	INTRODUCTION AND BACKGROUND.....	1
1.1	Transit	1
1.2	Active Transportation (AT)	1
1.3	Study Area.....	2
1.4	Study Objectives.....	2
2	OVERVIEW OF EXISTING OPERATIONS	3
2.1	Traffic Congestion.....	3
2.2	Data Collection & Review	3
2.2.1	Topographic Survey and GIS data.....	3
2.2.2	Traffic Volumes.....	3
2.2.3	Transit Data	4
2.2.4	Pedestrians and Bicyclists.....	4
2.2.5	Parking.....	4
2.2.6	Road Safety	5
3	PROJECT APPROACH / FRAMEWORK	7
3.1	Design Objectives / Considerations.....	7
3.1.1	Design Workshop.....	7
3.2	Stakeholder & Community Consultation	9
3.2.1	HRM Internal Stakeholders.....	9
3.2.2	External Stakeholder Engagement.....	10
3.2.3	Public Open House	12
3.2.4	Online Consultation	12
3.3	Analysis Framework	13
3.3.1	Vehicular Impacts (Transit and non-transit).....	13
3.3.2	Multimodal Level of Service (MMLOS)	13
3.3.3	Parking / Loading	15
3.3.4	Road Safety	15
3.3.5	Cost Estimates.....	15
3.3.6	Overall Analysis.....	15
4	GOTTINGEN STREET.....	17
4.1	Existing Conditions	17
4.1.1	Existing Transit.....	18
4.1.2	Existing Traffic.....	18
4.1.3	Existing Multimodal Analysis.....	18
4.1.4	Road Safety	18
4.1.5	Existing Parking.....	18
4.2	Gottingen Street Modification Options	19
4.3	Gottingen Street Options Evaluation	20

5	BAYERS ROAD.....	23
5.1	Existing Conditions.....	23
5.1.1	Existing Transit.....	24
5.1.2	Existing Traffic.....	24
5.1.3	Existing Multimodal Analysis.....	25
5.1.4	Road Safety.....	25
5.1.5	Existing Parking.....	25
5.2	Bayers Road Modification Options.....	26
5.2.1	Romans Avenue to Halifax Shopping Centre.....	27
5.2.2	Halifax Shopping Centre (HSC) to Connaught Avenue.....	28
5.2.3	Connaught Avenue to Windsor Street.....	30
5.2.4	Windsor Street Intersection.....	32
5.3	Bayers Options Evaluation.....	33
6	SUMMARY & RECOMMENDATIONS.....	35
6.1	Summary.....	35
6.2	Recommendations.....	36
6.2.1	Recommendations - Gottingen Street.....	36
6.2.2	Recommendations - Bayers Road.....	37

APPENDICES

A	FUNCTIONAL DESIGNS
B	PUBLIC CONSULTATION FEEDBACK FORMS
C	ONLINE CONSULTATION RESULTS
D	COST ESTIMATES
E	SAMPLE DELAY AND PAYBACK CALCULATIONS
F	GOTTINGEN STREET INTERSECTION CAPACITY ANALYSIS
G	BAYERS ROAD INTERSECTION CAPACITY ANALYSIS

1 INTRODUCTION AND BACKGROUND

1.1 TRANSIT

Recent and ongoing policy development efforts have made improvements to Halifax’s transit service a key priority for the Municipality. Specifically, Halifax Transit’s *Moving Forward Together Plan* (adopted by Regional Council in April 2016) includes bold moves that aim to improve transit service levels through increased priority, enhanced reliability, and reduced travel time. The bold moves are being made in support of the following four Council-endorsed ‘*Moving Forward Principles*’:

1. Increase the proportion of resources allocated towards high ridership services.
2. Build a simplified transfer based system.
3. Invest in service quality and reliability.
4. Give transit increased priority in the transportation network.



Among the key initiatives that the Municipality is considering for transit upgrades are Transit Priority Measures (TPMs) – strategically located street and intersection upgrades that provide priority for the movement of buses. TPMs provide opportunities to make notable improvements to transit operation, and can be particularly effective in locations where right-of-way (ROW) constraints limit the ability to implement more dedicated facility options. When used effectively, TPMs can provide significant network benefits to transit operation that can stem from time savings of as little as a few seconds at a time.

Building on HRM’s recent success of implementing TPMs at various locations, the Municipality is interested in investigating corridor-level transit priority upgrades that satisfy specific recommendations of the *Moving Forward Together Plan* including two “critical locations” that were identified for transit priority measures: **Bayers Road** and **Gottingen Street**. In particular it has indicated an “urgent need for Transit Priority Measures in the Bayers Road corridor in order to provide reliable service to transit users.”

1.2 ACTIVE TRANSPORTATION (AT)

Active Transportation Connection Study (WSP, 2016) identified alternatives for a multi-use AT facility that would provide a formal connection between the COLT (at Joseph Howe Drive) and George Dauphinee Avenue. That report recommended an offstreet AT greenway on the south side of Bayers Road be provided but identified complications with right-of-way requirements and the signalized crossings of the Halifax Shopping Centre Driveways.

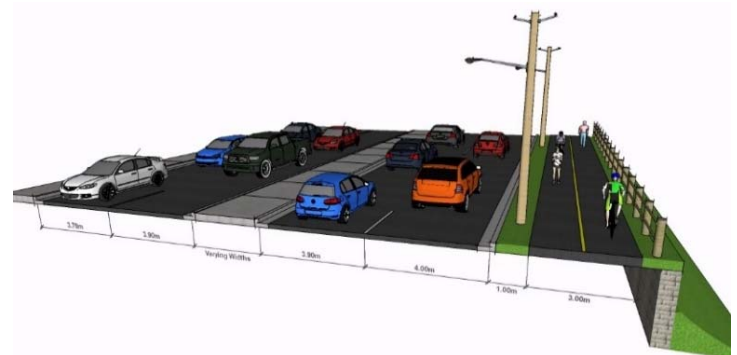

At the outset of this current study, HRM staff requested that consideration of an offstreet greenway south of Bayers Road between the study limits at Romans Avenue and George Dauphinee Avenue be included in the functional designs for all options through this segment.

1.3 STUDY AREA

The Study Area for this project includes the following corridors (shown in Figure 1-1):

1. Gottingen Street: North Street to Cogswell Street; and,
2. Bayers Road: Romans Avenue to Windsor Street.

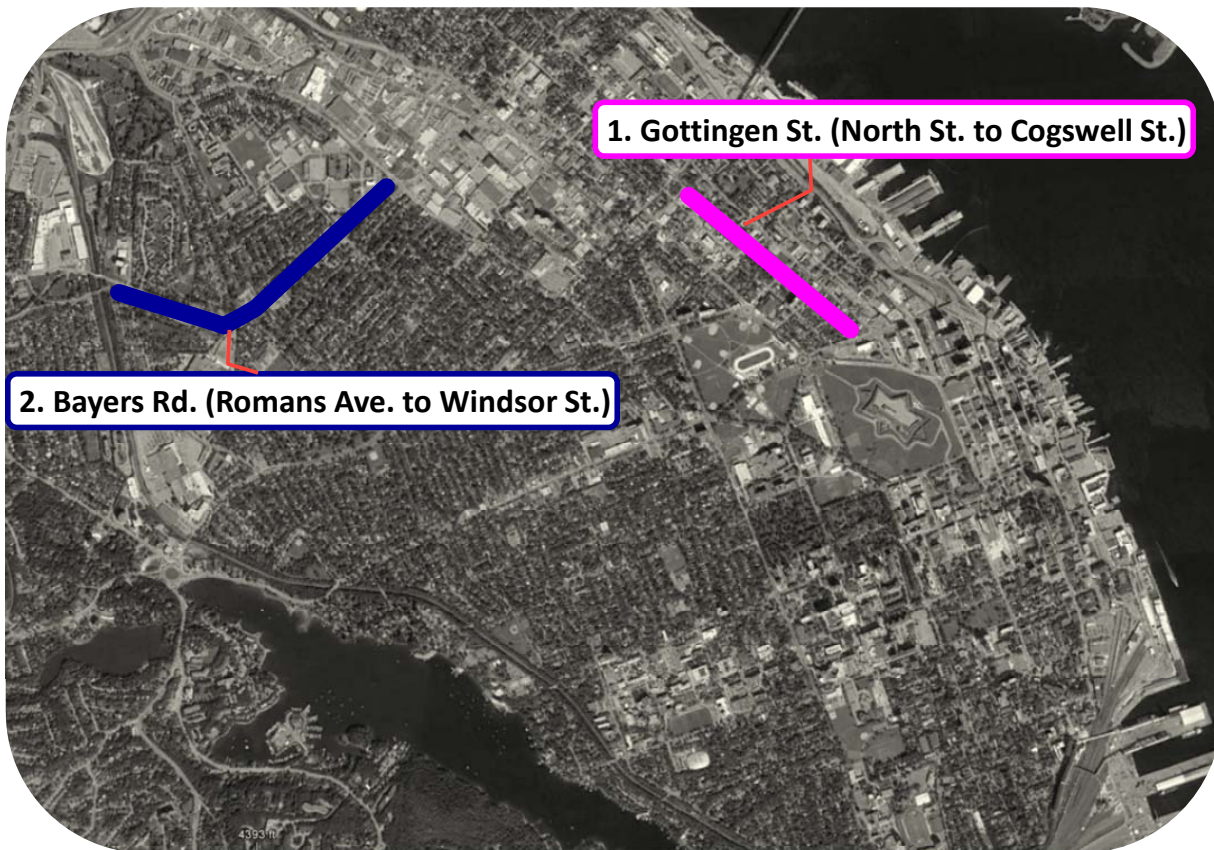

Figure 1-1 – Study Area Corridors

1.4 STUDY OBJECTIVES

The primary goal of this assignment is to develop and evaluate functional design options for transit priority along the study area corridors. Specific project objectives include:

1. Complete a detailed investigation of existing conditions within the Study Areas, including topographic survey and establishment of the functional operations of each street (i.e. traffic operation, transit delay, parking, loading, etc.);
2. Develop an understanding of existing and projected multimodal transportation demands;
3. Prepare functional design options and Class D Cost Estimates for each proposed option along each transit priority corridor;
4. Engage with key HRM internal stakeholders, external stakeholders, and the general public to identify the relevant constraints and obtain feedback on design options;
5. Complete assessments for each of the functional design options that focus on transit operational benefits, intersection performance, parking / curb access, and road safety considerations;
6. Prepare a design report that documents background information, summarizes key design assumptions and rationale, and provides comparative evaluation for each option.

2 OVERVIEW OF EXISTING OPERATIONS

2.1 TRAFFIC CONGESTION

Traffic congestion along the considered corridors has become an increasing concern in recent years. Long delays and queues have been observed throughout the study area, particularly westbound on Bayers Road during the PM peak period where travel times for traffic between Windsor Street and Connaught Avenue (a distance of approximately 800 metres) have been observed to exceed 15 minutes on a typical weekday. These long queues and high delays have led to shortcutting concerns in several adjacent residential neighbourhoods.

Moving Forward Together Plan (Halifax Transit, 2016) identifies the congestion on Bayers Road as a particular concern and recommends rerouting Transit Route #1 (Spring Garden) onto Roslyn Road, a local street, during the PM peak period “in order to maintain schedule adherence”.

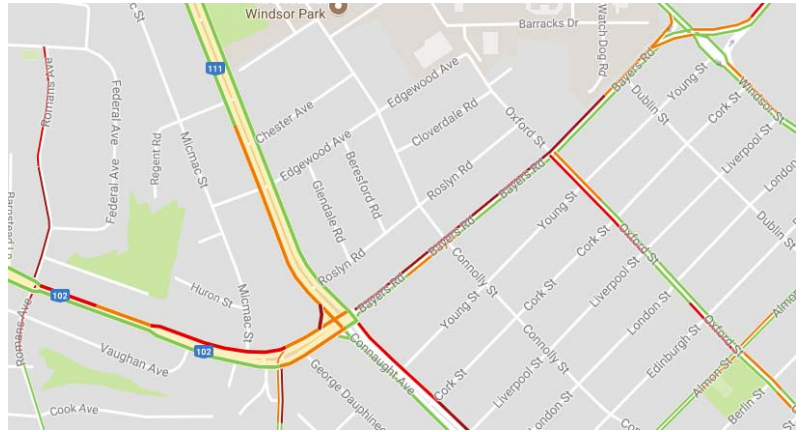

Figure 2-1 – Google Traffic Maps: 4:30 PM, Tuesday October 17, 2017

2.2 DATA COLLECTION & REVIEW

Significant data were collected at the outset of the project to develop an understanding of the existing topographic and traffic, transit, and active transportation demand along the considered corridors. The below sections summarize the methodology and results of this data collection.

2.2.1 TOPOGRAPHIC SURVEY AND GIS DATA

WSP’s survey team conducted a detailed topographic survey of the existing terrain of the corridors through the Study Area including the approach streets and abutting properties. The survey located, using real world coordinates, all relevant existing infrastructure including general site grades, curbs, power / communications systems, trees, and any other features that may affect the proposed designs. The data were imported into AutoCAD drawings for use as the topographic base for the design exercise.

The topographic field survey has been supplemented with HRM supplied GIS data and aerial imagery to identify the property boundaries and HRM right-of-way limits within the study area.

2.2.2 TRAFFIC VOLUMES

Intersection turning movement counts (collected between 2014 and 2016) and existing traffic signal timings for key study area intersections were provided by HRM Traffic Management for use in the review of existing traffic characteristics and analysis of intersection performance. HRM Traffic Management also provided historical 24-hour machine counts along each corridor for consideration of historical and anticipated growth trends.

GROWTH TRENDS

Traffic volumes collected by HRM along each corridor were analyzed in order to develop an understanding of traffic growth trends. Results (See Figure 2-2) do not indicate a clear growth trend for traffic volumes on study area routes.

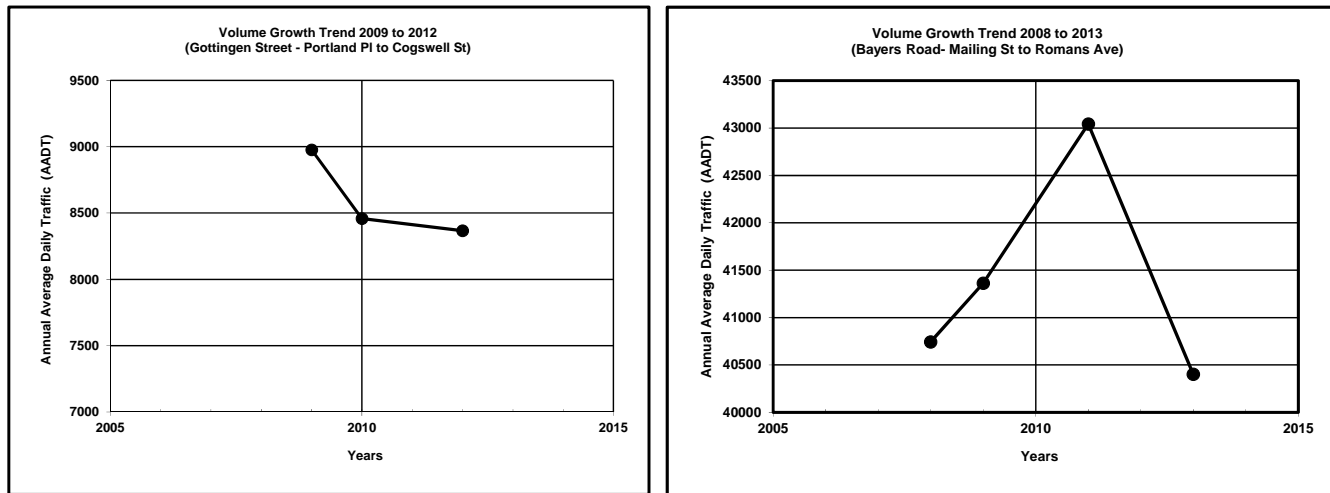

Figure 2-2 – Traffic Volume Growth Rates – Gottingen Street and Bayers Road

DESIGN HOURLY VOLUMES

Design hourly volumes were developed using the intersection turning movement count data collected by HRM Traffic Management. Based on a comparison of the count data with historical turning movement and machine count data (also provided by HRM), the intersection count data appear to be representative of typical conditions.

Given the lack of a clear historical trend of volume growth along these routes, the design hourly volumes have been estimated using the observed AM and PM peak hour volumes with no additional growth factors. Increased growth of traffic volumes would increase congestion in the analysis, increasing the need for transit priority.

2.2.3 TRANSIT DATA

Transit vehicle volumes and ridership data were provided by Halifax Transit for each existing transit route within the study area. No growth factor has been applied to the transit ridership or bus volume data. Additional transit travel time data were provided by Halifax Transit for buses along Gottingen Street.

Since there is some uncertainty of planned frequency for some of the future routes identified in *Moving Forward Together Plan* (Halifax Transit, 2016) and because ridership forecasts for these routes were not available for this project, transit vehicle and ridership volumes for existing routing were used in the analysis. It is recognized that each of the study area roads have been identified by Halifax Regional Council as Transit Priority Corridors and it expected that transit ridership and bus volumes will likely increase, particularly with the implementation of corridor level transit priority measures.

2.2.4 PEDESTRIANS AND BICYCLISTS

Available pedestrian and bicycle volume data for the study area were provided by HRM Traffic Management.

2.2.5 PARKING

Field investigation was completed by WSP to inventory the location of existing parking along each of the studied corridors. Data on parking utilization were not available.

2.2.6 ROAD SAFETY



Road safety is an important component of any design, including transit facilities. A literature review of available road safety research was completed for this project to consider the collision history along different types of transit facilities. In conducting the review, several studies were found that provided collision data for different types of transit facilities, however, no such studies were found that provided reliable data within the Canadian or American context. Most of the available research used data from Mexico, South America, India, and Australia.

Sources:

<http://www.wrirosscities.org/sites/default/files/Traffic-Safety-Bus-Priority-Corridors-BRT-EMBARQ-World-Resources-Institute.pdf>

<http://trrjournalonline.trb.org/doi/pdf/10.3141/2402-02>

There are several types of lanes in Canada that are used by transit. The most common types are summarized below:

Transit Lane Type	Description	Results of Literature Safety Review
Mixed Traffic	Transit vehicles travel in mixed use lanes and navigate congestion with other road users. This is considered the baseline scenario and represents the existing conditions on study area streets.	
Curbside Bus Lanes	The curb lane can be designated as a transit lane for the same travel direction. 	The conversion of conventional bus service to bus priority with queue jump lanes and transit signal priority was found to reduce total collisions in Melbourne, Australia by 11% while injury collisions were reduced by 25%. http://www.wrirosscities.org/sites/default/files/Traffic-Safety-Bus-Priority-Corridors-BRT-EMBARQ-World-Resources-Institute.pdf
Median Bus Lanes	 Median bus lanes provide a designated transit lane in the centre of the street. Stops are provided at specific points and left turns are only permitted at signalized intersections with protected only phases, eliminating transit conflict with turning vehicles.	The literature review identified several projects where median bus lanes offered significant safety benefits overall when compared to other transit facility types, due to reduced vehicle conflict points with vehicles. Although benefits may be realized, careful consideration of left turns and pedestrian crossings and overall road width are required.

This Space Intentionally Left Blank

3 PROJECT APPROACH / FRAMEWORK

3.1 DESIGN OBJECTIVES / CONSIDERATIONS

The design objective for this project is to provide priority for transit along each corridor while also considering active transportation, traffic operations (including heavy vehicles) as well as the impact to parking and adjacent properties. The considerations are summarized in Table 3-1.

Table 3-1 - Project Considerations

Factor	Evaluation Considerations
Halifax Transit	Efficient movement of buses through the study corridors is a key consideration of this project. Design options have reviewed the ability of buses to navigate through the intersections and along the corridors with consideration given to the estimated and observed delays under existing conditions and the potential to improve transit operation through transit priority.
Active Transportation (Pedestrians / Cyclists)	Accommodation of active transportation is very important to HRM and the provision of sidewalks and safe street crossings is an important consideration. Bayers Road in particular has been identified as a candidate for an active transportation greenway in the HRM AT plan. Evaluation of each design option based on pedestrian and cyclist accommodation will focus on the extent to which key inputs such as pedestrian / cyclist exposure to vehicular traffic (i.e. crossing distances) are expected to change with implementation of each option.
Vehicular Traffic	Both Bayers Road and Gottingen Street in the project study area are classified as arterial streets with Bayers Road serving as a key truck route to Peninsular Halifax. Ideally, vehicular capacity should remain consistent with existing conditions. The approach to assessment of impacts to vehicular traffic includes performance analysis of the intersections and the corridors under consideration. Intersection performance analysis, completed using Synchro / SimTraffic is the basis upon which intersection capacity requirements (i.e. lane configurations, # of lanes) are determined. Comparison of results among the design alternatives enables understanding of the impact that each has on vehicular traffic performance.
Parking / Loading	The available parking and loading has been identified along the study area corridors. Impacts to parking and loading have been considered in the analysis.
Right-of-Way Impacts	Consideration has been given to the impacts of roadway expansion. Where available, properties already owned by HRM were considered first and where necessary, property acquisition has been identified. Other impacts on adjacent properties (i.e. grading) were also considered in the options analysis.

3.1.1 DESIGN WORKSHOP

A Functional Design Workshop was held early in the design phase with HRM staff to discuss innovative, yet feasible options for transit priority measures along each corridor. A discussion on prioritization within a transit priority corridor began the workshop. Although it was recognized that precise priorities for each corridor and section of each corridor is highly context sensitive, the group came to a consensus that right-of-way prioritization for the transit corridors were be as follows:

- | | |
|-----------------|-----------------------------------|
| Higher Priority | 1. Sidewalk |
| ↓ | 2. Transit and transit stops |
| | 3. Non-Transit Traffic |
| | 4. Deliveries and Loading |
| | 5. Parking (Vehicular / Bicycles) |
| | Lower Priority |

Throughout the workshop, the group discussed design options for sections and key intersection along each of the corridors. The following is a summary of key highlights:

GOTTINGEN STREET

- Gottingen Street has a number of challenges including limited right-of-way and a number of uses that compete for space (e.g. on-street parking and loading, traffic, transit, cyclists, pedestrians).
- Options for traffic divergence to adjacent streets (i.e. one way on Gottingen Street) were discussed however there were concerns with having an increase of traffic on adjacent local streets.
- Removing on-street parking during peak hours were discussed and should be considered in the functional design options.
- Options for how to make Gottingen Street a transit priority corridor must be well thought out. It is highly used by pedestrians with currently limited sidewalk space, it has an active business community and is a dense residential community directly on and adjacent to the corridor. Existing built forms have little to no setbacks off of Gottingen Street which makes road widening not feasible.

BAYERS ROAD: ROMANS AVENUE TO CONNAUGHT AVENUE

- Agreement that two curbside transit lanes (one in each direction) should be considered. This option however, would require widening of the right-of-way.

BAYERS ROAD: HALIFAX SHOPPING CENTRE AND CONNAUGHT AVENUE INTERSECTIONS

- This section was identified as a significant challenge along the corridor. The two intersections are closely spaced together and result in traffic queues from all approaching directions during peak times.
- HRM owns property to the north (between the two intersections) which could be incorporated to alleviate traffic congestion in this area.
- Design options ranging in level of investment were discussed and included building an overpass across the HRM owned property (high investment), to realigning lanes and signals timing (low investment).

BAYERS ROAD: CONNAUGHT AVENUE TO WINDSOR STREET

- Two full-time transit lanes along this segment should be considered that would require a high level of investment.
- Currently, there are high transit volumes traveling on this segment of the corridor, so a high investment option may be worth implementing.
- Having bi-directional bus-only lanes may require road widening and elimination of a west-bound traffic lane.
- Other options requiring lower levels of investment (and lower impacts to adjacent residential properties) will need to be considered.

BAYERS ROAD: BAYERS ROAD/ YOUNG STREET/ & WINDSOR STREET INTERSECTION

- Options for a roundabout were discussed, however it is difficult to incorporate a bus-only lane with this design option.
- Other options must be considered that would involve bus-only transit lanes to travel through the intersection efficiently.

3.2 STAKEHOLDER & COMMUNITY CONSULTATION

One of the key aspects of this project was the consultation with stakeholders and the public at large. Separate meetings were held with HRM staff, stakeholder groups external to the municipality, and with the public through Open House style meetings.

3.2.1 HRM INTERNAL STAKEHOLDERS

A meeting was held with HRM Internal staff who provided insight in various areas of expertise related to TPM on the identified corridors. Attendees represented the following areas of interest and expertise:

- Strategic Transportation Planning
- Traffic Management
- Parking Management
- Halifax Transit
- Streetscaping and Active Transportation
- Planning and Development
- Urban Forestry
- Cogswell Redevelopment Project

The following is a summary of what we heard from HRM staff:

GOTTINGEN STREET

- Currently, the congestion of buses during PM peak periods spills over on to Cogswell Street. Need to consider how to improve this situation.
- The Macdonald Bridge bikeway overpass will change the intersection alignment at Gottingen Street and North Street.
- Existing off-street paid parking on the corridor will be used for development (making it unavailable for public parking in the future). A parking analysis will need to be done prior to any decisions being made.
- Parking for local businesses will be of concern. Want to try to make sure we don't have a net loss of parking in the area. If spaces on Gottingen Street are removed, where will they be replaced? Adjacent side streets?
- If higher order bus stops are being planned, consider the setbacks needed for them. The right of way is pretty tight as it is.

BAYERS ROAD

- There is currently a plan to implement a 3 metre multi-purpose trail for Active Transportation between Vaughan Ave. and George Dauphinee Ave.
- Currently, streetscaping along the west end of Bayers Road is not conducive to pedestrian use. Vaughan Ave. is a more pleasant walk for pedestrians as it is (quieter, safer, and less stressful).
- The forthcoming Centre Plan has policy outlining the importance of developing on corridors and identifies that greater front yard setbacks on new developments will be required. These setbacks will reflect the likely need for the Municipality to acquire land in the future.
- Staff identified there is an opportunity for **alignment of Transit Priority Measures with the Centre Plan.**
- Must consider the impact of trees, (individual stands as well as on the mix of species in an area) along the corridor. There are large elms on Bayers Road before Connaught Ave.
 - Also need to consider how to build projects in the city and still achieve the goals set in the Urban Forest Master Plan. If trees need to be removed, can more be planted elsewhere (i.e. on other parts of the right-of-way or on private property)?
- On-street parking may be an issue on the east end of the corridor.
- A particularly challenging issue will be between the Halifax Shopping Centre and Connaught Ave. Should look at traffic numbers coming to and from the Halifax Shopping Centre.

3.2.2 EXTERNAL STAKEHOLDER ENGAGEMENT

Separate meetings with stakeholders external to municipal staff were also held. Project information and consultation meetings were held with the Halifax Utility Coordinating Committee (HUCC), the North End Business Association (NEBA), and various community advocacy groups. The following is a summary of feedback provided from each of the external stakeholder meetings.

HALIFAX UTILITY COORDINATING COMMITTEE (HUCC)

- Prior to any construction, HUCC members will need to know whether or not utility relocation is required.
- A change in curbs will be their biggest concern. These will have impacts of where their services are located.
- Currently the right-of-way on Gottingen Street is very tight. Relocation will be costly.
- Bayers Road: Bell Aliant has a major cross-section of cable routes along this corridor. If this cross section had to be moved, it would be very costly and time consuming.
- Will federal infrastructure money help pay for the costs to relocate utilities?

NORTH END BUSINESS ASSOCIATION (NEBA)

- Highly concerned about having Gottingen Street designated as a TPM corridor.
- Having on-street parking and loading available for businesses is essential for commercial viability.
- Currently, the buses on Gottingen Street are loud and noisy. If more buses travel on Gottingen Street, NEBA felt this will worsen these negative impacts and degrade the street's public realm.
- During non-peak periods, members of NEBA indicated that few passengers are actually on the buses that travel down Gottingen Street. NEBA members asked how Halifax Transit can make their routing more efficient/more effective for moving people without having under-utilized buses travel the corridor?
- The Link and express buses turn Gottingen Street into a “bus highway”. NEBA indicated that the community doesn't want buses traveling through the corridor if they're not actually serving the immediate community.
- NEBA felt that buses (especially Link or express routes), should be using Barrington Street to move north. NEBA asked Halifax Transit to work with the Bridge Commission to fix the geometry of the ramp to the Macdonald Bridge so that buses can be accommodated and re-routed from Gottingen Street.
- NEBA felt that putting more buses on the corridor will negatively impact businesses on Gottingen St. Members indicated that it has taken years to bring life and vibrancy back onto the street.
- Attention should be given to the crosswalk at Gottingen Street & Buddy Daye Street. This is frequently used (by children) and doesn't have great visibility to drivers.

COMMUNITY ADVOCACY GROUPS

Members from community advocacy groups came together for a project introduction and consultation meeting. The following groups were represented at this meeting:

- Walk n Roll
- Halifax Cycling Coalition
- DalTrac
- It's More than Buses
- Canadian National Institute for the Blind (CNIB)

The following is a summary of what was heard:

GOTTINGEN STREET

- Similar concerns were voiced from community group representatives that had been heard from the NEBA meeting: noise and pollution impacts, should avoid turning Gottingen into a “bus highway”, concerns about the impacts of removing on-street parking for local businesses.
- Consider using TPM treatments on Gottingen Street to “brand” transit priority. I.e. consider colouring the pavement for the bus only lanes.
- The bike ramp off of the Macdonald Bridge will impact how cyclists use Gottingen Street. Coming off the bridge, using Gottingen Street seems to be a natural transition. However currently, the IMP has Brunswick as the dedicated cycling route. Does this make sense?
- The topic of making Gottingen Street a bus/pedestrian/cyclist only corridor (e.g. no cars permitted) was discussed. This option could have the potential of improving the public realm by implementing bicycle infrastructure, widening sidewalks, as well as giving transit the space it needs to move through effectively.
- Similar to Bayers Road, HRM needs to consider accessibility planning. For the visually impaired, it is much easier to delineate the sidewalk and roadway when there is landscaping/grass between the curb and the walking area. Audible bus stops are also recommended to accommodate the visually impaired.
- How will TPM impact cyclists? Need to make sure these measures are not to their detriment.

BAYERS ROAD

- Community Group representatives felt that there is a difference between this proposal for road widening, and the one that happened 8-10 years ago on Bayers Road. If road widening is happening to bring more buses on the road (and not cars), there will likely be less resistance and more acceptance to the project.
- Community Group representatives suggested HRM should consider congestion pricing – tax personal motor vehicles going into the peninsula. This will be easier (and less money) than doing road widening.
- Representatives indicated that this is an opportunity to turn Bayers Road into a true Complete Street. It is currently in desperate need for a pedestrian and cycling realm improvement. Bayers Road could be the “poster child” for Halifax’s complete streets.
- HRM needs to consider accessibility planning: consider sidewalk access, audible bus stops, grades, etc.

3.2.3 PUBLIC OPEN HOUSE

Two open houses, (one focused on Bayers Road, and the other focused on Gottingen Street), were held for members of the public to review the proposed functional design options along each of the two corridors. Using panel displays, residents were shown design options for segments of the corridor ranging from high investment (giving transit greatest priority), medium investment, and low investment (giving transit minimal priority). With each design option, a summary of user impacts were provided as well as an overview of pros and cons should the design be implemented. Residents were asked to provide their feedback and indicate which of the design options they prefer (if any at all). Copies of the public open house boards for both Gottingen Street and Bayers Road are included in Appendix A while comment feedback for each are presented in Appendix B.



Photo 1 - Gottingen Street Open House - October 2, 2017



Photo 2 - Bayers Road Open House - September 28, 2017

3.2.4 ONLINE CONSULTATION

An online survey was commissioned by the HRM project team to gather further public input on the display boards (Appendix A) and made available on the project's Shape Your City website. Paper copies of the survey were also made available at each of the two Open Houses. Results of the survey have been generated by HRM staff and have been presented in Appendix C.

The following are key highlights from the online survey for each of the two corridors:

GOTTINGEN STREET, n = 296

- Forty percent of survey participants travelled the corridor in a personal motor vehicle. Sixty percent travelled through on transit, bicycle, or as a pedestrian.
- Pedestrian safety and comfort was the most important issue that mattered to survey participants with over half indicating their current experience with pedestrian safety and comfort were good or excellent.
- Loss of on-street parking was the most acceptable trade-off with the addition of a transit-only lane. Motor vehicle congestion or delay was the least acceptable.
- For all corridor sections, the High Investment option was identified as the most favourable among survey participants.

BAYERS ROAD, n = 488

- Over half of respondents usually travelled through the corridor in a personal motor vehicle (as a driver or as a passenger).
- Transit reliability was the most important issue that mattered to survey participants and over half indicated their current experience with transit schedules were considered poor.
- Loss of on-street parking was the most acceptable trade-off with the addition of a transit-only lane while increase of motor vehicle congestion or delay was the least acceptable.
- For all corridor segments, the High Investment option was the most favourable among survey participants.

3.3 ANALYSIS FRAMEWORK

The analysis of each option includes consideration of impacts on Transit Operations, Multimodal Level of Service, Traffic, Parking/Loading, and Property Impacts. The analysis framework for each of these considerations is described in the subsequent sections.

3.3.1 VEHICULAR IMPACTS (TRANSIT AND NON-TRANSIT)

In *Halifax Transit Priority Measures Study* (WSP, 2016) an analysis framework was developed to consider the costs and benefits to transit and the overall public of a given transit priority measure. That methodology has since been included as Appendix E in *Moving Forward Together Plan* (Halifax Transit, 2016) as the methodology used for the evaluation of transit priority measures. This methodology follows the following five steps:

1. **Develop estimates for the Capital Cost** using preliminary cost estimates based on functional designs.
2. **Develop estimates for annual operating cost** using approximate costs for similar measures.
3. **Develop operational cost savings to Halifax Transit** using estimates in delay reductions to transit vehicles. This can be obtained from field observation or traffic modeling and a combination of both have been used for this project.
4. **Understand the TPM's Impact to All Road Users** using estimates in changes in delay to the movement of people using the particular intersection or corridor. This includes changes in delay to transit users as well as any estimated change in delay to motorists, cyclists, or pedestrians.
5. **Determine the payback period for the Measure** using the results of the previous four steps.



To estimate the impact on transit flow that could be expected with each option along each corridor, the delay reductions to the average transit vehicle have been estimated using traffic analysis (Synchro 9 and SimTraffic) and supplemented with field observation and transit data provided by Halifax Transit. This analysis has been carried into the cost analysis and overall evaluation. The methodology to calculate the delay and payback period are included in Appendix E.

3.3.2 MULTIMODAL LEVEL OF SERVICE (MMLOS)

Multimodal level of service (MMLOS) is an evaluation framework that takes a more holistic approach to intersection performance analysis than the typical vehicle-focused models that are commonplace. The framework for MMLOS is based on *NCHRP Report 616* (National Cooperative Highway Research Program NCHRP, Washington, 2008), a publication that summarizes the results of a 2-year investigation of how users perceive the multimodal quality of service on urban streets. LOS models were calibrated that rate the level of comfort and delay felt by pedestrian, bicycle, and transit users at an intersection and along a corridor and enable the analysis of “tradeoffs” of various allocations of the urban street cross section among auto, pedestrian, bicycle, and transit users. The intent is to provide a more complete representation of how key variables impact the accommodation of different road users.

The NCHRP framework for MMLOS has been applied to evaluate design alternatives for the study area. The following summarizes the NCHRP framework and how it was applied to this project:

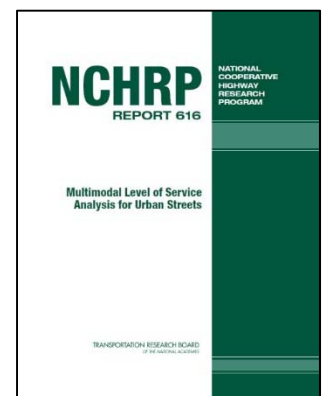

- NCHRP 616 included MMLOS models for corridors and signalized intersections only.
- Although there are transit multimodal level of service models for corridors, the factors for transit LOS consider transit scheduling and transit amenities (benches, shelters) that are outside the scope of this project. Evaluation of transit performance along each corridor has been performed separately.
- *Highway Capacity Manual 2010* (HCM 2010, National Academy of Sciences, Washington, 2010) used the research and models included in NCHRP 616 to provide MMLOS models for intersections and segments in HCM 2010. New to HCM 2010 was the MMLOS criteria for pedestrians at Two-way STOP controlled intersections (TWSC); however, HCM 2010 does not provide bicycle MMLOS at TWSC. Table 3-2 summarizes the factors that were found to influence the level of service of pedestrians and bicyclists.

Table 3-2 - Factors that influence Intersection Multimodal LOS by Active Mode (HCM 2010)

		Pedestrian LOS	Bicyclist LOS
Signalized Intersection MMLOS	Negative Influence	<ul style="list-style-type: none"> • Volume of right turns on red • Volume of permitted left turns • Traffic in outside lane • Traffic speed • Number of lanes • Pedestrian delay • Right-turn channelized lanes (low traffic volume locations) 	<ul style="list-style-type: none"> • Width of cross street • Volume of traffic
	Positive Influence	<ul style="list-style-type: none"> • Right-turn channelized lanes (high traffic volume locations) 	<ul style="list-style-type: none"> • Width of outside through lane (and bicycle lane) • Number of lanes on approach direction
Two-Way STOP-Controlled Intersection MMLOS	Negative Influence	<ul style="list-style-type: none"> • Vehicle volume • Crosswalk length • Number of lanes 	No model provided
	Positive Influence	<ul style="list-style-type: none"> • Crosswalk width • Driver yield rates 	
Overall Segment	Negative Influence	<ul style="list-style-type: none"> • Traffic volume per lane • Vehicle travel speed • Poor intersection MMLOS 	<ul style="list-style-type: none"> • Signalized Intersections • Traffic volume per lane • Vehicle travel speed • Heavy vehicle volume • Poor intersection MMLOS
	Positive Influence	<ul style="list-style-type: none"> • Width of outside through lane (and bicycle lane) • Parking occupancy • Presence of sidewalk buffer • Sidewalk width 	<ul style="list-style-type: none"> • Width of outside through lane (and bicycle lane)

3.3.3 PARKING / LOADING

WSP has conducted field review to quantify the available parking / loading along each corridor and consider the impact to parking and loading with each option.

3.3.4 ROAD SAFETY

WSP has reviewed available collision records and how the options could be expected to impact road safety through changes to the number of conflict points and expected travel speeds.

3.3.5 COST ESTIMATES

With each option developed for these corridors, Class D cost estimates have been prepared to estimate the construction cost. These estimates are considered high level estimates and do not include property acquisition or HST. Cost Estimates for each option are included in Appendix D.

3.3.6 OVERALL ANALYSIS

Using consideration of the above factors and results from the public and stakeholder consultation, overall evaluation matrices were developed for each corridor in order to display the overall assessment of each option and enable comparison between categories (identified in Table 3-3). For simplicity, the matrices has been formatted to a colour scale from green (most favorable) to red (least favorable), with yellow the intermediate shade. Grey was used to indicate criteria that were not applicable or where information was not available. It should be recognized that since this evaluation scheme does not apply weighting factors to the various evaluation criteria, it essentially assigns equal value to each criteria. This is obviously not the case in reality, as transit schedule adherence may be a more influential factor on these identified transit corridors than traffic impacts. As presented, the evaluation matrix is a visual tool that enables high level options comparison.

Each option for the full corridor has also been evaluated using the payback period analysis methodology included in *Moving Forward Together Plan* (Halifax Transit, 2016) with the methodology shown in Appendix E.

Table 3-3 - Considered Categories for Analysis

	Transit Travel Time
	Transit Schedule Reliability
	Transit Visibility
User Experience	Walking
	Bicycling
	MMLOS
	Road Safety
Impacts	Traffic Impacts
	Property Requirements
	Green space / Urban Forest
	Implementation Cost
Public Support	Public Feedback Response

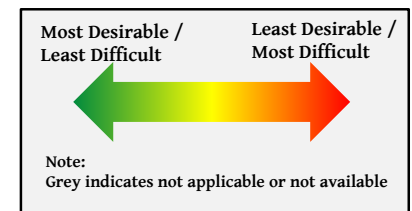

This Space Intentionally Left Blank

4 GOTTINGEN STREET

4.1 EXISTING CONDITIONS

Gottingen Street between Cogswell Street and North Street (approximately 1.1 km) is a two-lane arterial roadway. Traffic data obtained by HRM Traffic Management indicate a weekday two-way traffic volume of approximately 8,400 vehicles per day (vpd).

Along the corridor, the intersections of North Street, Cornwallis Street, and Cogswell Street are signalized. The remaining seven intersections (with Charles Street, Uniacke Street, Buddy Daye Street, Cunard Street, Falkland Street, and Portland Place) are all T-intersections with STOP control on the side street and free flow on Gottingen Street.

With approximately 10 metres of asphalt width on Gottingen Street south of Buddy Daye Street and intermittent parking available on both sides, the flow of transit and traffic vehicles are already impacted by the narrowed through lanes (See Figure 4-1).

Although much of this corridor is theoretically free flow, congestion has been observed throughout the day, particularly during the PM peak period when northbound traffic queues toward North Street extend along the corridor (See Figure 4-2).



Photo 3 - Queued outbound bus - 4:45 PM

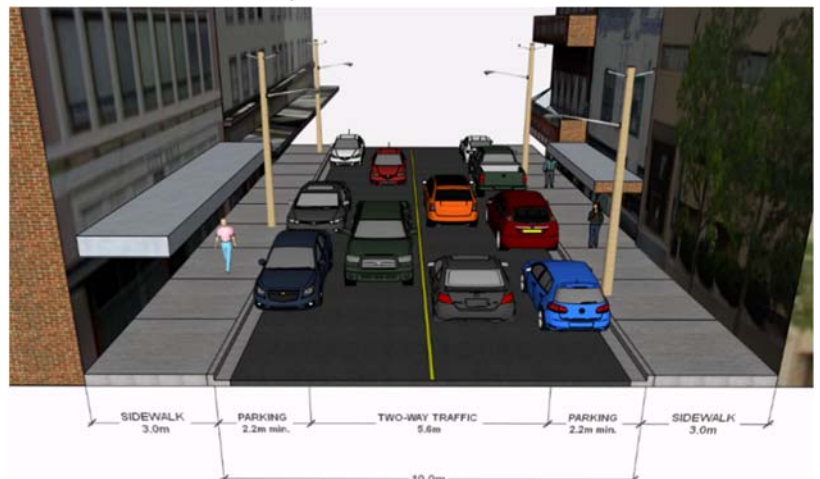

Figure 4-1 - Gottingen Street Typical Cross Section Looking South
Buddy Daye Street to Falkland Street



Figure 4-2 - Google Traffic Map - 5:00 PM, Wednesday, July 19, 2017

4.1.1 EXISTING TRANSIT

Gottingen Street is a very busy transit corridor for Halifax Transit, particularly during the PM peak period. It is currently used by 18 Halifax Transit Routes (#1, 7, 10, 11, 21, 31, 33, 34, 41, 53, 59, 61, 68, 86, 159, 320, 330, and 370). Transit vehicle volume and ridership data were collected by Halifax Transit and are summarized in Table 4-1.

Table 4-1 - Existing Transit Volumes and Ridership along Existing Routes

		Transit Vehicles	Transit Riders
AM Peak Hour	Southbound	15	770
	Northbound	25	200
PM Peak Hour	Southbound	4	50
	Northbound	56	1600

4.1.2 EXISTING TRAFFIC

Turning movement counts at the Gottingen Street intersections with North Street, Cornwallis Street, and Cogswell Street were collected by HRM Traffic Management for the morning (7-9 AM) and afternoon (4-6 PM) peak periods. The AM and PM design hour volumes are summarized in Figure 4-3. Traffic analysis of existing conditions was prepared using Synchro 9 and is summarized in Appendix F.

Additional pedestrian volume data were provided by HRM Traffic Management for the existing crosswalks at Charles Street, Uniacke Street, Buddy Daye Street, and Cunard Street. No pedestrian volume data were available for the marked crosswalk at Falkland Street.

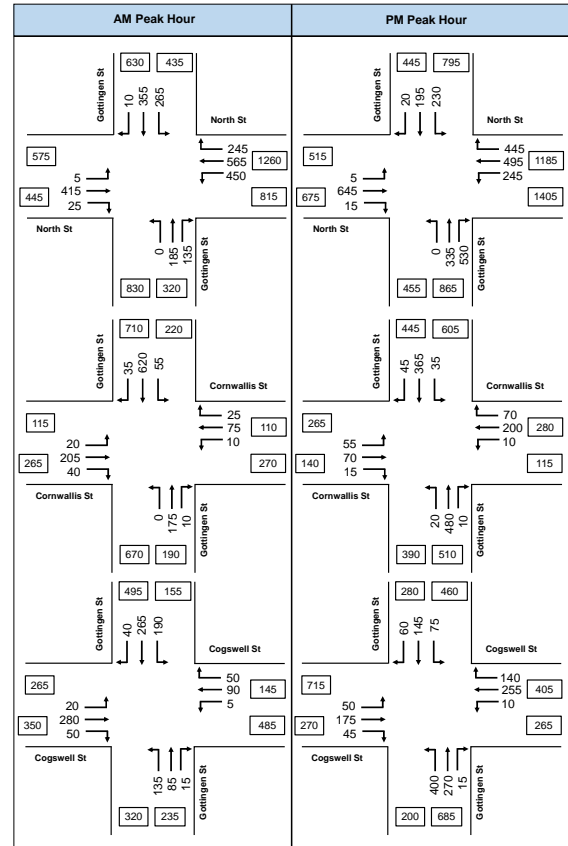

Figure 4-3 - Gottingen St Corridor AM and PM design hour traffic volumes

4.1.3 EXISTING MULTIMODAL ANALYSIS

Using available traffic, pedestrian, and bicycle count data from HRM Traffic Management and the geometric configuration of the existing sidewalk and lane layouts, the pedestrian and bicycle multi-modal level of service for the key intersections and corridor segments were determined.

Analysis finds that the segment MMLOS for pedestrians is 'C' or 'D' and for bicyclists is 'D' in each of the AM and PM peak hours.

4.1.4 ROAD SAFETY

Available data for collisions occurring within the Gottingen Street study area in 2015 and 2016 were provided by the Halifax Regional Police and reviewed to consider if any mitigative measures could be identified. The available collision reports indicate that of the 31 reported study area collisions with available information, approximately 40% (12) involved a parked vehicle. No other trends were identified.

4.1.5 EXISTING PARKING



During the day, parking is permitted on Gottingen Street as shown in Figure 4-4. Additional no stopping restrictions are in place on the east (northbound) side between 4-6 PM.



Figure 4-4 - Existing Parking on Gottingen Street

4.2 GOTTINGEN STREET MODIFICATION OPTIONS

Three modification options were prepared for the Gottingen Street study area and are summarized below. Functional design plans for each option are included in Appendix A and cost estimates are included in Appendix D.

Option	Description
<p data-bbox="204 554 228 730" style="writing-mode: vertical-rl; transform: rotate(180deg);">High Investment</p> <p data-bbox="248 401 670 426">Option G1 – Continuous NB Transit Lane</p>  <p data-bbox="248 730 581 756">*Proposed cross section looking south</p>	<ul data-bbox="943 401 1516 541" style="list-style-type: none"> • Remove parking/loading from Gottingen Street; • Provide a continuous northbound right turn lane (except buses); and, • Install Pedestrian Half-Signals at Key Pedestrian Crossings. <p data-bbox="894 548 980 573"><u>Impacts:</u></p> <ul data-bbox="943 579 1516 884" style="list-style-type: none"> • Provides a continuous transit lane in the critical northbound direction. • Removal of parking and separation of northbound buses is expected to improve flow of traffic along the corridor. • Positive for safety due to noted collision trend and less need to cross centre line to get around parked vehicles. • Analysis (Appendix F) indicates minimal impact to non-transit vehicles while providing significant transit benefit.
<p data-bbox="204 1041 228 1218" style="writing-mode: vertical-rl; transform: rotate(180deg);">Medium Investment</p> <p data-bbox="248 896 792 921">Option G2 – NB Transit Priority at Key Intersections</p>  <p data-bbox="248 1222 800 1247">*Proposed cross section looking south at key intersections only</p>	<ul data-bbox="943 896 1516 1066" style="list-style-type: none"> • Remove parking/loading from Gottingen Street during peak periods; • Provide transit queue jump lanes at key locations; and, • Install Pedestrian Half-Signals at Key Pedestrian Crossings <p data-bbox="894 1073 980 1098"><u>Impacts:</u></p> <ul data-bbox="943 1104 1516 1402" style="list-style-type: none"> • Provides transit priority measures at key locations while having minimal impact on parking/loading during offpeak periods. • Improved flow of traffic along the corridor is expected during peak periods. • Positive for safety due to noted collision trend and less need to cross centre line to get around parked vehicles. • Analysis at the Cornwallis Street intersection (Appendix F) indicates minimal impact to non-transit vehicles while providing transit benefit.
<p data-bbox="204 1497 228 1652" style="writing-mode: vertical-rl; transform: rotate(180deg);">Low Investment</p> <p data-bbox="248 1415 678 1440">Option G3 – Remove Peak Period Parking</p>  <p data-bbox="248 1713 581 1738">*Proposed cross section looking south</p>	<p data-bbox="894 1472 980 1497"><u>Impacts:</u></p> <ul data-bbox="943 1503 1516 1696" style="list-style-type: none"> • Does not specifically provide transit priority. • Minor improvements to flow of traffic (and transit) along the corridor considering current restriction already in place during PM peak for northbound. • Positive for safety due to noted collision trend and less need to cross centre line to get around parked vehicles.

4.3 GOTTINGEN STREET OPTIONS EVALUATION

Using the available data, traffic flow models were created using SimTraffic to develop estimates for changes in user delay with each option. Table 4-2 summarizes the benefits to transit and non-transit users and the estimated implementation costs (See Appendix D).

An options evaluation matrix was created in order to display the overall assessment of each option and enable comparison between categories (See Table 4-3). As presented, the evaluation matrix is a visual tool that enables high level options comparison.

Table 4-2 - Gottingen Street - Overall Corridor Options Summary

Corridor Segment	G1 - Continuous NB Transit Lane	G2 - Transit Priority at Key Intersections	G3 - Remove Parking
Total Estimated Annual Operating Cost Savings to Halifax Transit	\$36,625	\$8,610	\$3,340
Total Estimated Daily Reduction in Transit User Delay	65 hrs	15 hrs	5 hrs
Total Estimated Daily Reduction in Overall User Delay	70 hrs	20 hrs	10 hrs
Total Estimated Implementation Cost	\$0.25 Million	\$0.22 Million	Negligible Cost (Signage Only)

Table 4-3 Gottingen Street Options Evaluation Summary Matrix

		Transit Corridor Options			
		Existing Conditions	G1. Continuous NB Lane	G2. NB Transit Priority - Key Locations	G3. Parking / Loading Modifications
User Experience	Transit Travel Time	Orange	Green	Yellow	Orange
	Transit Schedule Reliability	Red	Green	Green	Orange
	Transit Visibility	Red	Green	Green	Red
	Walking	Green	Green	Green	Green
	Bicycling	Yellow	Orange	Yellow	Green
	MMLOS	Yellow	Orange	Yellow	Yellow
	Road Safety	Yellow	Green	Green	Green
Impacts	Traffic Impacts	Grey	Green	Green	Green
	Loading/Parking Impacts	Grey	Red	Orange	Orange
	Implementation Cost	Grey	Green	Green	Green
Public Support	Public Feedback Response	Grey	Green	Green	Yellow

Most Desirable / Least Difficult Least Desirable / Most Difficult

Note: Grey indicates not applicable or not available

Note: There is no anticipated impact to the right of way width or available space for green space / urban forest.

Each option for the full corridor was evaluated using the payback period analysis methodology included in *Moving Forward Together Plan* (Halifax Transit, 2016) and summarized in Section 3.3.1. The methodology is included in Appendix E with results summarized in Table 4-4.

Table 4-4 - Overall Payback Period Analysis – Gottingen Street

		Gottingen Street		
		G1- Continous Northbound Transit Lane	G2- NB Transit Priority at Key Intersections	G3- Remove Peak Period Parking; No Specific Transit Priority
Estimated Daily Delay Savings to Transit Users		~65 pass.hr	-15 pass.hr	~5 pass.hr
Estimated Daily Delay Savings to All Road Users		~70 pass.hr 5	~20 pass.hr 4	~10 pass.hr 3
Payback Period		0.6 years 5	2.0 years 4	N/A 5
Other Key Factors	Score for Other Factors ¹	3	1	0
	Safety Considerations	(+)Improved flow through network and reduced parking manoeuvres		
	Impact to Other Users	(-)Loss of Parking Half signal for pedestrians may improve pedestrian safety but increase pedestrian delay		(-)Loss of Parking
	Project Integration	None identified		
	TPM Enforcement Requirements	Enforcement of typical signage required		None
	Issues to Implementation	None		
	Promotion of Transit	(+)Good Promotion of Transit	Some Promotion of Transit	None
Schedule Adherence	(++)Greatly improved schedule adherence	(+)Improved schedule adherence	(+)Some improvements may be realized	
Public Consultation	(++)Generally viewed as the best option overall	(+)Viewed as a good option	Generally seen as the least desirable option overall	
Stakeholder Consultation	(--)Concern for parking/loading	(-)Loss of SB parking during peak periods		
Overall Evaluation	13	9	8	
NOTES: 1. Score for other factors is the sum of the positive impacts less the negative impacts. Impacts with "++" or "--" received double score.				

Comparative evaluation of the user impacts (Table 4-3) and payback analysis (Table 4-4) indicates that greater overall benefit is expected with Option G1 (Continuous northbound transit lane) and this option should be considered for implementation by HRM.

This Space Intentionally Left Blank

5 BAYERS ROAD

5.1 EXISTING CONDITIONS

Bayers Road between Romans Avenue and Windsor Street (approximately 1.4 km) is an arterial roadway. In this area the roadway transitions from a four lane cross section near Romans Avenue (See Figure 5-2) to seven lanes around the Halifax Shopping Centre (HSC) and reduces to a three lane section plus parking east of Connaught Avenue (See Figure 5-1). Traffic data obtained by HRM Traffic Management indicate a weekday two-way traffic volume of between 15,000 and 45,000 vehicles per day (vpd).



Figure 5-2 - Typical Cross Section Looking East-Bayers Road near Romans Avenue

Significant congestion has been observed along this corridor, particularly during the peak periods when inbound traffic in the morning has been observed to back up onto Highway 102 while outbound traffic congestion during the afternoon peak has been observed to extend through the entire corridor. Travel times in the outbound direction between Oxford Street and Connaught Avenue during the PM peak period have been observed to exceed 15 minutes, indicating severe congestion in this area and contributes to shortcutting onto local streets (shown in Figure 5-3).

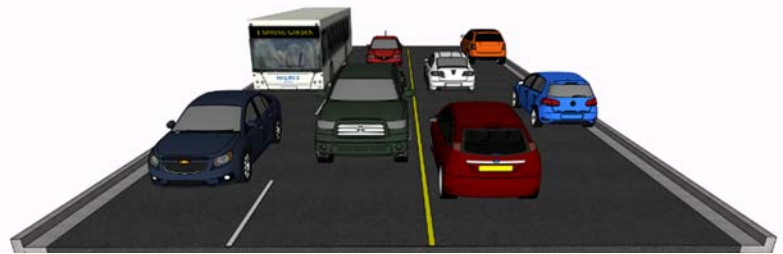

Figure 5-1 - Typical Cross Section Looking East-Connaught Avenue to Windsor Street

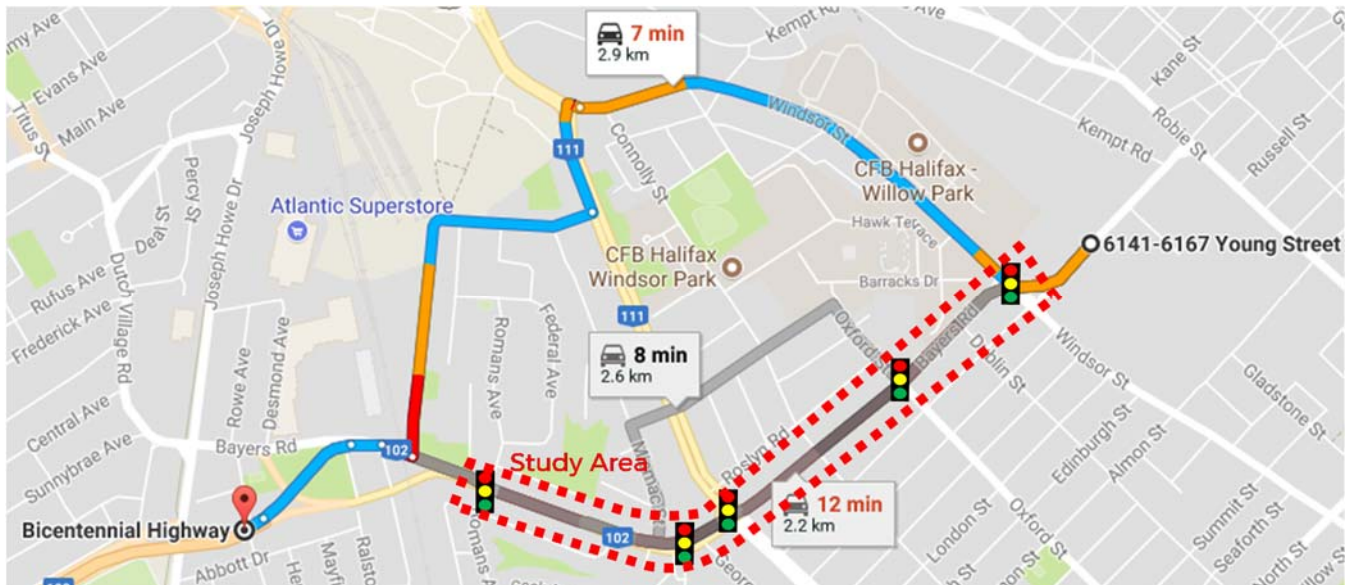

Figure 5-3 - Google Traffic Map - 4:30 PM, Tuesday, October 17, 2017
(Travel time through the uncongested corridor is approximately 4 minutes)

5.1.1 EXISTING TRANSIT

Bayers Road is currently used by 7 Halifax Transit Routes (#1, 2, 9, 17, 80, 81, and 330, See Figure 5-4). Transit ridership data were collected by Halifax Transit and indicate that at the Connaught Avenue intersection there are estimated to be:

- 37 two-way buses carrying 700 transit riders in the AM peak hour; and,
- 35 two-way two way buses carrying 730 transit riders in the PM peak hour.

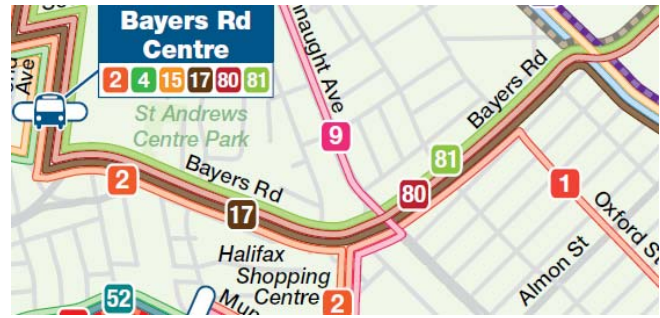

Figure 5-4 - Halifax Transit Routes on Bayers Road

5.1.2 EXISTING TRAFFIC

Turning movement counts at the Bayers Road intersections with Romans Avenue, Halifax Shopping Centre (HSC), Connaught Avenue, Oxford Street, and Windsor Street were collected by HRM Traffic Management for the morning (7-9 AM) and afternoon (4-6 PM) peak periods. AM and PM Design Hourly Volumes for the Romans, HSC, Connaught, and Windsor intersections are summarized in Figure 5-5. Traffic analysis of existing conditions was prepared using *Synchro 9* and is summarized in Appendix G.

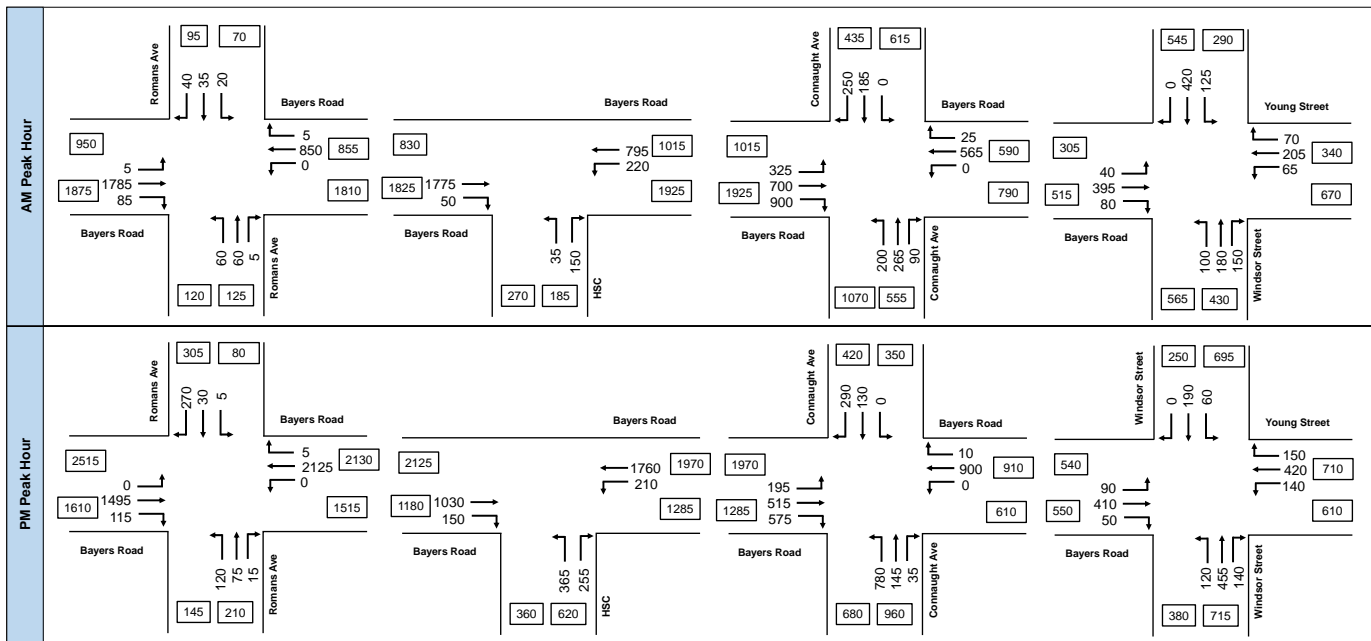

Figure 5-5 - Bayers Road Corridor AM and PM Design Hourly Traffic Volumes

5.1.3 EXISTING MULTIMODAL ANALYSIS

Using available traffic, pedestrian, and bicycle count data from HRM Traffic Management and the geometric configuration of the existing and proposed sidewalk and lane layouts, the pedestrian and bicycle multi-modal level of service for the corridor segments were estimated (See Section 3.3.2).

	Romans Avenue to Connaught Avenue	Connaught Avenue to Windsor Street
Existing Bicycle MMLOS	With high traffic volumes and no designated bicycle facilities the existing segment bicycle MMLOS is overall 'E' in both directions during the AM and PM peak hours.	With lower traffic volumes but still no designated bicycle facilities the existing segment bicycle MMLOS is overall 'D' or 'E' during the AM and PM peak hours.
Existing Pedestrian MMLOS	With high traffic volumes and sidewalk near the roadway, segment pedestrian MMLOS is overall 'D' or 'E' for both sides during the AM and PM peak hours.	With lower traffic volumes and sidewalk near the roadway, segment pedestrian MMLOS is overall 'D' for both sides during the AM and PM peak hours.

5.1.4 ROAD SAFETY

Collision reports were not available for this corridor for collision analysis. A comparative analysis between the options for this corridor considered how each option changed the number or type of conflict points.

5.1.5 EXISTING PARKING

Parking is generally restricted along this corridor with the following exceptions:

- The south side between Connolly Street and east of Dublin Street is time restricted with some unrestricted parking; and,
- The north side between Oxford Street and west of Connolly Street is signed as no stopping during the PM peak period and is otherwise unrestricted.

5.2 BAYERS ROAD MODIFICATION OPTIONS

With the changing road width and varying traffic volumes along Bayers Road, this corridor has been separated into four segments for the development and evaluation of transit priority options. The four road segments are identified in Figure 5-6.

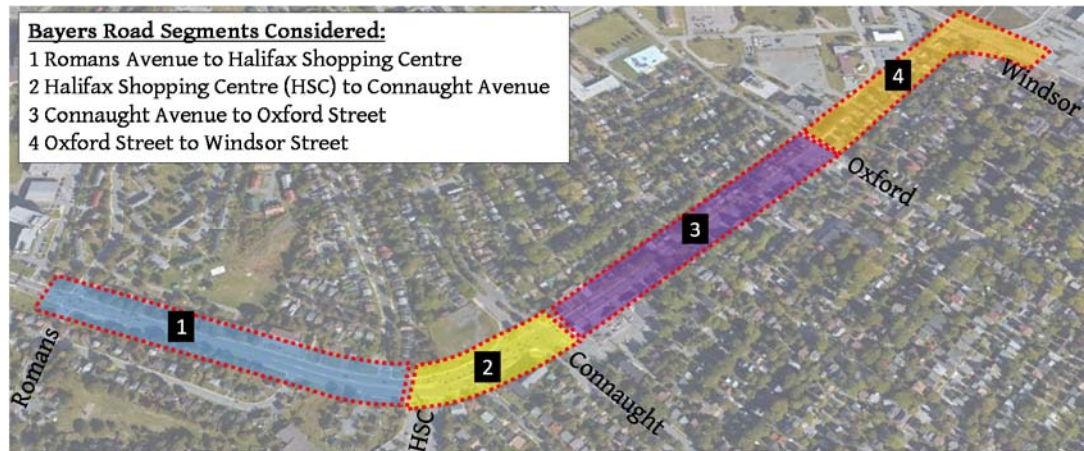

Figure 5-6 - Bayers Road Segments Considered in this Study

Recognizing the congestion, the high traffic volumes, the importance of this

corridor as a truck and traffic route to and from Peninsular Halifax, and the priorities for allocation of street space, options have been prepared for each of the segments of this corridor. These options for each segment are shown conceptually in Appendix A and described in subsequent sections of this report.

Lane Requirements:

At the outset of the project, traffic analysis was prepared to assess the lane requirements for each segment of the corridor. Analysis considered whether reductions to one through lane in each direction for non-transit could accommodate the traffic volumes without causing significant negative impact to non-transit vehicle operations.

Intersection analysis results (See Appendix G) indicate that the operations of the intersections in segments #1 and #2 (Figure 5-6) approach or exceed capacity with two through lanes for non-transit with existing volumes and lane configurations. Analysis indicates that while traffic in segments #3 and #4 could be accommodated by a single through lane in each direction, reduction to a single lane in each direction is expected to significantly impact capacity for non-transit vehicles in segments #1 and #2. Since no eastbound transit lane is proposed west of the study area, this increased congestion of non-transit vehicles is expected to impact eastbound transit movements as they approach the study area.

Traffic analysis results indicate that:

- **Two non-transit lanes** in each direction should be provided along segments #1 and #2; and,
- **One non-transit lane** in each direction along segments #3 and #4 is expected to accommodate the non-transit volumes.



Proposed AT Greenway Cost Estimates:

Although cost estimates include the installation of the proposed AT greenway between Romans and George Dauphinee, the installation of the greenway is not considered integral to the provision of transit priority along this corridor and has not been included in the cost-benefit analysis of the transit options.

It is estimated that the total installation cost (excluding property acquisition and HST) of the proposed AT greenway between Romans Avenue and George Dauphinee Avenue is approximately \$335,000 and is not contingent on which roadway option is selected.

5.2.1 ROMANS AVENUE TO HALIFAX SHOPPING CENTRE

This segment of Bayers Road has two through lanes in each direction and experiences very heavy through volumes during the AM and PM peak periods. Two modification options (plans included in Appendix A) were prepared for this segment and are summarized below. Intersection analysis is included in Appendix G.

Option		Description
High Investment	1 – Widen to Install Continuous EB and WB Transit Lanes 	<ul style="list-style-type: none"> Widen on south side to provide a continuous eastbound and westbound transit lanes; and, Install offstreet active transportation greenway. <p><u>Impacts:</u></p> <ul style="list-style-type: none"> Requires some property acquisition on south side of Bayers Road. Provides a full-time continuous transit lane in both directions. Removes transit vehicles and right turns from flow of non-transit vehicles Provides offstreet active transportation greenway
Medium Investment	2 – Widen to Install Reversible Lane and designate transit lane in peak direction 	<ul style="list-style-type: none"> Widen on southside to provide a continuous eastbound transit lane in the AM peak period and westbound transit lane in the PM peak period; Install reversible lane signage (similar to Chebucto Road, Macdonald Bridge); and, Install offstreet active transportation greenway. <p><u>Impacts:</u></p> <ul style="list-style-type: none"> Requires some property acquisition on south side of Bayers Road. Provides a full-time continuous transit lane in peak direction. Removes transit vehicles and right turns from flow of non-transit vehicles in peak direction. Provides offstreet active transportation greenway. Negative safety impact with reversible lane and complicated time of day transit lane signage.

An options evaluation matrix was created in order to display the overall assessment of each option and enable comparison between categories (See Table 5-1).

Table 5-1 – Bayers Road – Romans Avenue to Coleman Court Options Evaluation Summary Matrix

		Transit Corridor Options		
		Existing Conditions	1. Continuous Transit Lanes	Opt 2. Reversible Lane
User Experience	Transit Travel Time	Red	Green	Green
	Transit Schedule Reliability	Red	Green	Orange
	Transit Visibility	Red	Green	Yellow
	Walking	Orange	Yellow	Yellow
	Bicycling	Red	Green	Green
	MMLoS	Orange	Green	Green
	Road Safety	Yellow	Green	Red
Impacts	Traffic Impacts	Grey	Green	Yellow
	Property Requirements	Grey	Orange	Orange
	Green space / Urban Forest	Grey	Orange	Yellow
	Implementation Cost	Grey	Orange	Orange
Public Support	Public Feedback Response	Grey	Green	Yellow

Most Desirable / Least Difficult ← → Least Desirable / Most Difficult

Note: Grey indicates not applicable or not available

Note: Parking is already restricted and there is no proposed change to parking.

5.2.2 HALIFAX SHOPPING CENTRE (HSC) TO CONNAUGHT AVENUE

With approximately 100 metres between the Connaught and HSC (east) intersection, queuing and lane changes by turning traffic are frequently observed. Modification options (plans included in Appendix A) were prepared for this segment and are summarized below. Intersection analysis is included in Appendix G.

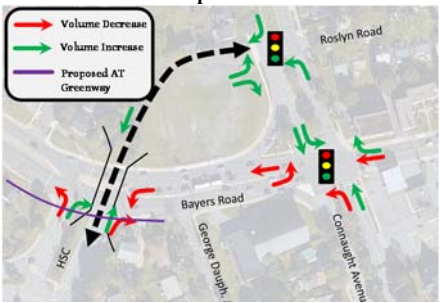
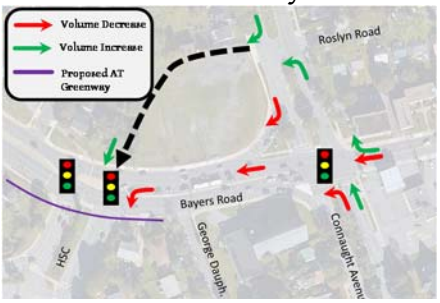
Option	Description
<p style="writing-mode: vertical-rl; transform: rotate(180deg);">High Investment</p>	<p>1 – Construct Overpass To HSC</p>  <ul style="list-style-type: none"> Reprofile Bayers Road and Connaught Avenue to install grade separation over Bayers Road for connection to HSC; Remove traffic signals from HSC intersections; Install traffic signals at Connaught Avenue / Roslyn Road intersection; Modify HSC (west) driveway to become right-in, right-out only; and, Install offstreet active transportation greenway. <p><u>Impacts:</u></p> <ul style="list-style-type: none"> Requires property acquisition. Impacts access to HSC. Impacts grades on Bayers Road and access to adjacent properties. Expected to significantly improve traffic flow. Reduced merging manoeuvres are expected to provide significant safety improvement. Removes signalized crossing for AT greenway through this segment. Expected to create significant disruption during construction.
<p style="writing-mode: vertical-rl; transform: rotate(180deg);">Medium Investment</p>	<p>2A – Construct new roadway to HSC</p>  <ul style="list-style-type: none"> Construct a driveway connecting Connaught Avenue opposite Roslyn Road to Halifax Shopping Centre; Restrict left turns from Bayers Road to Halifax Shopping Centre; and, Install offstreet active transportation greenway. <p><u>Impacts:</u></p> <ul style="list-style-type: none"> Requires property acquisition. Impacts access to HSC. Expected to improve traffic flow. Reduced merging manoeuvres expected to provide safety improvement. Analysis (Appendix G) indicates benefit to transit and non-transit. <p>2B – Construct new transit-only roadway to HSC</p> <p>(Option developed following Public Consultation)</p> <ul style="list-style-type: none"> Similar to Option 2A, a roadway could be constructed that would allow transit vehicles to access HSC and allow right turns onto Bayers Road into a transit only lane. This would allow outbound transit vehicles to bypass congestion in this segment without changing access to HSC. <p><u>Impacts:</u></p> <ul style="list-style-type: none"> Requires property acquisition. No safety benefit of reduced merging / diverging of turning traffic to HSC. Requires installation of a receiving lane for transit vehicles on private property. May complicate operations on HSC property.
<p style="writing-mode: vertical-rl; transform: rotate(180deg);">Low Investment</p>	<p>3 – Widen to provide transit lanes</p> <ul style="list-style-type: none"> Widen to construct transit lanes; and, Install offstreet active transportation greenway. <p><u>Impacts:</u></p> <ul style="list-style-type: none"> Requires property acquisition. Widens already wide roadway and extends pedestrian crossing distance. Little impact on traffic flow.

An options evaluation matrix was created in order to display the overall assessment of each option and enable comparison between categories (See Table 5-2).

Table 5-2 – Bayers Road – Coleman Court to Connaught Avenue Options Evaluation Summary Matrix



		Transit Corridor Options				
		Existing Conditions	Opt 1. Overpass to HSC	Opt 2A. Realigned HSC	Opt 2B. Transit only roadway	Opt 3. Widen to Install Transit Lanes
User Experience	Transit Travel Time	Red	Green	Light Green	Light Green	Yellow
	Transit Schedule Reliability	Red	Green	Light Green	Light Green	Light Green
	Transit Visibility	Red	Light Green	Light Green	Light Green	Light Green
	Walking	Orange	Light Green	Yellow	Yellow	Orange
	Bicycling	Red	Green	Light Green	Light Green	Light Green
	MMLOS	Orange	Light Green	Light Green	Light Green	Yellow
	Road Safety	Orange	Light Green	Yellow	Yellow	Orange
Impacts	Traffic Impacts	Grey	Green	Light Green	Yellow	Yellow
	Property Requirements	Grey	Red	Orange	Orange	Orange
	Green space / Urban Forest	Grey	Yellow	Yellow	Yellow	Yellow
	Implementation Cost	Grey	Red	Yellow	Yellow	Yellow
Public Support	Public Feedback Response	Grey	Green	Light Green	Grey	Yellow

Most Desirable / Least Difficult  Least Desirable / Most Difficult
 Note: Grey indicates not applicable or not available

Notes: Parking is already restricted and there is no proposed change to parking.
Public input is not available for Option 2B.

5.2.3 CONNAUGHT AVENUE TO WINDSOR STREET

Traffic volumes collected by HRM indicate that peak period through volumes along this section are generally around 500-700 vehicles per direction. Three modification options (plans included in Appendix A) were prepared for this segment and are summarized below. Intersection analysis is included in Appendix G.

Option	Description
<p>High Investment</p> <p>1 - Install EB and WB transit lanes</p> 	<ul style="list-style-type: none"> Widen to provide a continuous eastbound and westbound transit lane; and, Remove parking. <p><u>Impacts:</u></p> <ul style="list-style-type: none"> Requires some property acquisition along the full corridor. Removes parking. Slight negative impact to westbound non-transit vehicles. Provides a full-time continuous transit lane in both directions. Removes transit vehicles and right turns from traffic flow.
<p>Medium Investment</p> <p>2 - Install reversible lane and designate transit lane in peak direction</p> 	<ul style="list-style-type: none"> Provide a continuous eastbound transit lane in the AM peak period and westbound transit lane in the PM peak period; Install reversible lane signage (similar to Chebucto Road, Macdonald Bridge); and, Remove parking. <p><u>Impacts:</u></p> <ul style="list-style-type: none"> Requires some property acquisition around Connaught Avenue and Oxford Street. Removes parking. Slight negative impact to westbound non-transit vehicles. Provides a full-time continuous transit lane in peak directions. Removes transit vehicles and right turns from traffic flow in peak direction. Negative safety impact with reversible lane and complicated time of day transit lane signage.
<p>Low Investment</p> <p>3 - Install WB transit lane</p> 	<ul style="list-style-type: none"> Provide a continuous westbound transit lane; and Remove parking in westbound direction. <p><u>Impacts:</u></p> <ul style="list-style-type: none"> Requires some property acquisition around Connaught Avenue. Removes some parking from north side. Slight negative impact to westbound non-transit vehicles. Provides some transit priority in westbound direction only.

An options evaluation matrix was created in order to display the overall assessment of each option and enable comparison between categories (See Table 5-3).

Table 5-3 – Bayers Road –Connaught Avenue to Windsor Street Options Evaluation Summary Matrix

		Transit Corridor Options			
		Existing Conditions	1. Continuous transit lanes both directions	2. Reversible lane	3. Transit Lane WB
User Experience	Transit Travel Time	Red	Green	Light Green	Yellow
	Transit Schedule Reliability	Red	Green	Light Green	Light Green
	Transit Visibility	Red	Green	Light Green	Light Green
	Walking	Yellow	Yellow	Yellow	Yellow
	Bicycling	Orange	Orange	Orange	Orange
	MMLOS	Orange	Orange	Orange	Orange
	Road Safety	Orange	Light Green	Orange	Light Green
Impacts	Traffic Impacts	Grey	Yellow	Yellow	Yellow
	Property Requirements	Grey	Orange	Yellow	Yellow
	Loading/Parking Impacts	Grey	Red	Red	Orange
	Green space / Urban Forest	Grey	Orange	Yellow	Yellow
	Implementation Cost	Grey	Yellow	Yellow	Light Green
Public Support	Public Feedback Response	Grey	Green	Light Green	Yellow

Most Desirable / Least Difficult ← → Least Desirable / Most Difficult

Note: Grey indicates not applicable or not available

5.2.4 WINDSOR STREET INTERSECTION

This intersection experiences awkward lane alignment and intersection geometry. Although roundabout configurations were considered, they were excluded due to significant property impacts and challenging signage requirements. Two modification options (plans included in Appendix A) were prepared for this intersection and are summarized below. Intersection analysis is included in Appendix G.

Option	Description
1 – Modify right turn channels and install EB and WB transit lanes	<ul style="list-style-type: none"> Modify alignment of right turn channels from Windsor Street to Bayers Road and Young Street; Designate a westbound lane as right turn only (except buses); and, Widen to install an eastbound right turn lane (except buses). <u>Impacts:</u> <ul style="list-style-type: none"> Requires some property acquisition Provides a full-time continuous transit lane in both directions. Removes transit vehicles and right turns from traffic flow.
2 – Install WB transit lane	<ul style="list-style-type: none"> Provide a continuous westbound transit lane; and, <u>Impact:</u> <ul style="list-style-type: none"> Provides transit priority in westbound direction.

An options evaluation matrix was created in order to display the overall assessment of each option and enable comparison between categories (See Table 5-4).

Table 5-4 – Bayers Road at Windsor Street Intersection Options Evaluation Summary Matrix

		Transit Corridor Options		
		Existing Conditions	1. Continuous transit lanes both directions	2. Transit Lane WB
User Experience	Transit Travel Time	Orange	Green	Yellow
	Transit Schedule Reliability	Orange	Green	Light Green
	Transit Visibility	Orange	Green	Light Green
	Walking	Orange	Light Green	Yellow
	Bicycling	Orange	Yellow	Orange
	MMLOS	Orange	Yellow	Orange
	Road Safety	Orange	Light Green	Yellow
Impacts	Traffic Impacts	Grey	Yellow	Yellow
	Property Requirements	Grey	Orange	Yellow
	Green space / Urban Forest	Grey	Light Green	Yellow
	Implementation Cost	Grey	Orange	Yellow
Public Support	Public Feedback Response	Grey	Green	Yellow



Note: Grey indicates not applicable or not available

Note: Parking at the intersection is not permitted and there is no proposed change to parking

5.3 BAYERS OPTIONS EVALUATION

In performing the overall analysis and evaluation for the full corridor it is recognized that the impacts of implementing a particular option in one segment may impact the operations in another segment. Several options (summarized in Table 5-5) were considered for the purpose of evaluating the measures along the full corridor.

Table 5-5 - Bayers Road – Overall Corridor Options Summary

		Transit Corridor Option - Bayers Road					
		B1.1 - High Investment Full Corridor	B1.2A - High Investment Med at HSC	B1.2B - High Investment Med (Transit Only) at HSC	B1.3 - High Investment Low at HSC	B2 - Medium Investment Full Corridor	B3 - Low Investment Full Corridor
Corridor Segment	Romans to HSC	Opt 1 (Continuous lanes each direction)				Opt 2: (Reversible Lane)	
	HSC to Connaught	Opt 1 (Overpass)	Opt 2A (Construct new roadway)	Opt 2B (Construct new transit roadway)	Opt 3 (Install transit lanes in both directions)	Opt 2A (Construct new roadway)	Opt 3 (Install transit lanes in both directions)
	Connaught to Windsor	Opt 1 (Continuous lanes each direction)				Opt 2 (Reversible Lane)	Opt 3 (Transit lane westbound only)
	Windsor Street Intersection	Opt 1 (Continuous lanes each direction)				Opt 2 (Modify RT channels and install EB and WB transit lanes)	
Estimated Results	Total Estimated Annual Operating Cost Savings to Halifax Transit	\$71,150	\$44,120	\$44,120	\$29,800	\$36,055	\$19,770
	Total Estimated Daily Reduction in Transit User Delay	100 hrs	60 hrs	60 hrs	40 hrs	50 hrs	25 hrs
	Total Estimated Daily Reduction in Overall User Delay	310 hrs	140 hrs	60 hrs	50 hrs	130 hrs	35 hrs
	Total Estimated Implementation Cost	\$15.9 Million	\$4.8 Million	\$4.8 Million ¹	\$3.3 Million	\$4.6 Million	\$2.1 Million
Note:	1. Cost estimates for the implementation of HSC option 2B (medium, transit only) have not specifically been prepared, however, it is expected to be similar to cost estimates to implement option 2A in that segment.						

An options evaluation matrix was created in order to display the overall assessment of each option and enable comparison between categories (See Table 5-6). Each option for the full corridor was evaluated using the payback period analysis methodology (See Appendix E) included in Moving Forward Together Plan (Halifax Transit, 2016) and as described in Section 3.3.1 with results summarized in Table 5-7.

Table 5-6 - Bayers Road – Overall Corridor Options Evaluation Summary Matrix

		Existing Conditions	Transit Corridor Options				
			B1.1 High Investment	B1.2A High with Med at HSC	B1.2B High with Med (Transit Only) at HSC	B1.3 High with Low at HSC	B2. Medium Investment
User Experience	Transit Travel Time	Red	Green	Green	Green	Yellow	Yellow
	Transit Schedule Reliability	Red	Green	Green	Green	Green	Orange
	Transit Viability	Red	Green	Green	Green	Green	Yellow
	Walking	Orange	Green	Green	Green	Green	Yellow
	Bicycling	Red	Green	Green	Green	Green	Yellow
	MMLLOS	Orange	Green	Green	Green	Green	Yellow
Impacts	Road Safety	Orange	Green	Green	Green	Orange	Yellow
	Traffic Impacts	Grey	Green	Green	Green	Green	Yellow
	Property Requirements	Grey	Orange	Yellow	Yellow	Green	Green
	Green space / Urban Forest	Grey	Orange	Yellow	Yellow	Orange	Yellow
Public Support	Loading/Parking Impacts	Grey	Orange	Yellow	Yellow	Orange	Yellow
	Implementation Cost	Grey	Red	Orange	Yellow	Orange	Yellow
Public Support	Public Feedback Response	Grey	Green	Green	Green	Yellow	Orange

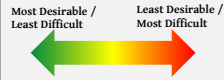

Note: Grey indicates not applicable or not available

Comparative evaluation of the user impacts (Table 5-6) and payback analysis (Table 5-7) indicate that although significant delay savings are anticipated with Option B1.1 (High Investment), after consideration of cost, property impacts, and urban form, the best overall option is expected to be Option B1.2A (High Investment, Medium through HSC segment) which offers a strong mix for all users and this option should be considered for implementation by HRM.

Table 5-7 – Bayers Road Corridor Options - Payback Period Analysis

		Bayers Road					
		B1.1-High Investment Full Corridor	B1.2A-High Investment Medium at HSC	B1.2B-High Investment Medium (Transit Only) at HSC ²	B1.3-High Investment Low at HSC	B2- Medium Investment	B3-Low Investment
Estimated Daily Delay Savings to Transit Users		~100 pass.hr	~60 pass.hr	~60 pass.hr	~40 pass.hr	~50 pass hr	~25 pass.hr
Estimated Daily Delay Savings to All Road Users		~310 pass.hr 5	~140 pass.hr 4	~70 pass.hr 3	~50 pass.hr 3	~130 pass hr 4	~35 pass.hr 3
Payback Period to Public		9.0 years 4	6.1 years 5	13.3 years 3	14.4 years 3	6.2 years 5	10.0 years 4
Score for Other Factors ¹		5	5	6	4	1	1
Safety Considerations		(-)Grade separation removes merging and crossing conflicts	Reduced congestion may provide improvement	Reduced congestion may provide improvement	Separation of buses from through movement may provide some improvement	(-)Reversible lane may not be understood by all drivers Reduced congestion may provide improvement	Separation of buses from through movement may provide some improvement
Impact to Other Users		(+)Provides grade separated crossings for AT users (+)Significant improvements for emergency vehicles	(+)Improvements for emergency vehicles	(+)Improvements for emergency vehicles	(+)Some improvements for emergency vehicles	(+)Improvements for emergency vehicles	(+)Some improvements for emergency vehicles
Project Integration		Opportunity to integrate with new AT greenway between Romans and George Dauphinee					
TPM Enforcement Requirements		No Specific Requirements Identified					
Issues to Implementation		(-)Property acquisition required along full corridor (-)Impacts to access for HSC and other properties (-)Grading challenges through HSC segment	(-)Property acquisition required along full corridor (-)Impacts to access for HSC	(-)Property acquisition required along full corridor	(-)Property acquisition required along full corridor	(-)Property acquisition required along full corridor (-)Impacts to access for HSC	(-)Property acquisition required along a portion of the corridor
Promotion of Transit		(++)Excellent promotion of transit	(++)Excellent promotion of transit	(++)Excellent promotion of transit	(++)Excellent promotion of transit	(+)Good Promotion of Transit	Some Promotion of Transit
Schedule Adherence		(++)Greatly improved Schedule adherence in both directions	(++)Greatly improved Schedule adherence in both directions	(++)Greatly improved Schedule adherence in both directions	(+)Improved Schedule adherence in both directions	(+)Improved Schedule adherence, mostly in peak directions	(+)Some improved Schedule adherence at key intersections
Public Consultation		(++)Generally seen as the best option by the public	(++)Seen as a good option by the public overall	(++)Seen as a good option by the public overall	(+)Considered a good option	(+)Seen as a good option by the public	Generally perceived to be the least desirable option
Overall Evaluation		14	14	12	10	10	8

NOTES: 1. Score for other factors is the sum of the positive impacts less the negative impacts. Impacts with "+" or "++" receive double score.
2. Implementation cost for this option is expected to be similar for Option B1.2A

6 SUMMARY & RECOMMENDATIONS

6.1 SUMMARY

Recent and ongoing policy development efforts have made improvements to Halifax’s transit service a key priority for the Municipality. Specifically, Halifax Transit’s *Moving Forward Together Plan* (adopted by Regional Council in April 2016) includes bold moves that will aim to improve transit service levels through increased priority, enhanced reliability, and reduced travel time. The bold moves are being made in support of the following four Council-endorsed ‘*Moving Forward Principles*’:

1. Increase the proportion of resources allocated towards high ridership services.
2. Build a simplified transfer based system.
3. Invest in service quality and reliability.
4. Give transit increased priority in the transportation network.

Among the key initiatives that the Municipality is considering for transit upgrades are Transit Priority Measures (TPMs) – strategically located street and intersection upgrades that provide priority for the movement of buses. Building on HRM’s recent success of implementing TPMs at various locations, the Municipality is interested in investigating corridor-level transit priority upgrades that satisfy specific recommendations of the *Moving Forward Together Plan* including two “critical locations” that were identified for transit priority measures: **Bayers Road** and **Gottingen Street**.

To address this identified need for transit priority along these two corridors, options were developed and evaluated against the level of impact that they are expected to have on transit operation as well as on active transportation (AT), general traffic, parking, road safety, and implementation cost.

Following initial development of the options for each corridor, consultation was held to gather input from key stakeholders and community groups through several stakeholder meetings as well as from the overall public through one public open house for each corridor and through online consultation through the project’s Shape Your City website.

Options preparation included a significant data collection phase that included topographic survey, as well as obtaining and reviewing data on transit vehicle and ridership volumes, volumes of traffic, pedestrians, and bicycle, as well as the review of available collision records and consideration of public and stakeholder input. Analysis was completed to evaluate the identified options using criteria developed through discussion with HRM staff as well as the methodology presented in Appendix E of *Moving Forward Together* (Halifax Transit, 2016).

6.2 RECOMMENDATIONS

Based on the background review, public and stakeholder consultation, functional design, various analysis frameworks, and comparative analysis, the recommendations have been developed for consideration by HRM.

Consideration was given to the phasing of corridor improvements. A proposed implementation plan has been identified with recommendations presented as Priority A, B, or C where items in Priority 'A' should generally be considered during the earlier years of the Action Plan, with those in Priority 'C' considered in the later years.

6.2.1 RECOMMENDATIONS - GOTTINGEN STREET

1. HRM should complete a parking analysis to determine the level of parking utilization for the Gottingen Street spaces and potential areas on adjacent streets that can accommodate additional parking.
2. HRM should install Option G3 along the entire corridor between Cogswell Street and North Street. This involves the removal of parking during the AM and PM peak periods and is considered the low investment option. Although this option does not specifically provide transit priority along this corridor it is expected to offer benefit to traffic progression along this corridor and provide overall road safety benefit addressing noted existing collision trend with parked vehicles.
3. HRM should install the transit priority measure at the Cornwallis Street to provide a queue jump for northbound buses.
4. HRM should consider a trial period where some parking additional parking is removed around the Cornwallis intersection to gather information on the effectiveness of providing a longer transit queue jump.
5. In the future the transit lane could be extended along the length of the corridor and consideration given to pedestrian half-signals at key pedestrian crossings.

PRIORITY 'A'

- Complete a parking analysis of utilization of parking on adjacent streets to develop a strategy to offset loss of parking along the Gottingen Street corridor.
- Implement Option G-3 (Remove parking / loading during peak periods).
- Design and install northbound transit priority measure at Cornwallis Street intersection.
- Consider some additional parking restrictions surrounding the Cornwallis Street intersection to extend the transit lane to improve operations.
- Design pedestrian half signal at Uniacke Street intersection.

PRIORITY 'B'

- Install pedestrian half signal at Uniacke Street intersection.
- Design pedestrian half signal at Cunard Street intersection.

PRIORITY 'C'

- Install pedestrian half signal at Cunard Street intersection.
- Implement continuous northbound transit lane for the full corridor on a trial basis.

6.2.2 RECOMMENDATIONS – BAYERS ROAD

Segment 1 - Romans Avenue to Halifax Shopping Centre (HSC):

1. HRM should plan for the installation of one transit only lane in each direction. In addition to providing benefit to transit during the peak direction it is expected to offer safety benefits when compared to a reversing lane and use of time of day transit lane signage.

Segment 2 - Halifax Shopping Centre (HSC) to Connaught Avenue:

2. Although the high investment option at the HSC segment is expected to create significant benefit to transit and non-transit vehicles, there are expected to be significant issues to implementation that may make this option infeasible. In addition to cost, Option 1 (overpass) is expected to have significant impacts to property with significant retaining walls and grading challenges. Option 2A through this segment provides the best overall balance of the project objectives as it is expected to provide significant transit priority while considering the urban form through this area. HRM should seek to implement the medium investment option (Option 2A) through the HSC segment.

Segment 3 - Connaught Avenue to Windsor Street:

3. Connaught Avenue is considered a key intersection along this corridor and two westbound lanes for non-transit vehicles should be provided approaching Connaught Avenue for a distance of approximately 100 metres.
4. HRM should plan for the implementation of the high investment option (one continuous transit lane in each direction) through this segment.
5. Depending on construction timelines, a phased approach could be implemented where:
 - a. Road widening between Connaught Avenue and Connolly Street could provide the transit priority lanes and maintain the two westbound through lanes. This could be accompanied by signage and marking modifications east of Connolly to provide a westbound transit lane while maintaining existing road width.
 - b. Widening east of Connolly Street should be completed in a subsequent construction phase.

Segment 4 - Windsor Street Intersection:

6. In addition to providing transit priority in both directions, the high investment option is expected to offer benefits by modifying the right turn channels from Windsor Street to provide improved lane geometry and alignment at the intersection and provide improved lane balance with recommended improvements in Segment 3. HRM should plan for the implementation of this option.

PRIORITY 'A'

- Initiate acquisition of identified properties to implement Option B-1.2 (Medium investment through HSC segment, High investment otherwise).
- Design and implement modifications for continuous transit lanes in both directions for Romans Avenue to HSC.
- Design and implement modifications for Option 2A (Medium investment) through the HSC segment. This should include road widening that extends 100 metres east of Connaught Avenue to provide transit priority and two westbound approach lanes at that intersection.
- Consider modifications to provide a westbound transit lane (Option 3) between Windsor Street and Connolly Street.
- Design modifications at the Windsor Street intersection.

PRIORITY 'B'

- Implement modifications at the Windsor Street intersection.
- Design modifications to install a transit lane in each direction between Connaught Avenue and Windsor Street.

PRIORITY 'C'

- Implement modifications to provide a continuous transit lane in each direction between Connolly Street and Windsor Street.

APPENDIX

A FUNCTIONAL DESIGNS

A large, white, diagonal shape that resembles a stylized letter 'V' or a folded corner, positioned on the left side of the page, partially overlapping the text 'DESIGNS'.

Functional Designs
Are Included in the HRM Staff Report

APPENDIX

B

PUBLIC

CONSULTATION

FEEDBACK

FORMS

Public Consultation Feedback Forms
Are Included in the HRM Staff Report

APPENDIX

C ONLINE CONSULTATION RESULTS

Online Consultation Results
Are Included in the HRM Staff Report

APPENDIX

D COST ESTIMATES

A large, white, diagonal shape that resembles a stylized 'V' or a folded corner, positioned on the left side of the page, partially overlapping the text 'D COST ESTIMATES'.

HRM TRANSIT PRIORITY CORRIDORS - GOTTINGEN STREET

HIGH LEVEL ESTIMATE OF PROBABLE COSTS



PROJECT NO. 171-09619
 DATE: Jan. 15, 2018
 CLIENT: HRM
 CONSULTANT: WSP
 UNIT PRICE SOURCE: WSP

Disclaimer: This estimate of probable construction cost is approximate only. Actual cost may vary significantly from this estimate due to market conditions such as material and labour costs, time of year, industry workload, competition, etc. This estimate has been prepared based on our experience with similar projects. This estimate has not been prepared by obtaining any estimates or quotes from contractors. Due to the uncertainties of what contractors bid, WSP cannot make any assurances that this estimate will be within a reasonable range of the tendered low bid. When assessing this project for business feasibility purposes this estimate should not be relied upon without considering these factors.

NOTE:

1. HST NOT INCLUDED IN INDICATED UNIT PRICES AND TOTALS.
2. ESTIMATE BASED ON FUNCTIONAL DESIGN DRAWINGS PROVIDED FOR PUBLIC OPEN HOUSE ON OCT. 2, 2017.
3. ALL PRICES SHOWN ARE IN 2017 CANADIAN DOLLARS.
4. ESTIMATE DOES NOT INCLUDE ALLOWANCES FOR ENGINEERING, ADMINISTRATION OR INSPECTION FEES.
5. COSTS AND QUANTITIES ASSUME NO OTHER WORK IS BEING DONE IN CONJUNCTION WITH TRANSIT PRIORITY IMPROVEMENT MEASURES.
6. OPTION G3 (LOW INVESTMENT SCENARIO) IS NOT SHOWN SINCE THE ONLY COST IS FOR REPLACEMENT OF STOPPING / PARKING RESTRICTION SIGNS WHICH IS EXCLUDED FROM THESE ESTIMATES.

ITEM	DESCRIPTION	UNITS	UNIT PRICE	Option G1*		Option G2*	
				QNTY.	COST	QNTY.	COST

Sub-Total	\$231,100	\$209,800
Contingency (30%)	\$69,330	\$62,940
ESTIMATED COST (excl. HST)	\$300,000	\$273,000

***OPTIONS**

G1	Continuous Northbound Transit Lane
G2	NB Transit Priority at Key Intersections

APPENDIX

E SAMPLE DELAY AND PAYBACK CALCULATIONS

Using the Net User Delay Methodology developed in the *Transit Priority Measures Study* (WSP, 2016) as well the Transit ridership data and delay estimates obtained for each location it is possible to calculate the net road user delay during the subject peak hour as well as the payback periods associated with each measure. These equations are included below.

$$\text{Net Change in Road User Delay} = \text{Net Transit User Delay} + \text{Net Non Transit User Delay}$$

Where:

$$\text{Net Change in Transit User Delay} = \text{Delay/Transit Vehicle} \times \# \text{ Transit Vehicles} \times \text{Average Ridership per Transit Vehicle}$$

And,

$$\text{Net Change in Non Transit User Delay} = \text{Delay/Non Transit Vehicle} \times \# \text{ Non Transit Vehicles} \times \text{Average Vehicle Occupancy}$$

Note: Delay reductions will be a negative value while delay increases will be a positive value.

$$\text{Daily Change in Cost to Transit}$$

$$= \text{Average Change in Delay/Transit Vehicle} \times \# \text{ Transit Vehicles} \times \text{Cost/hour for Transit Vehicle}$$

$$\text{Annual Change in Cost to Transit} = \text{Daily Change in Cost to Transit} \times \text{Days/Year TPM is in Use}$$

$$\text{Daily Change in Cost to Public} = \text{Daily Change in Person Cost} + \text{Daily Change in nonTransit Vehicle Cost}$$

Where

$$\text{Daily Change in Person Cost}$$

$$= \text{Net Change in Road User Delay} \times \# \text{ hours TPM will be in effect per day} \times \text{Cost/hour for Road User}$$

$$\text{Daily Change in nonTransit Vehicle Cost}$$

$$= \text{Average delay change per nonTransit user} \times \# \text{ of NonTransit vehicles} \times \text{Cost /hour for nonTransit Vehicle}$$

$$\text{Annual Change in Cost to Public} = \text{Daily Change in Cost to Public} \times \text{Days/Year TPM is in Use}$$

$$\text{Payback Period} = \frac{\text{TPM Capital Cost}}{\text{Annual Cost Savings to Transit} + \text{Annual Cost Savings to Public} - \text{Annual Change in Operating Cost}}$$

APPENDIX

F

GOTTINGEN

STREET

INTERSECTION

CAPACITY

ANALYSIS

Table F-1 - Gottingen Street AM Peak Hour Intersection Analysis

Intersection		AM Peak Hour											
		Existing Conditions					Preferred Option						
		Scenario	Approach ¹	Delay	V/C	LOS	Queue	Option	Approach ¹	Delay	V/C	LOS	Queue
Gottingen Street @	North	Existing (Page F-2)	EB-LTR	49.7	0.90	D	85.2	High Invest ² (Page F-8)	EB-LTR	49.7	0.90	D	85.2
			WB-L	47.0	0.91	D	140.9		WB-L	47.0	0.91	D	140.9
			WB-T	23.7	0.69	C	129.8		WB-T	23.7	0.69	C	129.8
			WB-R	3.0	0.32	A	12.4		WB-R	3.0	0.32	A	12.4
			NB-T	23.1	0.36	C	40.0		NB-T	25.3	0.36	C	43.4
			NB-R	4.5	0.26	A	11.0		NB-R	7.3	0.26	A	13.9
			SB-L	53.0	0.87	D	83.1		SB-L	53.0	0.87	D	83.1
			SB-T	39.3	0.81	D	90.8		SB-LTR	39.3	0.81	D	90.8
	Cornwallis	Existing (Page F-3)	EB-LTR	40.8	0.72	D	81.6	High Invest ³ (Page F-9)	EB-TR	40.8	0.72	D	81.6
			WB-LTR	25.9	0.28	C	29.2		WB-LTR	29.9	0.29	C	31.8
			NB-LTR	7.6	0.22	A	24.7		NB-TL	7.6	0.18	A	21.2
			SB-LTR	21.6	0.82	C	164.8		NB-R	2.7	0.04	A	3.6
	Cogswell	Existing (Page F-4)	EB-LT	25.4	0.35	C	35.6	High Invest ⁴ (Page F-10)	EB-LT	25.4	0.35	C	35.6
			EB-R	2.5	0.14	A	3.6		EB-R	2.5	0.13	A	3.6
			WB-L	21.8	0.02	C	3.1		WB-L	21.8	0.02	C	3.1
			WB-T	23.8	0.18	C	24.0		WB-T	23.8	0.18	C	24.0
			WB-R	2.4	0.12	A	3.6		WB-R	2.4	0.12	A	3.6
			NB-L	12.6	0.34	B	22.9		NB-L	12.6	0.34	B	22.9
			NB-TR	11.0	0.15	B	17.6		NB-TR	11.0	0.15	B	17.6
			SB-L	24.8	0.47	C	48.8		SB-L	24.8	0.47	C	48.8
	SB-TR	25.0	0.55	C	72.0	SB-TR	25.0	0.55	C	72.0			

Notes:

1. Gottingen Street is north/south for the full corridor
2. Shortening of northbound right turn lane at North intersection to provide transit priority lane.
3. Provide northbound transit lane.
4. No Impact to Operations at this intersection

Table F-2 - Gottingen Street PM Peak Hour Intersection Analysis

Intersection		PM Peak Hour											
		Existing Conditions					Preferred Option						
		Scenario	Approach ¹	Delay	V/C	LOS	Queue	Option	Approach ¹	Delay	V/C	LOS	Queue
Gottingen Street @	North	Existing (Page F-5)	EB-LTR	85.4	0.94	F	97.6	High Invest ² (Page F-11)	EB-LTR	85.4	0.94	F	97.6
			WB-L	48.7	0.89	D	72.4		WB-L	48.7	0.89	D	72.4
			WB-T	32.1	0.77	C	129.3		WB-T	32.1	0.77	C	129.3
			WB-R	8.8	0.64	A	41.7		WB-R	8.8	0.64	A	41.7
			NB-T	45.0	0.79	D	99.2		NB-T	70.1	0.79	D	96.6
			NB-R	61.1	0.99	E	123.6		NB-R	54.5	0.99	D	119.9
			SB-L	23.7	0.66	C	39.2		SB-L	23.7	0.66	C	39.2
			SB-T	17.0	0.37	B	40.9		SB-TR	17.0	0.37	B	40.9
	Cornwallis	Existing (Page F-6)	EB-LTR	25.1	0.36	C	35.8	High Invest ³ (Page F-12)	EB-TR	25.1	0.36	C	35.8
			WB-LTR	27.3	0.53	C	65.6		WB-LTR	29.4	0.55	C	69.1
			NB-LTR	17.7	0.62	B	96.0		NB-LT	15.3	0.52	B	76.6
			SB-LTR	14.4	0.58	B	54.4		NB-R	6.0	0.08	A	8.6
	Cogswell	Existing (Page F-7)	EB-LT	28.2	0.35	C	29.9	High Invest ⁴ (Page F-13)	EB-LT	28.2	0.35	C	29.9
			EB-R	2.2	0.12	A	2.4		EB-R	2.2	0.12	A	2.4
			WB-L	24.6	0.04	C	5.3		WB-L	24.6	0.04	C	5.3
			WB-T	34.5	0.59	C	73.3		WB-T	34.5	0.59	C	73.3
			WB-R	6.2	0.33	A	12.6		WB-R	6.2	0.33	A	12.6
			NB-L	25.9	0.79	C	72.5		NB-L	25.9	0.79	C	72.5
			NB-TR	15.3	0.43	B	52.5		NB-TR	15.3	0.43	B	52.5
			SB-L	23.2	0.25	C	21.9		SB-L	23.2	0.25	C	21.9
	SB-TR	22.0	0.39	C	46.5	SB-TR	22.0	0.39	C	46.5			

Notes:

1. Gottingen Street is north/south for the full corridor
2. Shortening of northbound right turn lane at North intersection to provide transit priority lane.
3. Provide northbound transit lane.
4. No Impact to Operations at this intersection

Halifax Transit Priority Corridors 1: Gottingen Street & North Street

Lane Group	EBL	EBT	EBR	WBL	WBT	WBR	NBL	NBT	NBR	SBL	SBT	SBR
Lane Configurations												
Traffic Volume (vph)	5	440	25	475	595	255	0	195	140	280	375	15
Future Volume (vph)	5	440	25	475	595	255	0	195	140	280	375	15
Satd. Flow (prot)	0	2785	0	1639	1736	1467	0	1680	1428	1578	1482	0
Flt Permitted		0.946		0.187						0.613		
Satd. Flow (perm)	0	2636	0	309	1736	1361	0	1680	1360	991	1482	0
Satd. Flow (RTOR)		4				266			146		3	
Lane Group Flow (vph)	0	489	0	495	620	266	0	203	146	292	407	0
Turn Type	Perm	NA		pm+pt	NA	Perm		NA	Perm	Perm	NA	
Protected Phases		8		7	4			6			2	
Permitted Phases	8			4		4			6	2		
Total Split (s)	25.0	25.0		23.0	48.0	48.0		42.0	42.0	42.0	42.0	
Total Lost Time (s)		6.3		3.0	6.3	6.3		6.7	6.7	6.7	6.7	
Act Effct Green (s)		18.4		49.7	46.4	46.4		30.6	30.6	30.6	30.6	
Actuated g/C Ratio		0.20		0.55	0.52	0.52		0.34	0.34	0.34	0.34	
v/c Ratio		0.90		0.91	0.69	0.32		0.36	0.26	0.87	0.81	
Control Delay		49.7		47.0	23.1	3.0		23.1	4.5	53.0	39.3	
Queue Delay		0.0		0.0	0.6	0.0		0.0	0.0	0.0	0.0	
Total Delay		49.7		47.0	23.7	3.0		23.1	4.5	53.0	39.3	
LOS		D		D	C	A		C	A	D	D	
Approach Delay		49.7			28.0			15.3			45.0	
Approach LOS		D			C			B			D	
Queue Length 50th (m)		30.2		~71.2	81.9	0.0		24.8	0.0	44.4	59.7	
Queue Length 95th (m)		#85.2		#140.9	129.8	12.4		40.0	11.0	#83.1	90.8	
Internal Link Dist (m)		72.5			71.6			146.8			484.7	
Turn Bay Length (m)										60.0		
Base Capacity (vph)		550		541	895	831		658	622	388	583	
Starvation Cap Reductn		0		0	68	0		0	0	0	0	
Spillback Cap Reductn		0		0	0	0		0	0	0	0	
Storage Cap Reductn		0		0	0	0		0	0	0	0	
Reduced v/c Ratio		0.89		0.91	0.75	0.32		0.31	0.23	0.75	0.70	

Intersection Summary

Cycle Length: 90
 Actuated Cycle Length: 90
 Offset: 0 (0%), Referenced to phase 2:SBTL and 6:NBT, Start of Green
 Control Type: Actuated-Coordinated
 Maximum v/c Ratio: 0.91
 Intersection Signal Delay: 34.2
 Intersection Capacity Utilization 115.8%
 Analysis Period (min) 15
 ~ Volume exceeds capacity, queue is theoretically infinite.
 Queue shown is maximum after two cycles.
 # 95th percentile volume exceeds capacity, queue may be longer.
 Queue shown is maximum after two cycles.

Splits and Phases: 1: Gottingen Street & North Street

Ø2 (R)	Ø4
42 s	48 s
Ø5 (R)	Ø7
42 s	23 s
	Ø8
	25 s

Lane Group	EBL	EBT	EBR	WBL	WBT	WBR	NBL	NBT	NBR	SBL	SBT	SBR
Lane Configurations												
Traffic Volume (vph)	25	215	40	10	75	25	5	185	15	60	650	40
Future Volume (vph)	25	215	40	10	75	25	5	185	15	60	650	40
Satd. Flow (prot)	0	1800	0	0	1778	0	0	1679	0	0	1679	0
Flt Permitted		0.963			0.962			0.982			0.955	
Satd. Flow (perm)	0	1740	0	0	1717	0	0	1650	0	0	1609	0
Satd. Flow (RTOR)		9			16			9			6	
Lane Group Flow (vph)	0	311	0	0	122	0	0	229	0	0	833	0
Turn Type	Perm	NA		Perm	NA		Perm	NA		Perm	NA	
Protected Phases		4			4			2			2	
Permitted Phases	4			4			2			2		
Total Split (s)	28.0	28.0		28.0	28.0		62.0	62.0		62.0	62.0	
Total Lost Time (s)		5.9			5.9			5.5			5.5	
Act Effct Green (s)		22.1			22.1			56.5			56.5	
Actuated g/C Ratio		0.25			0.25			0.63			0.63	
v/c Ratio		0.72			0.28			0.22			0.82	
Control Delay		40.8			25.9			7.6			21.6	
Queue Delay		0.0			0.0			0.0			0.0	
Total Delay		40.8			25.9			7.6			21.6	
LOS		D			C			A			C	
Approach Delay		40.8			25.9			7.6			21.6	
Approach LOS		D			C			A			C	
Queue Length 50th (m)		47.9			14.8			14.8			99.6	
Queue Length 95th (m)		#81.6			29.2			24.7			#164.8	
Internal Link Dist (m)		133.8			116.8			279.1			419.4	
Turn Bay Length (m)												
Base Capacity (vph)		434			433			1039			1012	
Starvation Cap Reductn		0			0			0			0	
Spillback Cap Reductn		0			0			0			0	
Storage Cap Reductn		0			0			0			0	
Reduced v/c Ratio		0.72			0.28			0.22			0.82	

Intersection Summary

Cycle Length: 90
 Actuated Cycle Length: 90
 Offset: 0 (0%), Referenced to phase 2:NBSB, Start of Green
 Control Type: Pretimed
 Maximum v/c Ratio: 0.82
 Intersection Signal Delay: 23.8
 Intersection Capacity Utilization 84.8%
 Analysis Period (min) 15
 # 95th percentile volume exceeds capacity, queue may be longer.
 Queue shown is maximum after two cycles.

Splits and Phases: 2: Gottingen Street & Cornwallis Street

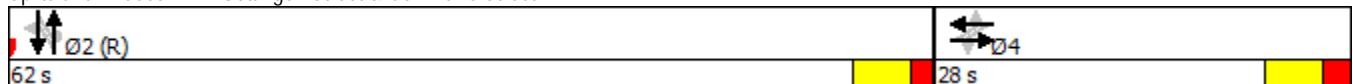

Halifax Transit Priority Corridors 3: Gottingen Street & Cogswell Street

Lane Group	EBL	EBT	EBR	WBL	WBT	WBR	NBL	NBT	NBR	SBL	SBT	SBR
Lane Configurations												
Traffic Volume (vph)	20	295	55	5	90	55	145	90	15	200	280	40
Future Volume (vph)	20	295	55	5	90	55	145	90	15	200	280	40
Satd. Flow (prot)	0	3140	1362	1575	1658	1409	1575	1384	0	1575	1504	0
Flt Permitted		0.934		0.546			0.427			0.685		
Satd. Flow (perm)	0	2932	1174	837	1658	1291	692	1384	0	1112	1504	0
Satd. Flow (RTOR)			94			94		13			9	
Lane Group Flow (vph)	0	335	59	5	96	59	154	112	0	213	341	0
Turn Type	Perm	NA	Perm	Perm	NA	Perm	pm+pt	NA		Perm	NA	
Protected Phases		4			4		1	6			2	
Permitted Phases	4		4	4		4	6			2		
Total Split (s)	38.0	38.0	38.0	38.0	38.0	38.0	11.0	57.0		46.0	46.0	
Total Lost Time (s)		6.7	6.7	6.7	6.7	6.7	4.0	7.2		7.2	7.2	
Act Effct Green (s)		31.3	31.3	31.3	31.3	31.3	53.0	49.8		38.8	38.8	
Actuated g/C Ratio		0.33	0.33	0.33	0.33	0.33	0.56	0.52		0.41	0.41	
v/c Ratio		0.35	0.13	0.02	0.18	0.12	0.34	0.15		0.47	0.55	
Control Delay		25.4	2.5	21.8	23.8	2.4	12.6	11.0		24.8	25.0	
Queue Delay		0.0	0.0	0.0	0.0	0.0	0.0	0.0		0.0	0.0	
Total Delay		25.4	2.5	21.8	23.8	2.4	12.6	11.0		24.8	25.0	
LOS		C	A	C	C	A	B	B		C	C	
Approach Delay		22.0			15.9			11.9			24.9	
Approach LOS		C			B			B			C	
Queue Length 50th (m)		24.2	0.0	0.6	12.4	0.0	13.0	8.8		28.0	45.4	
Queue Length 95th (m)		35.6	3.6	3.1	24.0	3.6	22.9	17.6		48.8	72.0	
Internal Link Dist (m)		66.6			131.0			105.8			279.1	
Turn Bay Length (m)			30.0			50.0	50.0			50.0		
Base Capacity (vph)		966	449	275	546	488	451	731		454	619	
Starvation Cap Reductn		0	0	0	0	0	0	0		0	0	
Spillback Cap Reductn		0	0	0	0	0	0	0		0	0	
Storage Cap Reductn		0	0	0	0	0	0	0		0	0	
Reduced v/c Ratio		0.35	0.13	0.02	0.18	0.12	0.34	0.15		0.47	0.55	

Intersection Summary

Cycle Length: 95
 Actuated Cycle Length: 95
 Offset: 6 (6%), Referenced to phase 2:SBTL and 6:NBTL, Start of Green
 Control Type: Actuated-Coordinated
 Maximum v/c Ratio: 0.55
 Intersection Signal Delay: 20.5
 Intersection Capacity Utilization 98.0%
 Analysis Period (min) 15

Intersection LOS: C
 ICU Level of Service F

Splits and Phases: 3: Gottingen Street & Cogswell Street

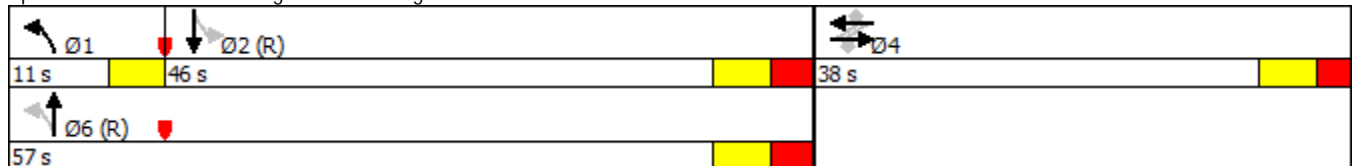

Halifax Transit Priority Corridors 1: Gottingen Street & North Street

Lane Group	EBL	EBT	EBR	WBL	WBT	WBR	NBL	NBT	NBR	SBL	SBT	SBR
Lane Configurations												
Traffic Volume (vph)	15	645	15	245	495	445	0	335	530	230	195	20
Future Volume (vph)	15	645	15	245	495	445	0	335	530	230	195	20
Satd. Flow (prot)	0	3589	0	1655	1749	1481	0	1339	1062	1580	1383	0
Flt Permitted		0.934		0.167						0.365		
Satd. Flow (perm)	0	3353	0	277	1749	1331	0	1339	1019	598	1383	0
Satd. Flow (RTOR)		2				379			356		8	
Lane Group Flow (vph)	0	733	0	266	538	484	0	364	576	250	234	0
Turn Type	Perm	NA		pm+pt	NA	Perm		NA	Perm	pm+pt	NA	
Protected Phases		8		7	4			6		5	2	
Permitted Phases	8			4		4			6	2		
Total Split (s)	27.0	27.0		14.0	41.0	41.0		39.0	39.0	10.0	49.0	
Total Lost Time (s)		6.3		3.0	6.3	6.3		6.7	6.7	3.0	6.7	
Act Effct Green (s)		21.0		39.1	35.8	35.8		31.1	31.1	44.9	41.2	
Actuated g/C Ratio		0.23		0.43	0.40	0.40		0.35	0.35	0.50	0.46	
v/c Ratio		0.94		0.89	0.77	0.64		0.79	0.99	0.66	0.37	
Control Delay		40.5		48.7	32.1	8.8		45.0	53.8	23.7	17.0	
Queue Delay		44.9		0.0	0.0	0.0		0.0	7.3	0.0	0.0	
Total Delay		85.4		48.7	32.1	8.8		45.0	61.1	23.7	17.0	
LOS		F		D	C	A		D	E	C	B	
Approach Delay		85.4			26.8			54.9			20.5	
Approach LOS		F			C			D			C	
Queue Length 50th (m)		52.7		31.3	82.0	13.5		63.6	64.6	23.8	23.8	
Queue Length 95th (m)		#97.6		m#72.4	m#129.3	m41.7		#99.2	#123.6	39.2	40.9	
Internal Link Dist (m)		72.5			71.6			338.4			95.8	
Turn Bay Length (m)									300.0	60.0		
Base Capacity (vph)		782		300	695	757		480	593	376	654	
Starvation Cap Reductn		0		0	0	0		0	0	0	0	
Spillback Cap Reductn		144		0	0	0		0	20	0	0	
Storage Cap Reductn		0		0	0	0		0	0	0	0	
Reduced v/c Ratio		1.15		0.89	0.77	0.64		0.76	1.01	0.66	0.36	

Intersection Summary

Cycle Length: 90
 Actuated Cycle Length: 90
 Offset: 17 (19%), Referenced to phase 2:SBTL and 6:NBT, Start of Green
 Control Type: Actuated-Coordinated
 Maximum v/c Ratio: 0.99
 Intersection Signal Delay: 46.0
 Intersection Capacity Utilization 106.5%
 Analysis Period (min) 15
 # 95th percentile volume exceeds capacity, queue may be longer.
 Queue shown is maximum after two cycles.
 m Volume for 95th percentile queue is metered by upstream signal.

Splits and Phases: 1: Gottingen Street & North Street

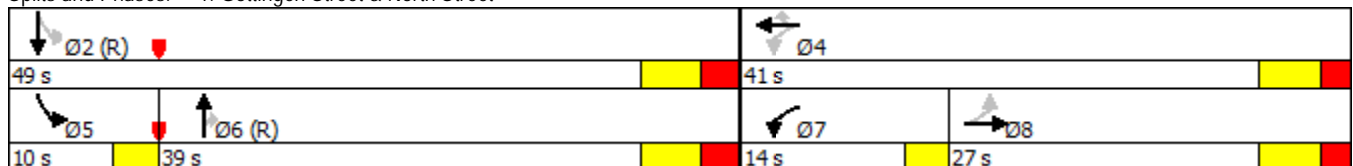

Lane Group	EBL	EBT	EBR	WBL	WBT	WBR	NBL	NBT	NBR	SBL	SBT	SBR
Lane Configurations												
Traffic Volume (vph)	55	70	15	10	200	70	20	480	10	35	365	45
Future Volume (vph)	55	70	15	10	200	70	20	480	10	35	365	45
Satd. Flow (prot)	0	1780	0	0	1776	0	0	1689	0	0	1667	0
Flt Permitted		0.735			0.989			0.973			0.930	
Satd. Flow (perm)	0	1334	0	0	1760	0	0	1646	0	0	1556	0
Satd. Flow (RTOR)		7			20			2			10	
Lane Group Flow (vph)	0	156	0	0	311	0	0	566	0	0	495	0
Turn Type	Perm	NA		Perm	NA		Perm	NA		Perm	NA	
Protected Phases		4			4			2			2	
Permitted Phases	4			4			2			2		
Total Split (s)	35.0	35.0		35.0	35.0		55.0	55.0		55.0	55.0	
Total Lost Time (s)		5.9			5.9			5.5			5.5	
Act Effct Green (s)		29.1			29.1			49.5			49.5	
Actuated g/C Ratio		0.32			0.32			0.55			0.55	
v/c Ratio		0.36			0.53			0.62			0.58	
Control Delay		25.1			27.3			17.7			14.4	
Queue Delay		0.0			0.0			0.0			0.0	
Total Delay		25.1			27.3			17.7			14.4	
LOS		C			C			B			B	
Approach Delay		25.1			27.3			17.7			14.4	
Approach LOS		C			C			B			B	
Queue Length 50th (m)		19.5			40.7			62.6			42.8	
Queue Length 95th (m)		35.8			65.6			96.0			m54.4	
Internal Link Dist (m)		136.3			95.8			282.9			131.2	
Turn Bay Length (m)												
Base Capacity (vph)		436			582			906			860	
Starvation Cap Reductn		0			0			0			0	
Spillback Cap Reductn		0			0			0			0	
Storage Cap Reductn		0			0			0			0	
Reduced v/c Ratio		0.36			0.53			0.62			0.58	

Intersection Summary

Cycle Length: 90
 Actuated Cycle Length: 90
 Offset: 0 (0%), Referenced to phase 2:NBSB, Start of Green
 Control Type: Pretimed
 Maximum v/c Ratio: 0.62
 Intersection Signal Delay: 19.3
 Intersection Capacity Utilization 73.4%
 Analysis Period (min) 15
 m Volume for 95th percentile queue is metered by upstream signal.

Intersection LOS: B
 ICU Level of Service D

Splits and Phases: 2: Gottingen Street & Cornwallis Street

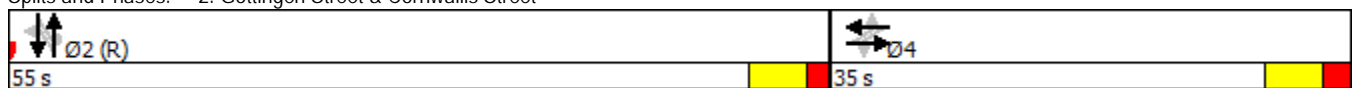

Halifax Transit Priority Corridors

3: Gottingen Street & Cogswell Street

Lane Group	EBL	EBT	EBR	WBL	WBT	WBR	NBL	NBT	NBR	SBL	SBT	SBR
Lane Configurations												
Traffic Volume (vph)	50	175	45	10	265	140	400	270	15	75	145	60
Future Volume (vph)	50	175	45	10	265	140	400	270	15	75	145	60
Satd. Flow (prot)	0	3139	1362	1575	1658	1409	1575	1394	0	1550	1532	0
Flt Permitted		0.748		0.592			0.526			0.563		
Satd. Flow (perm)	0	2338	1217	921	1658	1215	848	1394	0	895	1532	0
Satd. Flow (RTOR)			89			161		4			24	
Lane Group Flow (vph)	0	258	52	11	305	161	460	327	0	86	236	0
Turn Type	Perm	NA	Perm	Perm	NA	Perm	pm+pt	NA		Perm	NA	
Protected Phases		4			4		1	6			2	
Permitted Phases	4		4	4		4	6			2		
Total Split (s)	38.0	38.0	38.0	38.0	38.0	38.0	16.0	62.0		46.0	46.0	
Total Lost Time (s)		6.7	6.7	6.7	6.7	6.7	4.0	7.2		7.2	7.2	
Act Effct Green (s)		31.3	31.3	31.3	31.3	31.3	58.0	54.8		38.8	38.8	
Actuated g/C Ratio		0.31	0.31	0.31	0.31	0.31	0.58	0.55		0.39	0.39	
v/c Ratio		0.35	0.12	0.04	0.59	0.33	0.79	0.43		0.25	0.39	
Control Delay		28.2	2.2	24.6	34.5	6.2	25.9	15.3		23.2	22.0	
Queue Delay		0.0	0.0	0.0	0.0	0.0	0.0	0.0		0.0	0.0	
Total Delay		28.2	2.2	24.6	34.5	6.2	25.9	15.3		23.2	22.0	
LOS		C	A	C	C	A	C	B		C	C	
Approach Delay		23.9			24.7			21.5			22.3	
Approach LOS		C			C			C			C	
Queue Length 50th (m)		20.2	0.0	1.5	49.5	0.0	49.5	34.9		11.1	28.9	
Queue Length 95th (m)		29.9	2.4	5.3	73.3	12.6	#72.5	52.5		21.9	46.5	
Internal Link Dist (m)		66.6			100.9			105.8			282.9	
Turn Bay Length (m)			30.0			50.0	50.0			50.0		
Base Capacity (vph)		731	442	288	518	490	579	765		347	609	
Starvation Cap Reductn		0	0	0	0	0	0	0		0	0	
Spillback Cap Reductn		0	0	0	0	0	0	0		0	0	
Storage Cap Reductn		0	0	0	0	0	0	0		0	0	
Reduced v/c Ratio		0.35	0.12	0.04	0.59	0.33	0.79	0.43		0.25	0.39	

Intersection Summary

Cycle Length: 100
 Actuated Cycle Length: 100
 Offset: 17 (17%), Referenced to phase 2:SBTL and 6:NBTL, Start of Green
 Control Type: Actuated-Coordinated
 Maximum v/c Ratio: 0.79
 Intersection Signal Delay: 22.8
 Intersection Capacity Utilization 117.0%
 Analysis Period (min) 15
 # 95th percentile volume exceeds capacity, queue may be longer.
 Queue shown is maximum after two cycles.

Splits and Phases: 3: Gottingen Street & Cogswell Street

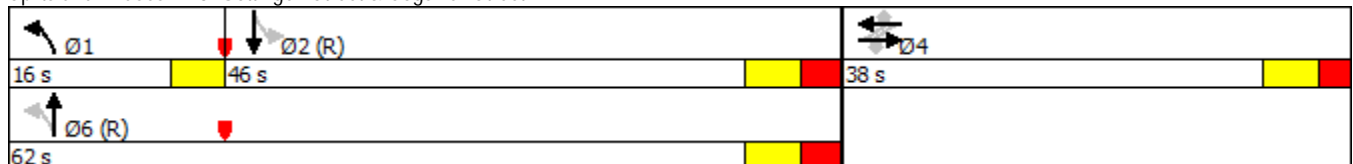

Halifax Transit Priority Corridors 1: Gottingen Street & North Street

Lane Group	EBL	EBT	WBL	WBT	WBR	NBT	NBR	SBL	SBT
Lane Configurations									
Traffic Volume (vph)	5	440	475	595	255	195	140	280	375
Future Volume (vph)	5	440	475	595	255	195	140	280	375
Lane Group Flow (vph)	0	489	495	620	266	203	146	292	407
Turn Type	Perm	NA	pm+pt	NA	Perm	NA	Perm	Perm	NA
Protected Phases		8	7	4		6			2
Permitted Phases	8		4		4		6	2	
Detector Phase	8	8	7	4	4	6	6	2	2
Switch Phase									
Minimum Initial (s)	10.0	10.0	7.0	10.0	10.0	10.0	10.0	10.0	10.0
Minimum Split (s)	25.0	25.0	10.0	48.0	48.0	42.0	42.0	42.0	42.0
Total Split (s)	25.0	25.0	23.0	48.0	48.0	42.0	42.0	42.0	42.0
Total Split (%)	27.8%	27.8%	25.6%	53.3%	53.3%	46.7%	46.7%	46.7%	46.7%
Yellow Time (s)	4.1	4.1	3.0	4.1	4.1	4.1	4.1	4.1	4.1
All-Red Time (s)	2.2	2.2	0.0	2.2	2.2	2.6	2.6	2.6	2.6
Lost Time Adjust (s)		0.0	0.0	0.0	0.0	0.0	0.0	0.0	0.0
Total Lost Time (s)		6.3	3.0	6.3	6.3	6.7	6.7	6.7	6.7
Lead/Lag	Lag	Lag	Lead						
Lead-Lag Optimize?									
Recall Mode	None	None	None	None	None	C-Min	C-Min	C-Min	C-Min
Act Effct Green (s)		18.4	49.7	46.4	46.4	30.6	30.6	30.6	30.6
Actuated g/C Ratio		0.20	0.55	0.52	0.52	0.34	0.34	0.34	0.34
v/c Ratio		0.90	0.91	0.69	0.32	0.36	0.26	0.87	0.81
Control Delay		49.7	47.0	23.1	3.0	25.3	7.3	53.0	39.3
Queue Delay		0.0	0.0	0.6	0.0	0.0	0.0	0.0	0.0
Total Delay		49.7	47.0	23.7	3.0	25.3	7.3	53.0	39.3
LOS		D	D	C	A	C	A	D	D
Approach Delay		49.7		28.0		17.8			45.0
Approach LOS		D		C		B			D
Queue Length 50th (m)		30.2	-71.2	81.9	0.0	26.8	0.0	44.4	59.7
Queue Length 95th (m)		#85.2	#140.9	129.8	12.4	m43.4	m13.9	#83.1	90.8
Internal Link Dist (m)		72.5		71.6		146.8			484.7
Turn Bay Length (m)							60.0		
Base Capacity (vph)		550	541	895	831	658	622	388	583
Starvation Cap Reductn		0	0	68	0	0	0	0	0
Spillback Cap Reductn		0	0	0	0	0	0	0	0
Storage Cap Reductn		0	0	0	0	0	0	0	0
Reduced v/c Ratio		0.89	0.91	0.75	0.32	0.31	0.23	0.75	0.70

Intersection Summary

Cycle Length: 90
 Actuated Cycle Length: 90
 Offset: 0 (0%), Referenced to phase 2:SBTL and 6:NBT, Start of Green
 Natural Cycle: 90
 Control Type: Actuated-Coordinated
 Maximum v/c Ratio: 0.91
 Intersection Signal Delay: 34.5
 Intersection Capacity Utilization 115.8%
 Analysis Period (min) 15
 ~ Volume exceeds capacity, queue is theoretically infinite.
 Queue shown is maximum after two cycles.
 # 95th percentile volume exceeds capacity, queue may be longer.
 Queue shown is maximum after two cycles.
 m Volume for 95th percentile queue is metered by upstream signal.

Splits and Phases: 1: Gottingen Street & North Street

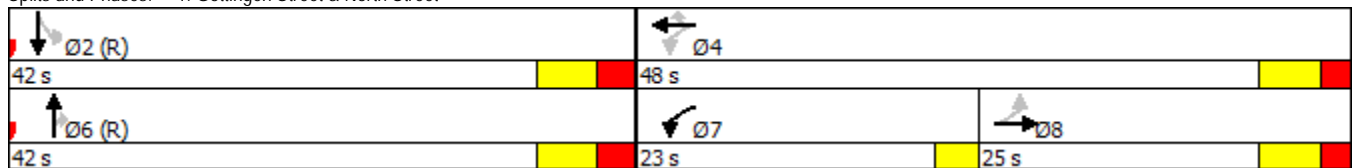

Halifax Transit Priority Corridors

2: Gottingen Street & Cornwallis Street

Lane Group	EBL2	EBT	WBL	WBT	NBL	NBT	NBR	SBL	SBT
Lane Configurations									
Traffic Volume (vph)	25	215	10	75	5	165	20	60	650
Future Volume (vph)	25	215	10	75	5	165	20	60	650
Lane Group Flow (vph)	0	311	0	122	0	189	39	0	833
Turn Type	Perm	NA	Perm	NA	Perm	NA	Perm	Perm	NA
Protected Phases		4		4		2			2
Permitted Phases	4		4		2		2	2	
Minimum Split (s)	28.0	28.0	28.0	28.0	28.0	28.0	28.0	28.0	28.0
Total Split (s)	28.0	28.0	28.0	28.0	62.0	62.0	62.0	62.0	62.0
Total Split (%)	31.1%	31.1%	31.1%	31.1%	68.9%	68.9%	68.9%	68.9%	68.9%
Yellow Time (s)	3.9	3.9	3.9	3.9	3.9	3.9	3.9	3.9	3.9
All-Red Time (s)	2.0	2.0	2.0	2.0	1.6	1.6	1.6	1.6	1.6
Lost Time Adjust (s)		0.0		0.0		0.0			0.0
Total Lost Time (s)		5.9		5.9		5.5			5.5
Lead/Lag									
Lead-Lag Optimize?									
Act Effct Green (s)		22.1		22.1		56.5		56.5	56.5
Actuated g/C Ratio		0.25		0.25		0.63		0.63	0.63
v/c Ratio		0.72		0.29		0.18		0.04	0.82
Control Delay		40.8		29.9		7.6		2.7	24.0
Queue Delay		0.0		0.0		0.0		0.0	0.0
Total Delay		40.8		29.9		7.6		2.7	24.0
LOS		D		C		A		A	C
Approach Delay		40.8		29.9		6.7			24.0
Approach LOS		D		C		A			C
Queue Length 50th (m)		47.9		17.2		12.4		0.3	140.7
Queue Length 95th (m)		#81.6		31.8		21.2		3.6	m171.5
Internal Link Dist (m)		133.8		116.8		279.1			419.4
Turn Bay Length (m)								85.0	
Base Capacity (vph)		434		421		1043		996	1016
Starvation Cap Reductn		0		0		0		0	0
Spillback Cap Reductn		0		0		0		0	0
Storage Cap Reductn		0		0		0		0	0
Reduced v/c Ratio		0.72		0.29		0.18		0.04	0.82

Intersection Summary

Cycle Length: 90
 Actuated Cycle Length: 90
 Offset: 0 (0%), Referenced to phase 2:NBSB, Start of Green
 Natural Cycle: 75
 Control Type: Pretimed
 Maximum v/c Ratio: 0.82
 Intersection Signal Delay: 25.3
 Intersection Capacity Utilization 82.8%
 Analysis Period (min) 15
 # 95th percentile volume exceeds capacity, queue may be longer.
 Queue shown is maximum after two cycles.
 m Volume for 95th percentile queue is metered by upstream signal.

Intersection LOS: C
 ICU Level of Service E

Splits and Phases: 2: Gottingen Street & Cornwallis Street

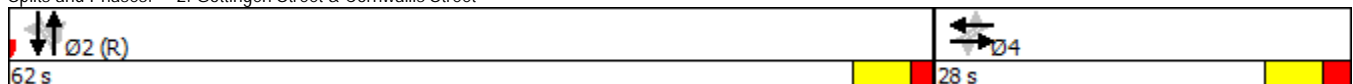

Halifax Transit Priority Corridors

3: Gottingen Street & Cogswell Street

Lane Group	EBL	EBT	EBR	WBL	WBT	WBR	NBL	NBT	SBL	SBT
Lane Configurations										
Traffic Volume (vph)	20	295	55	5	90	55	145	90	200	280
Future Volume (vph)	20	295	55	5	90	55	145	90	200	280
Lane Group Flow (vph)	0	335	59	5	96	59	154	112	213	341
Turn Type	Perm	NA	Perm	Perm	NA	Perm	pm+pt	NA	Perm	NA
Protected Phases		4			4		1	6		2
Permitted Phases	4		4	4		4	6		2	
Detector Phase	4	4		4	4		1	6	2	2
Switch Phase										
Minimum Initial (s)	7.0	7.0	7.0	7.0	7.0	7.0	7.0	7.0	7.0	7.0
Minimum Split (s)	36.7	36.7	36.7	36.7	36.7	36.7	11.0	44.2	44.2	44.2
Total Split (s)	38.0	38.0	38.0	38.0	38.0	38.0	11.0	57.0	46.0	46.0
Total Split (%)	40.0%	40.0%	40.0%	40.0%	40.0%	40.0%	11.6%	60.0%	48.4%	48.4%
Yellow Time (s)	4.1	4.1	4.1	4.1	4.1	4.1	4.0	4.1	4.1	4.1
All-Red Time (s)	2.6	2.6	2.6	2.6	2.6	2.6	0.0	3.1	3.1	3.1
Lost Time Adjust (s)		0.0	0.0	0.0	0.0	0.0	0.0	0.0	0.0	0.0
Total Lost Time (s)		6.7	6.7	6.7	6.7	6.7	4.0	7.2	7.2	7.2
Lead/Lag							Lead		Lag	Lag
Lead-Lag Optimize?										
Recall Mode	Max	Max	Max	Max	Max	Max	Max	C-Max	C-Max	C-Max
Act Effct Green (s)		31.3	31.3	31.3	31.3	31.3	53.0	49.8	38.8	38.8
Actuated g/C Ratio		0.33	0.33	0.33	0.33	0.33	0.56	0.52	0.41	0.41
v/c Ratio		0.35	0.13	0.02	0.18	0.12	0.34	0.15	0.47	0.55
Control Delay		25.4	2.5	21.8	23.8	2.4	12.6	11.0	24.8	25.0
Queue Delay		0.0	0.0	0.0	0.0	0.0	0.0	0.0	0.0	0.0
Total Delay		25.4	2.5	21.8	23.8	2.4	12.6	11.0	24.8	25.0
LOS		C	A	C	C	A	B	B	C	C
Approach Delay		22.0			15.9			11.9		24.9
Approach LOS		C			B			B		C
Queue Length 50th (m)		24.2	0.0	0.6	12.4	0.0	13.0	8.8	28.0	45.4
Queue Length 95th (m)		35.6	3.6	3.1	24.0	3.6	22.9	17.6	48.8	72.0
Internal Link Dist (m)		66.6			131.0			105.8		279.1
Turn Bay Length (m)			30.0			50.0	50.0		50.0	
Base Capacity (vph)		966	449	275	546	488	451	731	454	619
Starvation Cap Reductn		0	0	0	0	0	0	0	0	0
Spillback Cap Reductn		0	0	0	0	0	0	0	0	0
Storage Cap Reductn		0	0	0	0	0	0	0	0	0
Reduced v/c Ratio		0.35	0.13	0.02	0.18	0.12	0.34	0.15	0.47	0.55

Intersection Summary

Cycle Length: 95
 Actuated Cycle Length: 95
 Offset: 6 (6%), Referenced to phase 2:SBTL and 6:NBTL, Start of Green
 Natural Cycle: 95
 Control Type: Actuated-Coordinated
 Maximum v/c Ratio: 0.55
 Intersection Signal Delay: 20.5
 Intersection Capacity Utilization 98.0%
 Analysis Period (min) 15

Intersection LOS: C
 ICU Level of Service F

Splits and Phases: 3: Gottingen Street & Cogswell Street

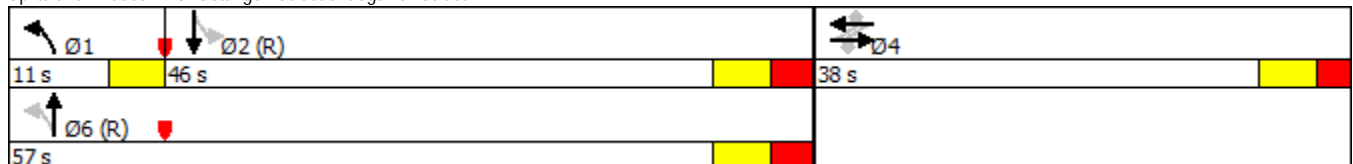

Halifax Transit Priority Corridors 1: Gottingen Street & North Street

Lane Group	EBL	EBT	WBL	WBT	WBR	NBT	NBR	SBL	SBT
Lane Configurations									
Traffic Volume (vph)	15	645	245	495	445	335	530	230	195
Future Volume (vph)	15	645	245	495	445	335	530	230	195
Lane Group Flow (vph)	0	733	266	538	484	364	576	250	234
Turn Type	Perm	NA	pm+pt	NA	Perm	NA	Perm	pm+pt	NA
Protected Phases		8	7	4		6		5	2
Permitted Phases	8		4		4		6	2	
Detector Phase	8	8	7	4	4	6	6	5	2
Switch Phase									
Minimum Initial (s)	10.0	10.0	7.0	10.0	10.0	10.0	10.0	7.0	10.0
Minimum Split (s)	27.0	27.0	10.0	41.0	41.0	39.0	39.0	10.0	49.0
Total Split (s)	27.0	27.0	14.0	41.0	41.0	39.0	39.0	10.0	49.0
Total Split (%)	30.0%	30.0%	15.6%	45.6%	45.6%	43.3%	43.3%	11.1%	54.4%
Yellow Time (s)	4.1	4.1	3.0	4.1	4.1	4.1	4.1	3.0	4.1
All-Red Time (s)	2.2	2.2	0.0	2.2	2.2	2.6	2.6	0.0	2.6
Lost Time Adjust (s)		0.0	0.0	0.0	0.0	0.0	0.0	0.0	0.0
Total Lost Time (s)		6.3	3.0	6.3	6.3	6.7	6.7	3.0	6.7
Lead/Lag	Lag	Lag	Lead			Lag	Lag	Lead	
Lead-Lag Optimize?									
Recall Mode	None	None	None	None	None	C-Min	C-Min	None	C-Min
Act Effect Green (s)		21.0	39.1	35.8	35.8	31.1	31.1	44.9	41.2
Actuated g/C Ratio		0.23	0.43	0.40	0.40	0.35	0.35	0.50	0.46
v/c Ratio		0.94	0.89	0.77	0.64	0.79	0.99	0.66	0.37
Control Delay		40.5	48.7	32.1	8.8	40.1	47.2	23.7	17.0
Queue Delay		44.9	0.0	0.0	0.0	0.0	7.3	0.0	0.0
Total Delay		85.4	48.7	32.1	8.8	40.1	54.5	23.7	17.0
LOS		F	D	C	A	D	D	C	B
Approach Delay		85.4		26.8		48.9			20.5
Approach LOS		F		C		D			C
Queue Length 50th (m)		52.7	31.3	82.0	13.5	54.6	45.0	23.8	23.8
Queue Length 95th (m)		#97.6	m#72.4	m#129.3	m41.7	#96.6	#119.9	39.2	40.9
Internal Link Dist (m)		72.5		71.6		338.9			95.8
Turn Bay Length (m)								60.0	
Base Capacity (vph)		782	300	695	757	480	593	376	654
Starvation Cap Reductn		0	0	0	0	0	0	0	0
Spillback Cap Reductn		144	0	0	0	0	20	0	0
Storage Cap Reductn		0	0	0	0	0	0	0	0
Reduced v/c Ratio		1.15	0.89	0.77	0.64	0.76	1.01	0.66	0.36

Intersection Summary





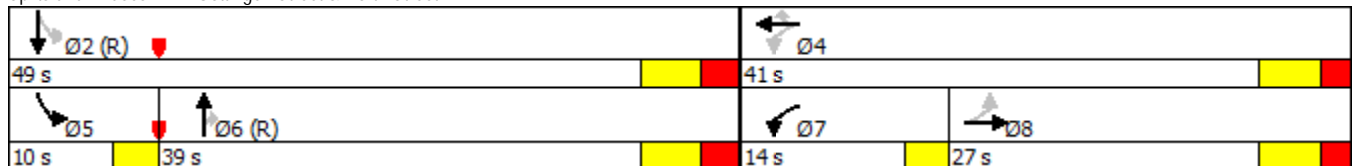









Cycle Length: 90
 Actuated Cycle Length: 90
 Offset: 17 (19%), Referenced to phase 2:SBTL and 6:NBT, Start of Green
 Natural Cycle: 90
 Control Type: Actuated-Coordinated
 Maximum v/c Ratio: 0.99
 Intersection Signal Delay: 44.4
 Intersection Capacity Utilization 106.5%
 Analysis Period (min) 15
 # 95th percentile volume exceeds capacity, queue may be longer.
 Queue shown is maximum after two cycles.
 m Volume for 95th percentile queue is metered by upstream signal.

Splits and Phases: 1: Gottingen Street & North Street



Halifax Transit Priority Corridors

2: Gottingen Street & Cornwallis Street

									
Lane Group	EBL2	EBT	WBL	WBT	NBL	NBT	NBR	SBL	SBT
Lane Configurations									
Traffic Volume (vph)	55	70	10	200	20	425	55	35	365
Future Volume (vph)	55	70	10	200	20	425	55	35	365
Lane Group Flow (vph)	0	156	0	311	0	494	72	0	495
Turn Type	Perm	NA	Perm	NA	Perm	NA	Perm	Perm	NA
Protected Phases		4		4		2			2
Permitted Phases	4		4		2		2	2	
Minimum Split (s)	29.0	29.0	29.0	29.0	28.0	28.0	28.0	28.0	28.0
Total Split (s)	35.0	35.0	35.0	35.0	55.0	55.0	55.0	55.0	55.0
Total Split (%)	38.9%	38.9%	38.9%	38.9%	61.1%	61.1%	61.1%	61.1%	61.1%
Yellow Time (s)	3.9	3.9	3.9	3.9	3.9	3.9	3.9	3.9	3.9
All-Red Time (s)	2.0	2.0	2.0	2.0	1.6	1.6	1.6	1.6	1.6
Lost Time Adjust (s)		0.0		0.0		0.0			0.0
Total Lost Time (s)		5.9		5.9		5.5			5.5
Lead/Lag									
Lead-Lag Optimize?									
Act Effct Green (s)		29.1		29.1		49.5	49.5		49.5
Actuated g/C Ratio		0.32		0.32		0.55	0.55		0.55
v/c Ratio		0.36		0.55		0.52	0.08		0.54
Control Delay		25.1		29.4		15.3	6.0		15.4
Queue Delay		0.0		0.0		0.0	0.0		0.8
Total Delay		25.1		29.4		15.3	6.0		16.2
LOS		C		C		B	A		B
Approach Delay		25.1		29.4		14.1			16.2
Approach LOS		C		C		B			B
Queue Length 50th (m)		19.5		43.8		50.4	2.8		50.2
Queue Length 95th (m)		35.8		69.1		76.6	8.6		77.0
Internal Link Dist (m)		136.3		95.8		282.9			129.1
Turn Bay Length (m)							85.0		
Base Capacity (vph)		436		569		949	867		919
Starvation Cap Reductn		0		0		0	0		183
Spillback Cap Reductn		0		0		0	0		0
Storage Cap Reductn		0		0		0	0		0
Reduced v/c Ratio		0.36		0.55		0.52	0.08		0.67

Intersection Summary

Cycle Length: 90
 Actuated Cycle Length: 90
 Offset: 0 (0%), Referenced to phase 2:NBSB, Start of Green
 Natural Cycle: 60
 Control Type: Pretimed
 Maximum v/c Ratio: 0.55
 Intersection Signal Delay: 19.0
 Intersection Capacity Utilization 88.7%
 Analysis Period (min) 15

Intersection LOS: B
 ICU Level of Service E

Splits and Phases: 2: Gottingen Street & Cornwallis Street

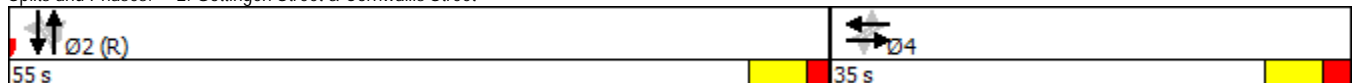

Halifax Transit Priority Corridors

3: Gottingen Street & Cogswell Street

Lane Group	EBL	EBT	EBR	WBL	WBT	WBR	NBL	NBT	SBL	SBT
Lane Configurations										
Traffic Volume (vph)	50	175	45	10	265	140	400	270	75	145
Future Volume (vph)	50	175	45	10	265	140	400	270	75	145
Lane Group Flow (vph)	0	258	52	11	305	161	460	327	86	236
Turn Type	Perm	NA	Perm	Perm	NA	Perm	pm+pt	NA	Perm	NA
Protected Phases		4			4		1	6		2
Permitted Phases	4		4	4		4	6		2	
Detector Phase	4	4		4	4		1	6	2	2
Switch Phase										
Minimum Initial (s)	7.0	7.0	7.0	7.0	7.0	7.0	7.0	7.0	7.0	7.0
Minimum Split (s)	36.7	36.7	36.7	36.7	36.7	36.7	11.0	44.2	44.2	44.2
Total Split (s)	38.0	38.0	38.0	38.0	38.0	38.0	16.0	62.0	46.0	46.0
Total Split (%)	38.0%	38.0%	38.0%	38.0%	38.0%	38.0%	16.0%	62.0%	46.0%	46.0%
Yellow Time (s)	4.1	4.1	4.1	4.1	4.1	4.1	4.0	4.1	4.1	4.1
All-Red Time (s)	2.6	2.6	2.6	2.6	2.6	2.6	0.0	3.1	3.1	3.1
Lost Time Adjust (s)		0.0	0.0	0.0	0.0	0.0	0.0	0.0	0.0	0.0
Total Lost Time (s)		6.7	6.7	6.7	6.7	6.7	4.0	7.2	7.2	7.2
Lead/Lag							Lead		Lag	Lag
Lead-Lag Optimize?										
Recall Mode	Max	Max	Max	Max	Max	Max	Max	C-Max	C-Max	C-Max
Act Effct Green (s)		31.3	31.3	31.3	31.3	31.3	58.0	54.8	38.8	38.8
Actuated g/C Ratio		0.31	0.31	0.31	0.31	0.31	0.58	0.55	0.39	0.39
v/c Ratio		0.35	0.12	0.04	0.59	0.33	0.79	0.43	0.25	0.39
Control Delay		28.2	2.2	24.6	34.5	6.2	25.9	15.3	23.2	22.0
Queue Delay		0.0	0.0	0.0	0.0	0.0	0.0	0.0	0.0	0.0
Total Delay		28.2	2.2	24.6	34.5	6.2	25.9	15.3	23.2	22.0
LOS		C	A	C	C	A	C	B	C	C
Approach Delay		23.9			24.7			21.5		22.3
Approach LOS		C			C			C		C
Queue Length 50th (m)		20.2	0.0	1.5	49.5	0.0	49.5	34.9	11.1	28.9
Queue Length 95th (m)		29.9	2.4	5.3	73.3	12.6	#72.5	52.5	21.9	46.5
Internal Link Dist (m)		66.6			100.9			105.8		282.9
Turn Bay Length (m)			30.0			50.0	50.0		50.0	
Base Capacity (vph)		731	442	288	518	490	579	765	347	609
Starvation Cap Reductn		0	0	0	0	0	0	0	0	0
Spillback Cap Reductn		0	0	0	0	0	0	0	0	0
Storage Cap Reductn		0	0	0	0	0	0	0	0	0
Reduced v/c Ratio		0.35	0.12	0.04	0.59	0.33	0.79	0.43	0.25	0.39

Intersection Summary

Cycle Length: 100
 Actuated Cycle Length: 100
 Offset: 17 (17%), Referenced to phase 2:SBTL and 6:NBTL, Start of Green
 Natural Cycle: 95
 Control Type: Actuated-Coordinated
 Maximum v/c Ratio: 0.79
 Intersection Signal Delay: 22.8
 Intersection Capacity Utilization 117.0%
 Analysis Period (min) 15
 # 95th percentile volume exceeds capacity, queue may be longer.
 Queue shown is maximum after two cycles.

Splits and Phases: 3: Gottingen Street & Cogswell Street

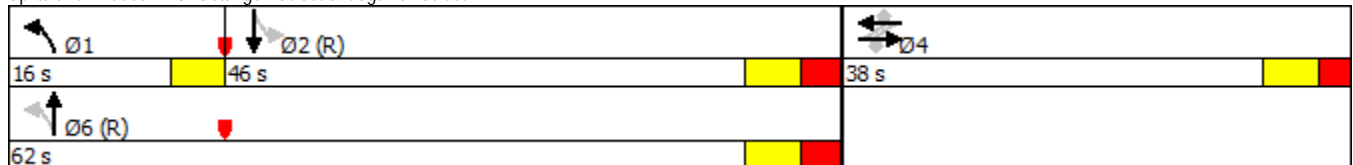

APPENDIX

G

BAYERS ROAD INTERSECTION CAPACITY ANALYSIS

Table G-1 - Bayers Road AM Peak Hour Intersection Analysis

Intersection		AM Peak Hour											
		Existing Conditions						Preferred Option					
		Scenario	Approach ¹	Delay	V/C	LOS	Queue	Option	Approach ¹	Delay	V/C	LOS	Queue
Bayers Road @	Romans	Existing (Page G-3)	EB-TR	41.4	1.01	D	277.6	High Invest ² (Page G-15)	EB-T	27.7	0.95	C	250.2
			EB-R	2.0	0.12	A	6.2		WB-T	4.9	0.42	A	25.1
			WB-TR	5.4	0.43	A	59.0		WB-R	0.2	0.02	A	0.0
			NB-L	40.9	0.29	D	24.1		NB-L	40.9	0.29	D	24.1
			NB-TR	36.4	0.21	D	23.9		NB-TR	38.1	0.21	D	24.5
				SB-LTR	29.2	0.33	C	28.0	SB-LTR	41.4	0.35	D	34.4
	HSC West	Existing (Page G-4)	EB-T	50.8	1.05	D	241.7	Medium Invest ³ (Page G-28)	EB-T	51.8	1.05	D	267.1
			EB-R	3.6	0.03	A	0.4		EB-R	3.4	0.03	A	0.4
			WB-T	2.8	0.46	A	9.3		WB-T	2.5	0.46	A	11.4
			NB-L	30.5	0.05	C	7.4		NB-L	30.5	0.05	C	7.4
	HSC East	Existing (Page G-5)	EB-TR	30.6	1.00	C	0.0	Medium Invest ³ (Page G-29)	EB-TR	27.7	1.00	C	0.0
			WB-L	28.5	0.29	C	31.3		WB-T	10.3	0.44	B	52.7
			WB-T	11.2	0.44	B	66.4		NB-R	22.6	0.23	C	19.4
			NB-R	29.0	0.24	C	22.6		SB-T	33.5	0.30	C	33.0
	Connaught	Existing (Page G-6)	EB-L	26.4	0.90	C	25.6	Medium Invest ⁴ (Page G-30)	EB-L	14.2	0.81	B	15.4
			EB-T	30.2	0.88	C	82.1		EB-T	29.9	0.88	C	86.4
			EB-R	56.6	0.99	E	196.8		EB-R	59.6	0.99	E	205.7
			WB-TR	28.0	0.60	C	78.8		WB-T	26.5	0.49	C	62.5
			NB-L	56.4	0.63	E	34.5		WB-R	3.6	0.21	A	4.5
			NB-TR	30.3	0.60	C	90.2		NB-L	52.3	0.52	D	28.7
			SB-T	36.4	0.28	D	28.3		NB-TR	32.6	0.66	C	102.2
			SB-R	24.1	0.28	C	32.2		SB-T	36.2	0.28	D	28.1
	Oxford	Existing (Page G-7)	EB-LT	2.7	0.50	A	14.2	High Invest ⁵ (Page G-17)	EB-LT	2.7	0.50	A	14.5
			EB-R	0.4	0.26	A	0.0		EB-R	0.4	0.26	A	0.0
			WB-LTR	3.3	0.18	A	12.6		WB-LT	6.2	0.30	A	40.8
			NB-L	64.0	0.68	E	36.9		WB-R	3.2	0.03	A	2.8
			NB-TR	47.9	0.59	D	41.7		NB-L	63.9	0.67	E	36.7
			SB-L	41.2	0.17	D	10.5		NB-TR	49.1	0.61	D	43.2
	Windsor	Existing (Page G-8)	SB-TR	50.8	0.54	D	36.0	High Invest ⁶ (Page G-18)	SB-L	42.0	0.19	D	11.2
			EB-L	10.8	0.12	B	7.6		SB-TR	51.4	0.53	D	36.2
			EB-T	28.1	0.83	C	158.1		EB-L	12.4	0.15	B	10.8
			EB-R	1.3	0.14	A	2.5		EB-T	27.1	0.79	C	147.3
			WB-L	16.9	0.28	B	15.0		EB-R	1.3	0.14	A	2.5
			WB-TR	13.4	0.21	B	22.7		WB-L	15.9	0.22	B	12.7
			NB-L	46.2	0.56	D	39.0		WB-T	19.3	0.34	B	52.3
			NB-T	34.8	0.42	C	54.5		WB-R	3.6	0.15	A	8.8
NB-R	6.5	0.32	A	14.8	NB-L	47.7	0.54	D	31.8				
			SB-L	23.7	0.32	C	31.5	NB-T	34.8	0.42	C	54.5	
			SB-TR	37.9	0.75	D	121.8	NB-R	6.4	0.32	A	15.0	
							SB-L	22.8	0.31	C	27.5		
							SB-TR	45.9	0.86	D	158.0		

- Notes:
1. Bayers Road is east/west for the full corridor
 2. Installation of eastbound and westbound right turn (except buses) lanes at Romans intersection.
 3. Realignment of HSC entering vehicles from westbound left to southbound through movement.
 4. Realignment of HSC entering traffic changes the traffic patterns at Connaught intersection; added westbound right turn lane (except buses).
 5. Reassignment of westbound through/right lane as right turn only (except buses) at Oxford intersection.
 6. Reassignment of westbound through/right lane as right turn only (except buses) and installation of eastbound right turn only lane (except buses) at Windsor intersection.

Table G-2 - Bayers Road PM Peak Hour Intersection Analysis

Intersection		PM Peak Hour											
		Existing Conditions						Preferred Option					
		Scenario	Approach ¹	Delay	V/C	LOS	Queue	Scenario	Approach ¹	Delay	V/C	LOS	Queue
Bayers Road @	Romans	Existing (Page G-9)	EB-TR	18.3	0.80	B	171.9	High Invest ² (Page G-21)	EB-T	15.7	0.72	B	143.1
			WB-TR	30.8	1.01	C	345.5		EB-R	1.9	0.14	A	7.1
			NB-L	161.9	1.10	F	73.9		WB-T	27.5	1.00	C	314.0
			NB-TR	40.0	0.25	D	33.1		WB-R	1.2	0.03	A	0.0
			SB-LTR	92.5	0.97	F	134.5		NB-L	161.9	1.10	F	73.9
	HSC West	Existing (Page G-10)	EB-T	20.8	0.59	C	130.6	Medium Invest ³ (Page G-34)	EB-T	16.7	0.55	B	124.8
			EB-R	8.8	0.10	A	11.8		EB-R	8.0	0.09	A	12.9
			WB-T	9.5	0.94	A	20.1		WB-T	7.0	0.89	A	20.3
			NB-L	48.3	0.58	D	64.4		NB-L	55.6	0.70	E	64.4
	HSC East	Existing (Page G-11)	EB-TR	2.6	0.56	A	0.0	Medium Invest ³ (Page G-35)	EB-TR	2.4	0.53	A	0.0
			WB-L	46.4	0.32	D	27.8		WB-T	8.5	0.84	A	30.5
			WB-T	34.8	0.89	C	38.1		NB-R	15.2	0.43	B	21.4
			NB-R	14.1	0.37	B	21.4		SB-T	50.6	0.39	D	37.8
	Connaught	Existing (Page G-12)	EB-L	124.4	1.07	F	96.0	Medium Invest ⁴ (Page G-36)	EB-L	109.2	1.03	F	89.9
			EB-T	39.5	0.80	D	122.8		EB-T	36.0	0.79	D	117.9
			EB-R	9.6	0.68	A	32.0		EB-R	9.8	0.68	A	31.4
			WB-TR	105.0	1.10	F	186.6		WB-T	93.7	0.99	F	158.0
			NB-L	88.0	1.03	F	153.8		WB-R	3.2	0.20	A	6.0
			NB-TR	17.9	0.24	B	38.9		NB-L	76.6	0.99	E	142.8
			SB-T	45.4	0.23	D	24.8		NB-TR	19.1	0.28	B	48.2
			SB-R	37.0	0.45	D	48.2		SB-T	45.6	0.23	D	25.1
	Oxford	Existing (Page G-13)	EB-LT	12.0	0.45	B	71.4	High Invest ⁵ (Page G-23)	EB-LT	12.0	0.45	B	71.1
			EB-R	2.7	0.11	A	6.0		EB-R	2.7	0.11	A	6.0
			WB-LTR	7.9	0.48	A	40.9		WB-LT	11.9	0.66	B	82.6
			NB-L	40.7	0.55	D	37.7		WB-R	1.5	0.20	A	4.8
			NB-TR	47.8	0.77	D	70.0		NB-L	41.2	0.56	D	37.9
			SB-L	30.4	0.16	C	8.6		NB-TR	47.8	0.77	D	70.0
			SB-TR	27.6	0.19	C	17.2		SB-L	30.4	0.16	C	8.6
	Windsor	Existing (Page G-14)	EB-L	30.0	0.44	C	20.8	High Invest ⁶ (Page G-24)	EB-L	27.1	0.37	C	20.5
			EB-TR	58.0	0.95	E	145.7		EB-T	42.3	0.83	D	122.0
			WB-L	32.8	0.66	C	32.3		EB-R	0.7	0.10	A	0.4
			WB-TR	19.1	0.45	B	50.9		WB-L	26.0	0.56	C	28.6
NB-L			18.0	0.29	B	24.9	WB-T		27.1	0.62	C	95.8	
NB-T			28.5	0.67	C	106.0	WB-R		3.8	0.23	A	11.0	
NB-R			3.9	0.21	A	10.6	NB-L		18.5	0.32	B	24.9	
SB-L			29.2	0.27	C	20.0	NB-T		28.5	0.67	C	106.0	
SB-TR			29.2	0.39	C	48.7	NB-R		3.9	0.21	A	10.6	
							SB-L	29.2	0.27	C	20.0		
							SB-TR	30.2	0.50	C	59.9		

- Notes:
1. Bayers Road is east/west for the full corridor
 2. Installation of eastbound and westbound right turn (except buses) lanes at Romans intersection.
 3. Realignment of HSC entering vehicles from westbound left to southbound through movement.
 4. Realignment of HSC entering traffic changes the traffic patterns at Connaught intersection; added westbound right turn lane (except buses).
 5. Reassignment of westbound through/right lane as right turn only (except buses) at Oxford intersection.
 6. Reassignment of westbound through/right lane as right turn only (except buses) and installation of eastbound right turn only lane (except buses) at Windsor intersection.

Lane Group	EBL	EBT	EBR	WBL	WBT	WBR	NBL	NBT	NBR	SBL	SBT	SBR
Lane Configurations												
Traffic Volume (vph)	5	1785	85	0	850	5	60	60	5	20	35	40
Future Volume (vph)	5	1785	85	0	850	5	60	60	5	20	35	40
Satd. Flow (prot)	0	2996	0	0	3096	0	1498	1544	0	0	1479	0
Flt Permitted		0.953					0.696				0.932	
Satd. Flow (perm)	0	2855	0	0	3096	0	1045	1544	0	0	1358	0
Satd. Flow (RTOR)		9			1			3			30	
Lane Group Flow (vph)	0	1973	0	0	900	0	63	68	0	0	100	0
Turn Type	Perm	NA			NA		Perm	NA		Perm	NA	
Protected Phases		2			2			4			4	
Permitted Phases	2						4			4		
Total Split (s)	80.0	80.0			80.0		30.0	30.0		30.0	30.0	
Total Lost Time (s)		5.8			5.8		6.1	6.1			6.1	
Act Effct Green (s)		75.1			75.1		23.0	23.0			23.0	
Actuated g/C Ratio		0.68			0.68		0.21	0.21			0.21	
v/c Ratio		1.01			0.43		0.29	0.21			0.33	
Control Delay		41.4			5.4		40.9	36.4			29.2	
Queue Delay		0.0			0.0		0.0	0.0			0.0	
Total Delay		41.4			5.4		40.9	36.4			29.2	
LOS		D			A		D	D			C	
Approach Delay		41.4			5.4			38.6			29.2	
Approach LOS		D			A			D			C	
Queue Length 50th (m)		-212.5			13.1		11.5	11.6			12.6	
Queue Length 95th (m)		#277.6			59.0		24.1	23.9			28.0	
Internal Link Dist (m)		76.6			386.3			826.4			535.1	
Turn Bay Length (m)							40.0					
Base Capacity (vph)		1952			2114		227	337			318	
Starvation Cap Reductn		0			0		0	0			0	
Spillback Cap Reductn		0			0		0	0			0	
Storage Cap Reductn		0			0		0	0			0	
Reduced v/c Ratio		1.01			0.43		0.28	0.20			0.31	

Intersection Summary

Cycle Length: 110
 Actuated Cycle Length: 110
 Offset: 8 (7%), Referenced to phase 2:EBWB and 6:, Start of Green
 Control Type: Actuated-Coordinated
 Maximum v/c Ratio: 1.01
 Intersection Signal Delay: 30.4
 Intersection Capacity Utilization 91.3%
 Analysis Period (min) 15
 ~ Volume exceeds capacity, queue is theoretically infinite.
 Queue shown is maximum after two cycles.
 # 95th percentile volume exceeds capacity, queue may be longer.
 Queue shown is maximum after two cycles.

Splits and Phases: 1: Romans & Bayers

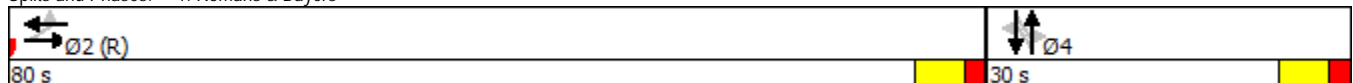

	→	↘	↙	←	↖	↗	Ø4
Lane Group	EBT	EBR	WBL	WBT	NBL	NBR	
Lane Configurations	↑↑	↑		↑↑	↘↙		
Traffic Volume (vph)	1800	25	0	795	35	0	
Future Volume (vph)	1800	25	0	795	35	0	
Satd. Flow (prot)	3131	1401	0	3131	3038	0	
Fit Permitted					0.950		
Satd. Flow (perm)	3131	1401	0	3131	3038	0	
Satd. Flow (RTOR)		10					
Lane Group Flow (vph)	2000	28	0	883	39	0	
Turn Type	NA	Perm		NA	Prot		
Protected Phases	2			6	8		4
Permitted Phases		2					
Total Split (s)	75.0	75.0		75.0	35.0		35.0
Total Lost Time (s)	7.9	7.9		7.9	6.0		
Act Effct Green (s)	67.1	67.1		67.1	29.0		
Actuated g/C Ratio	0.61	0.61		0.61	0.26		
v/c Ratio	1.05	0.03		0.46	0.05		
Control Delay	39.0	3.6		2.7	30.5		
Queue Delay	11.8	0.0		0.1	0.0		
Total Delay	50.8	3.6		2.8	30.5		
LOS	D	A		A	C		
Approach Delay	50.1			2.8	30.5		
Approach LOS	D			A	C		
Queue Length 50th (m)	~243.0	0.3		5.1	3.2		
Queue Length 95th (m)	m#241.7	m0.4		9.3	7.4		
Internal Link Dist (m)	386.3			15.6	295.6		
Turn Bay Length (m)		25.0					
Base Capacity (vph)	1909	858		1909	800		
Starvation Cap Reductn	0	0		204	0		
Spillback Cap Reductn	52	0		0	0		
Storage Cap Reductn	0	0		0	0		
Reduced v/c Ratio	1.08	0.03		0.52	0.05		

Intersection Summary

Cycle Length: 110
 Actuated Cycle Length: 110
 Offset: 34 (31%), Referenced to phase 2:EBT and 6:WBT, Start of Green
 Control Type: Actuated-Coordinated
 Maximum v/c Ratio: 1.05
 Intersection Signal Delay: 35.7
 Intersection Capacity Utilization 73.0%
 Analysis Period (min) 15
 ~ Volume exceeds capacity, queue is theoretically infinite.
 Queue shown is maximum after two cycles.
 # 95th percentile volume exceeds capacity, queue may be longer.
 Queue shown is maximum after two cycles.
 m Volume for 95th percentile queue is metered by upstream signal.

Splits and Phases: 2: HSC W & Bayers

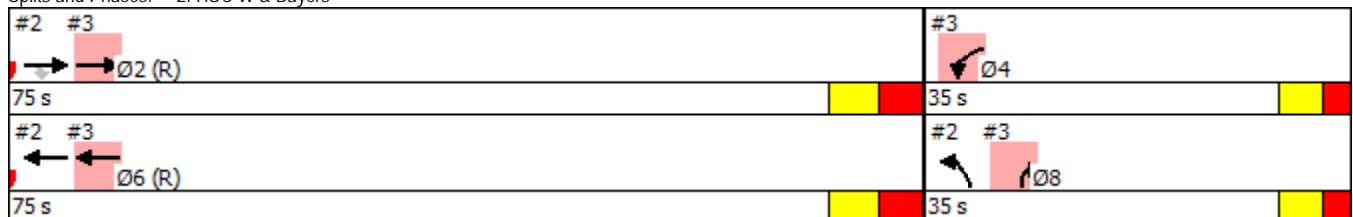

Lane Group	EBT	EBR	WBL	WBT	NBL	NBR
Lane Configurations						
Traffic Volume (vph)	1775	25	220	795	0	150
Future Volume (vph)	1775	25	220	795	0	150
Satd. Flow (prot)	3088	0	3008	3101	0	2442
Flt Permitted			0.950			
Satd. Flow (perm)	3088	0	3008	3101	0	2442
Satd. Flow (RTOR)	2					19
Lane Group Flow (vph)	1875	0	229	828	0	156
Turn Type	NA		Prot	NA		Prot
Protected Phases	2		4	6		8
Permitted Phases						
Total Split (s)	75.0		35.0	75.0		35.0
Total Lost Time (s)	7.9		6.0	7.9		6.0
Act Effct Green (s)	67.1		29.0	67.1		29.0
Actuated g/C Ratio	0.61		0.26	0.61		0.26
v/c Ratio	1.00		0.29	0.44		0.24
Control Delay	9.5		28.5	10.9		29.0
Queue Delay	21.0		0.0	0.3		0.0
Total Delay	30.6		28.5	11.2		29.0
LOS	C		C	B		C
Approach Delay	30.6			14.9	29.0	
Approach LOS	C			B	C	
Queue Length 50th (m)	0.0		19.8	47.0		13.0
Queue Length 95th (m)	m0.0		31.3	66.4		22.6
Internal Link Dist (m)	15.6			119.7	310.7	
Turn Bay Length (m)			45.0			
Base Capacity (vph)	1884		793	1891		657
Starvation Cap Reductn	85		0	441		0
Spillback Cap Reductn	114		0	0		0
Storage Cap Reductn	0		0	0		0
Reduced v/c Ratio	1.06		0.29	0.57		0.24

Intersection Summary

Cycle Length: 110
 Actuated Cycle Length: 110
 Offset: 34 (31%), Referenced to phase 2:EBT and 6:WBT, Start of Green
 Control Type: Actuated-Coordinated
 Maximum v/c Ratio: 1.05
 Intersection Signal Delay: 25.1
 Intersection Capacity Utilization 74.4%
 Analysis Period (min) 15
 m Volume for 95th percentile queue is metered by upstream signal.

Intersection LOS: C
ICU Level of Service D

Splits and Phases: 3: HSC E & Bayers

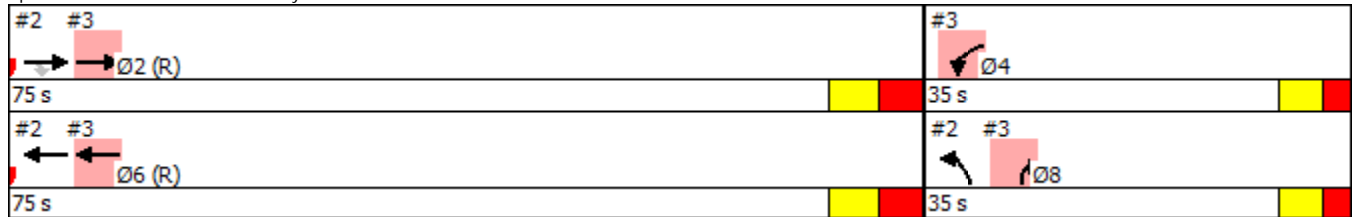

Halifax Transit Priority Corridors

4: Connaught & Bayers

Lane Group	EBL	EBT	EBR	WBL	WBT	WBR	NBL	NBT	NBR	SBL	SBT	SBR
Lane Configurations												
Traffic Volume (vph)	325	700	900	0	565	25	200	265	90	0	185	250
Future Volume (vph)	325	700	900	0	565	25	200	265	90	0	185	250
Satd. Flow (prot)	1551	1632	1387	0	2937	0	3008	1541	0	0	3039	2393
Fit Permitted	0.281						0.950					
Satd. Flow (perm)	455	1632	1326	0	2937	0	3008	1541	0	0	3039	2393
Satd. Flow (RTOR)			567		4			19				
Lane Group Flow (vph)	339	729	938	0	615	0	208	370	0	0	193	260
Turn Type	pm+pt	NA	Perm		NA		Prot	NA			NA	pt+ov
Protected Phases	5	2			6		3	8			4	4 5
Permitted Phases	2		2									
Total Split (s)	17.0	61.0	61.0		44.0		18.0	49.0			31.0	
Total Lost Time (s)	4.0	5.9	5.9		5.9		6.0	5.2			5.2	
Act Effct Green (s)	57.8	55.9	55.9		38.1		12.0	43.0			25.0	42.8
Actuated g/C Ratio	0.53	0.51	0.51		0.35		0.11	0.39			0.23	0.39
v/c Ratio	0.90	0.88	0.99		0.60		0.63	0.60			0.28	0.28
Control Delay	26.4	16.0	24.7		28.0		56.4	30.3			36.4	24.1
Queue Delay	0.0	14.2	31.9		0.0		0.0	0.0			0.0	0.0
Total Delay	26.4	30.2	56.6		28.0		56.4	30.3			36.4	24.1
LOS	C	C	E		C		E	C			D	C
Approach Delay		41.9			28.0			39.7			29.3	
Approach LOS		D			C			D			C	
Queue Length 50th (m)	22.3	76.4	198.7		48.7		22.3	59.1			18.1	21.4
Queue Length 95th (m)	m25.6	m82.1	m#196.8		78.8		34.5	90.2			28.3	32.2
Internal Link Dist (m)		119.7			440.1			461.8			84.0	
Turn Bay Length (m)	90.0						110.0					35.0
Base Capacity (vph)	376	829	952		1019		328	625			712	835
Starvation Cap Reductn	0	101	87		0		0	0			0	0
Spillback Cap Reductn	0	0	0		0		0	0			0	0
Storage Cap Reductn	0	0	0		0		0	0			0	0
Reduced v/c Ratio	0.90	1.00	1.08		0.60		0.63	0.59			0.27	0.31

Intersection Summary

Cycle Length: 110

Actuated Cycle Length: 110

Offset: 70 (64%), Referenced to phase 2:EBTL and 6:WBT, Start of Green

Control Type: Actuated-Coordinated

Maximum v/c Ratio: 0.99

Intersection Signal Delay: 37.6

Intersection LOS: D

Intersection Capacity Utilization 94.7%

ICU Level of Service F

Analysis Period (min) 15

95th percentile volume exceeds capacity, queue may be longer.

Queue shown is maximum after two cycles.

m Volume for 95th percentile queue is metered by upstream signal.

Splits and Phases: 4: Connaught & Bayers



Lane Group	EBL	EBT	EBR	WBL	WBT	WBR	NBL	NBT	NBR	SBL	SBT	SBR
Lane Configurations												
Traffic Volume (vph)	0	500	205	20	305	30	100	100	35	20	100	5
Future Volume (vph)	0	500	205	20	305	30	100	100	35	20	100	5
Satd. Flow (prot)	0	1419	1085	0	2942	0	1449	1485	0	1420	1334	0
Fit Permitted					0.913		0.682			0.588		
Satd. Flow (perm)	0	1419	1033	0	2692	0	1024	1485	0	802	1334	0
Satd. Flow (RTOR)			214		18			15			2	
Lane Group Flow (vph)	0	521	214	0	370	0	104	140	0	21	109	0
Turn Type		NA	Perm	Perm	NA		Perm	NA		Perm	NA	
Protected Phases		2			6			8			4	
Permitted Phases	2		2	6			8			4		
Total Split (s)	78.0	78.0	78.0	78.0	78.0		32.0	32.0		32.0	32.0	
Total Lost Time (s)		5.9	5.9		5.9		5.9	5.9		5.9	5.9	
Act Effct Green (s)		81.6	81.6		81.6		16.6	16.6		16.6	16.6	
Actuated g/C Ratio		0.74	0.74		0.74		0.15	0.15		0.15	0.15	
v/c Ratio		0.50	0.26		0.18		0.68	0.59		0.17	0.54	
Control Delay		2.7	0.4		3.3		64.0	47.9		41.2	50.8	
Queue Delay		0.0	0.0		0.0		0.0	0.0		0.0	0.0	
Total Delay		2.7	0.4		3.3		64.0	47.9		41.2	50.8	
LOS		A	A		A		E	D		D	D	
Approach Delay		2.0			3.3			54.8			49.3	
Approach LOS		A			A			D			D	
Queue Length 50th (m)		10.9	0.0		6.6		21.4	25.3		4.0	21.5	
Queue Length 95th (m)		m14.2	m0.0		12.6		36.9	41.7		10.5	36.0	
Internal Link Dist (m)		440.1			309.1			518.4			229.7	
Turn Bay Length (m)			60.0				65.0			60.0		
Base Capacity (vph)		1051	821		2000		242	363		190	318	
Starvation Cap Reductn		0	0		0		0	0		0	0	
Spillback Cap Reductn		0	0		0		0	0		0	0	
Storage Cap Reductn		0	0		0		0	0		0	0	
Reduced v/c Ratio		0.50	0.26		0.18		0.43	0.39		0.11	0.34	

Intersection Summary

Cycle Length: 110
 Actuated Cycle Length: 110
 Offset: 76 (69%), Referenced to phase 2:EBTL and 6:WBTL, Start of Green
 Control Type: Actuated-Coordinated
 Maximum v/c Ratio: 0.68
 Intersection Signal Delay: 15.2
 Intersection Capacity Utilization 57.8%
 Analysis Period (min) 15
 m Volume for 95th percentile queue is metered by upstream signal.

Intersection LOS: B
ICU Level of Service B

Splits and Phases: 5: Oxford & Bayers

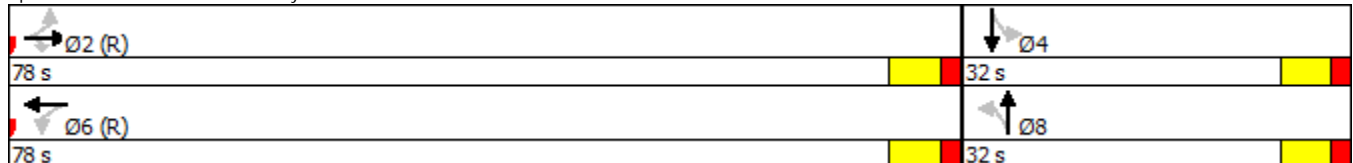

Halifax Transit Priority Corridors

6: Windsor & Bayers/Young

Lane Group	EBL	EBT	EBR	WBL	WBT	WBR	NBL	NBT	NBR	SBL	SBT	SBR
Lane Configurations												
Traffic Volume (vph)	40	395	80	65	205	70	100	180	150	125	420	0
Future Volume (vph)	40	395	80	65	205	70	100	180	150	125	420	0
Satd. Flow (prot)	1451	1523	0	1422	2899	0	1458	1607	1382	1473	1550	0
Fit Permitted	0.572			0.241			0.432			0.522		
Satd. Flow (perm)	873	1523	0	361	2899	0	663	1607	1350	803	1550	0
Satd. Flow (RTOR)		11		59					161			
Lane Group Flow (vph)	43	511	0	70	295	0	108	194	161	134	452	0
Turn Type	Perm	NA		pm+pt	NA		Perm	NA	Perm	pm+pt	NA	
Protected Phases		2		1	6			8		7	4	
Permitted Phases	2			6			8		8	4		
Total Split (s)	49.0	49.0		11.0	60.0		39.0	39.0	39.0	11.0	50.0	
Total Lost Time (s)	7.1	7.1		4.0	7.0		7.0	7.0	7.0	4.0	7.0	
Act Effct Green (s)	44.1	44.1		56.0	53.0		32.0	32.0	32.0	46.0	43.0	
Actuated g/C Ratio	0.40	0.40		0.51	0.48		0.29	0.29	0.29	0.42	0.39	
v/c Ratio	0.12	0.83		0.28	0.21		0.56	0.42	0.32	0.35	0.75	
Control Delay	10.8	28.1		16.9	13.4		46.2	34.8	6.5	23.7	37.9	
Queue Delay	0.0	0.0		0.0	0.0		0.0	0.0	0.0	0.0	0.0	
Total Delay	10.8	28.1		16.9	13.4		46.2	34.8	6.5	23.7	37.9	
LOS	B	C		B	B		D	C	A	C	D	
Approach Delay		26.8			14.1			27.6			34.7	
Approach LOS		C			B			C			C	
Queue Length 50th (m)	3.6	92.8		7.5	14.5		19.6	33.6	0.0	18.1	82.2	
Queue Length 95th (m)	m7.6	#158.1		15.0	22.7		39.0	54.5	14.8	31.5	121.8	
Internal Link Dist (m)		309.1			142.1			569.0			312.0	
Turn Bay Length (m)	50.0			40.0			90.0		50.0	40.0		
Base Capacity (vph)	349	616		251	1427		192	467	506	378	605	
Starvation Cap Reductn	0	0		0	0		0	0	0	0	0	
Spillback Cap Reductn	0	0		0	0		0	0	0	0	0	
Storage Cap Reductn	0	0		0	0		0	0	0	0	0	
Reduced v/c Ratio	0.12	0.83		0.28	0.21		0.56	0.42	0.32	0.35	0.75	

Intersection Summary

Cycle Length: 110
 Actuated Cycle Length: 110
 Offset: 14 (13%), Referenced to phase 2:EBTL and 6:WBTL, Start of Green
 Control Type: Actuated-Coordinated
 Maximum v/c Ratio: 0.83
 Intersection Signal Delay: 27.0
 Intersection Capacity Utilization 88.5%
 Analysis Period (min) 15
 # 95th percentile volume exceeds capacity, queue may be longer.
 Queue shown is maximum after two cycles.
 m Volume for 95th percentile queue is metered by upstream signal.

Splits and Phases: 6: Windsor & Bayers/Young

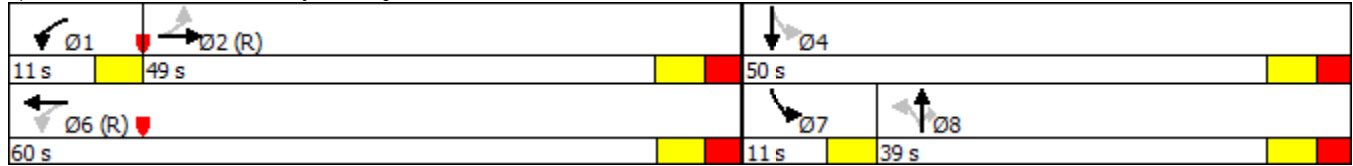

Halifax Transit Priority Corridors

1: Romans & Bayers

Lane Group	EBL	EBT	EBR	WBL	WBT	WBR	NBL	NBT	NBR	SBL	SBT	SBR
Lane Configurations												
Traffic Volume (vph)	0	1495	115	0	2125	5	120	75	15	5	30	270
Future Volume (vph)	0	1495	115	0	2125	5	120	75	15	5	30	270
Satd. Flow (prot)	0	3002	0	0	3130	0	1513	1531	0	0	1340	0
Fit Permitted							0.311				0.996	
Satd. Flow (perm)	0	3002	0	0	3130	0	480	1531	0	0	1334	0
Satd. Flow (RTOR)		14					7				12	
Lane Group Flow (vph)	0	1626	0	0	2151	0	121	91	0	0	308	0
Turn Type		NA			NA		Perm	NA		Perm	NA	
Protected Phases		2			2			4			4	
Permitted Phases							4			4		
Total Split (s)		94.0			94.0		36.0	36.0		36.0	36.0	
Total Lost Time (s)		5.8			5.8		6.1	6.1		6.1	6.1	
Act Effct Green (s)		88.2			88.2		29.9	29.9		29.9	29.9	
Actuated g/C Ratio		0.68			0.68		0.23	0.23		0.23	0.23	
v/c Ratio		0.80			1.01		1.10	0.25		0.97	0.97	
Control Delay		18.3			30.8		161.9	40.0		92.5	92.5	
Queue Delay		0.0			0.0		0.0	0.0		0.0	0.0	
Total Delay		18.3			30.8		161.9	40.0		92.5	92.5	
LOS		B			C		F	D		F	F	
Approach Delay		18.3			30.8			109.6			92.5	
Approach LOS		B			C			F			F	
Queue Length 50th (m)		139.6			-307.9		-35.0	17.7			76.3	
Queue Length 95th (m)		171.9			m#345.5		#73.9	33.1			#134.5	
Internal Link Dist (m)		1417.0			385.8			886.2			555.5	
Turn Bay Length (m)							40.0					
Base Capacity (vph)		2041			2123		110	357			316	
Starvation Cap Reductn		0			0		0	0			0	
Spillback Cap Reductn		0			0		0	0			0	
Storage Cap Reductn		0			0		0	0			0	
Reduced v/c Ratio		0.80			1.01		1.10	0.25			0.97	

Intersection Summary

Cycle Length: 130
 Actuated Cycle Length: 130
 Offset: 57 (44%), Referenced to phase 2:EBWB and 6:, Start of Green
 Control Type: Actuated-Coordinated
 Maximum v/c Ratio: 1.10
 Intersection Signal Delay: 34.4
 Intersection Capacity Utilization 123.9%
 Analysis Period (min) 15
 ~ Volume exceeds capacity, queue is theoretically infinite.
 Queue shown is maximum after two cycles.
 # 95th percentile volume exceeds capacity, queue may be longer.
 Queue shown is maximum after two cycles.
 m Volume for 95th percentile queue is metered by upstream signal.

Splits and Phases: 1: Romans & Bayers



							Ø1
Lane Group	EBT	EBR	WBL	WBT	NBL	NBR	
Lane Configurations							
Traffic Volume (vph)	1095	85	0	1760	365	0	
Future Volume (vph)	1095	85	0	1760	365	0	
Satd. Flow (prot)	3131	1401	0	3131	3038	0	
Fit Permitted					0.950		
Satd. Flow (perm)	3131	1401	0	3131	3038	0	
Satd. Flow (RTOR)		52					
Lane Group Flow (vph)	1217	94	0	1956	406	0	
Turn Type	NA	Perm		NA	Prot		
Protected Phases	2			6	8		1
Permitted Phases		2					
Total Split (s)	94.0	94.0		94.0	36.0		36.0
Total Lost Time (s)	7.9	7.9		7.9	6.0		
Act Effct Green (s)	86.1	86.1		86.1	30.0		
Actuated g/C Ratio	0.66	0.66		0.66	0.23		
v/c Ratio	0.59	0.10		0.94	0.58		
Control Delay	20.8	8.8		9.5	48.3		
Queue Delay	0.0	0.0		0.3	0.0		
Total Delay	20.8	8.8		9.9	48.3		
LOS	C	A		A	D		
Approach Delay	19.9			9.9	48.3		
Approach LOS	B			A	D		
Queue Length 50th (m)	106.3	7.1		14.3	47.9		
Queue Length 95th (m)	130.6	m11.8		#20.1	64.4		
Internal Link Dist (m)	385.8			14.6	462.4		
Turn Bay Length (m)		25.0					
Base Capacity (vph)	2073	945		2073	701		
Starvation Cap Reductn	0	0		12	0		
Spillback Cap Reductn	0	0		0	0		
Storage Cap Reductn	0	0		0	0		
Reduced v/c Ratio	0.59	0.10		0.95	0.58		

Intersection Summary

Cycle Length: 130
 Actuated Cycle Length: 130
 Offset: 28 (22%), Referenced to phase 2:EBT and 6:WBT, Start of Green
 Control Type: Actuated-Coordinated
 Maximum v/c Ratio: 0.94
 Intersection Signal Delay: 17.7
 Intersection Capacity Utilization 77.6%
 Analysis Period (min) 15
 # 95th percentile volume exceeds capacity, queue may be longer.
 Queue shown is maximum after two cycles.
 m Volume for 95th percentile queue is metered by upstream signal.

Intersection LOS: B
 ICU Level of Service D

Splits and Phases: 2: HSC W & Bayers

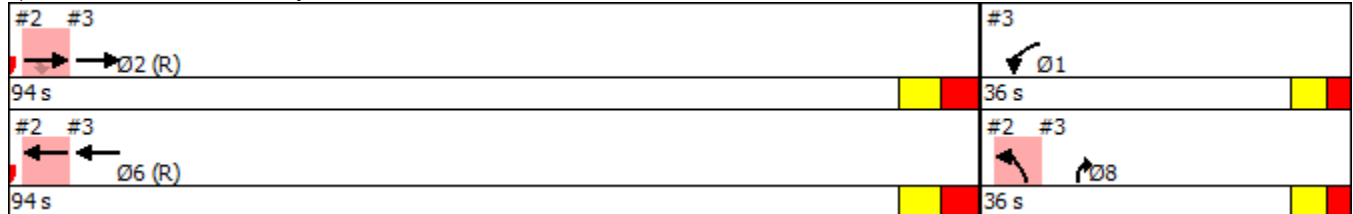

	→	↘	↙	←	↖	↗
Lane Group	EBT	EBR	WBL	WBT	NBL	NBR
Lane Configurations	↑↑		↘↙	↑↑		↗↖
Traffic Volume (vph)	1030	65	210	1760	0	255
Future Volume (vph)	1030	65	210	1760	0	255
Satd. Flow (prot)	3057	0	3008	3101	0	2442
Fit Permitted			0.950			
Satd. Flow (perm)	3057	0	3008	3101	0	2442
Satd. Flow (RTOR)	10					192
Lane Group Flow (vph)	1141	0	219	1833	0	266
Turn Type	NA		Prot	NA		Prot
Protected Phases	2		1	6		8
Permitted Phases						
Total Split (s)	94.0		36.0	94.0		36.0
Total Lost Time (s)	7.9		6.0	7.9		6.0
Act Effct Green (s)	86.1		30.0	86.1		30.0
Actuated g/C Ratio	0.66		0.23	0.66		0.23
v/c Ratio	0.56		0.32	0.89		0.37
Control Delay	2.6		46.4	8.3		14.0
Queue Delay	0.1		0.0	26.5		0.1
Total Delay	2.6		46.4	34.8		14.1
LOS	A		D	C		B
Approach Delay	2.6			36.0	14.1	
Approach LOS	A			D	B	
Queue Length 50th (m)	0.0		27.9	39.7		8.6
Queue Length 95th (m)	0.0		m27.8	m38.1		21.4
Internal Link Dist (m)	14.6			119.7	460.0	
Turn Bay Length (m)			45.0			
Base Capacity (vph)	2028		694	2053		711
Starvation Cap Reductn	87		0	311		0
Spillback Cap Reductn	23		0	9		72
Storage Cap Reductn	0		0	0		0
Reduced v/c Ratio	0.59		0.32	1.05		0.42

Intersection Summary

Cycle Length: 130
 Actuated Cycle Length: 130
 Offset: 28 (22%), Referenced to phase 2:EBT and 6:WBT, Start of Green
 Control Type: Actuated-Coordinated
 Maximum v/c Ratio: 0.94
 Intersection Signal Delay: 23.3
 Intersection Capacity Utilization 61.0%
 Analysis Period (min) 15
 m Volume for 95th percentile queue is metered by upstream signal.

Intersection LOS: C
ICU Level of Service B

Splits and Phases: 3: HSC E & Bayers

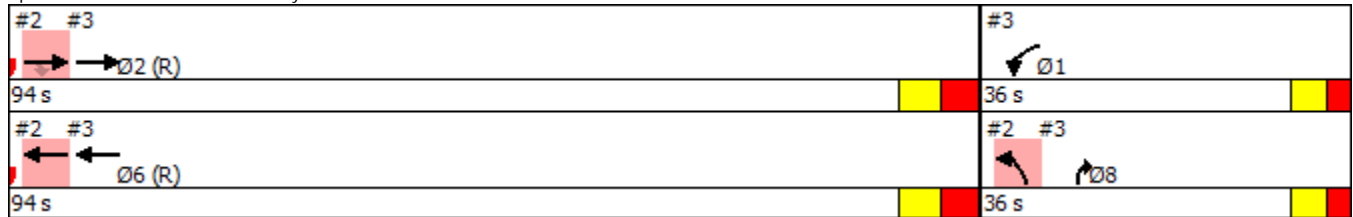

Lane Group	EBL	EBT	EBR	WBL	WBT	WBR	NBL	NBT	NBR	SBL	SBT	SBR
Lane Configurations												
Traffic Volume (vph)	195	515	575	0	900	10	780	145	35	0	130	290
Future Volume (vph)	195	515	575	0	900	10	780	145	35	0	130	290
Satd. Flow (prot)	1551	1632	1387	0	2939	0	3008	1562	0	0	3039	2393
Fit Permitted	0.095						0.950					
Satd. Flow (perm)	154	1632	1318	0	2939	0	2927	1562	0	0	3039	2269
Satd. Flow (RTOR)			575		1			13				
Lane Group Flow (vph)	203	536	599	0	948	0	813	187	0	0	135	302
Turn Type	pm+pt	NA	Perm		NA		Prot	NA			NA	pm+ov
Protected Phases	5	2			6		3	8			4	5
Permitted Phases	2		2									4
Total Split (s)	15.0	59.0	59.0		44.0		40.0	71.0			31.0	15.0
Total Lost Time (s)	4.0	5.9	5.9		5.9		6.0	5.2			5.2	4.0
Act Effct Green (s)	55.6	53.7	53.7		38.1		34.0	65.2			25.2	38.0
Actuated g/C Ratio	0.43	0.41	0.41		0.29		0.26	0.50			0.19	0.29
v/c Ratio	1.07	0.80	0.68		1.10		1.03	0.24			0.23	0.45
Control Delay	124.4	36.7	9.4		104.5		88.0	17.9			45.4	37.0
Queue Delay	0.0	2.7	0.2		0.5		0.0	0.0			0.0	0.0
Total Delay	124.4	39.5	9.6		105.0		88.0	17.9			45.4	37.0
LOS	F	D	A		F		F	B			D	D
Approach Delay		39.0			105.0			74.9			39.6	
Approach LOS		D			F			E			D	
Queue Length 50th (m)	-47.7	83.2	20.9		-145.1		-115.1	24.5			15.5	34.0
Queue Length 95th (m)	#96.0	122.8	32.0		#186.6		#153.8	38.9			24.8	48.2
Internal Link Dist (m)		119.7			440.1			1920.3			104.0	
Turn Bay Length (m)	90.0						110.0					35.0
Base Capacity (vph)	190	674	882		862		786	797			603	685
Starvation Cap Reductn	0	63	31		0		0	0			0	0
Spillback Cap Reductn	0	0	0		67		0	0			0	0
Storage Cap Reductn	0	0	0		0		0	0			0	0
Reduced v/c Ratio	1.07	0.88	0.70		1.19		1.03	0.23			0.22	0.44

Intersection Summary

Cycle Length: 130
 Actuated Cycle Length: 130
 Offset: 26 (20%), Referenced to phase 2:EBTL and 6:WBT, Start of Green
 Control Type: Actuated-Coordinated
 Maximum v/c Ratio: 1.10
 Intersection Signal Delay: 65.5
 Intersection Capacity Utilization 103.9%
 Analysis Period (min) 15
 Intersection LOS: E
 ICU Level of Service G

~ Volume exceeds capacity, queue is theoretically infinite.
 Queue shown is maximum after two cycles.
 # 95th percentile volume exceeds capacity, queue may be longer.
 Queue shown is maximum after two cycles.

Splits and Phases: 4: Connaught & Bayers

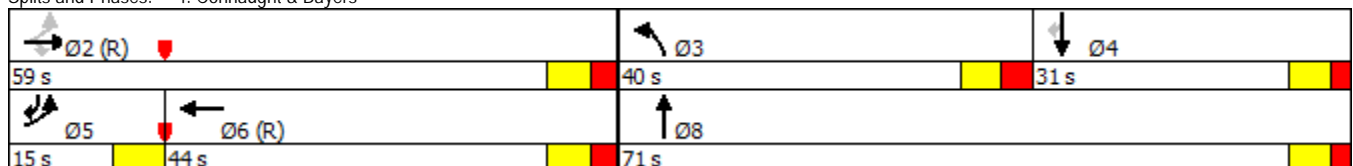

Halifax Transit Priority Corridors

5: Oxford & Bayers

Lane Group	EBL	EBT	EBR	WBL	WBT	WBR	NBL	NBT	NBR	SBL	SBT	SBR
Lane Configurations												
Traffic Volume (vph)	10	395	75	20	640	185	135	240	40	20	55	5
Future Volume (vph)	10	395	75	20	640	185	135	240	40	20	55	5
Satd. Flow (prot)	0	1429	1094	0	2874	0	1449	1548	0	1420	1325	0
Fit Permitted		0.977			0.940		0.717			0.376		
Satd. Flow (perm)	0	1398	1005	0	2703	0	1069	1548	0	544	1325	0
Satd. Flow (RTOR)			76		57			9			5	
Lane Group Flow (vph)	0	409	76	0	853	0	136	282	0	20	61	0
Turn Type	Perm	NA	Perm	Perm	NA		Perm	NA		Perm	NA	
Protected Phases		2			6			8			4	
Permitted Phases	2		2	6			8			4		
Total Split (s)	61.0	61.0	61.0	61.0	61.0		39.0	39.0		39.0	39.0	
Total Lost Time (s)		5.9	5.9		5.9		5.9	5.9		5.9	5.9	
Act Effct Green (s)		64.9	64.9		64.9		23.3	23.3		23.3	23.3	
Actuated g/C Ratio		0.65	0.65		0.65		0.23	0.23		0.23	0.23	
v/c Ratio		0.45	0.11		0.48		0.55	0.77		0.16	0.19	
Control Delay		12.0	2.7		7.9		40.7	47.8		30.4	27.6	
Queue Delay		0.0	0.0		0.0		0.0	0.0		0.0	0.0	
Total Delay		12.0	2.7		7.9		40.7	47.8		30.4	27.6	
LOS		B	A		A		D	D		C	C	
Approach Delay		10.6			7.9			45.5			28.3	
Approach LOS		B			A			D			C	
Queue Length 50th (m)		35.4	0.0		28.0		23.3	49.8		3.1	8.8	
Queue Length 95th (m)		71.4	6.0		40.9		37.7	70.0		8.6	17.2	
Internal Link Dist (m)		440.1			309.1			439.9			191.0	
Turn Bay Length (m)			60.0				65.0			60.0		
Base Capacity (vph)		906	678		1773		353	518		180	441	
Starvation Cap Reductn		0	0		0		0	0		0	0	
Spillback Cap Reductn		0	0		0		0	0		0	0	
Storage Cap Reductn		0	0		0		0	0		0	0	
Reduced v/c Ratio		0.45	0.11		0.48		0.39	0.54		0.11	0.14	

Intersection Summary

Cycle Length: 100
 Actuated Cycle Length: 100
 Offset: 65 (65%), Referenced to phase 2:EBTL and 6:WBTL, Start of Green
 Control Type: Actuated-Coordinated
 Maximum v/c Ratio: 0.77
 Intersection Signal Delay: 18.0
 Intersection Capacity Utilization 71.5%
 Analysis Period (min) 15

Intersection LOS: B
 ICU Level of Service C

Splits and Phases: 5: Oxford & Bayers

	Ø2 (R)			Ø4
61 s			39 s	
	Ø6 (R)			Ø8
61 s			39 s	

Lane Group	EBL	EBT	EBR	WBL	WBT	WBR	NBL	NBT	NBR	SBL	SBT	SBR
Lane Configurations												
Traffic Volume (vph)	90	410	50	140	420	150	120	455	140	60	190	0
Future Volume (vph)	90	410	50	140	420	150	120	455	140	60	190	0
Satd. Flow (prot)	1479	1560	0	1449	2948	0	1486	1638	1408	1501	1580	0
Fit Permitted	0.430			0.200			0.541			0.462		
Satd. Flow (perm)	669	1560	0	303	2948	0	835	1638	1372	725	1580	0
Satd. Flow (RTOR)		6		64					144			
Lane Group Flow (vph)	93	475	0	144	588	0	124	469	144	62	196	0
Turn Type	Perm	NA		pm+pt	NA		pm+pt	NA	Perm	Perm	NA	
Protected Phases		2		1	6		3	8			4	
Permitted Phases	2			6			8		8	4		
Total Split (s)	39.0	39.0		11.0	50.0		11.0	50.0	50.0	39.0	39.0	
Total Lost Time (s)	7.1	7.1		4.0	7.0		4.0	7.0	7.0	7.0	7.0	
Act Effct Green (s)	31.9	31.9		46.0	43.0		46.0	43.0	43.0	32.0	32.0	
Actuated g/C Ratio	0.32	0.32		0.46	0.43		0.46	0.43	0.43	0.32	0.32	
v/c Ratio	0.44	0.95		0.66	0.45		0.29	0.67	0.21	0.27	0.39	
Control Delay	30.0	58.0		32.8	19.1		18.0	28.5	3.9	29.2	29.2	
Queue Delay	0.0	0.0		0.0	0.0		0.0	0.0	0.0	0.0	0.0	
Total Delay	30.0	58.0		32.8	19.1		18.0	28.5	3.9	29.2	29.2	
LOS	C	E		C	B		B	C	A	C	C	
Approach Delay		53.4			21.8			21.9			29.2	
Approach LOS		D			C			C			C	
Queue Length 50th (m)	9.5	90.2		16.2	36.5		13.7	70.8	0.0	8.9	29.3	
Queue Length 95th (m)	20.8	#145.7		#32.3	50.9		24.9	106.0	10.6	20.0	48.7	
Internal Link Dist (m)		309.1			142.1			493.5			927.7	
Turn Bay Length (m)	50.0			40.0			90.0		50.0	40.0		
Base Capacity (vph)	213	501		219	1304		429	704	672	232	505	
Starvation Cap Reductn	0	0		0	0		0	0	0	0	0	
Spillback Cap Reductn	0	0		0	0		0	0	0	0	0	
Storage Cap Reductn	0	0		0	0		0	0	0	0	0	
Reduced v/c Ratio	0.44	0.95		0.66	0.45		0.29	0.67	0.21	0.27	0.39	

Intersection Summary

Cycle Length: 100
 Actuated Cycle Length: 100
 Offset: 77 (77%), Referenced to phase 2:EBTL and 6:WBT, Start of Green
 Control Type: Actuated-Coordinated
 Maximum v/c Ratio: 0.95
 Intersection Signal Delay: 30.5
 Intersection Capacity Utilization 92.3%
 Analysis Period (min) 15
 # 95th percentile volume exceeds capacity, queue may be longer.
 Queue shown is maximum after two cycles.

Intersection LOS: C
 ICU Level of Service F

Splits and Phases: 6: Windsor & Bayers/Young

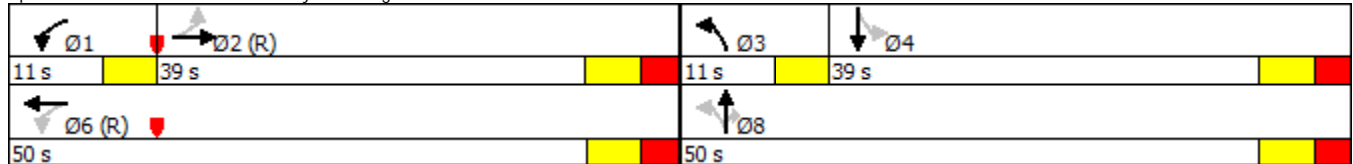

Lane Group	EBL	EBT	EBR	WBT	WBR	NBL2	NBT	SBL2	SBT
Lane Configurations									
Traffic Volume (vph)	5	1770	15	840	10	60	60	20	35
Future Volume (vph)	5	1770	15	840	10	60	60	20	35
Lane Group Flow (vph)	0	1868	106	884	16	63	68	0	100
Turn Type	Perm	NA	Perm	NA	Perm	Perm	NA	Perm	NA
Protected Phases		2		2			4		4
Permitted Phases	2		2		2	4		4	
Detector Phase	2	2	2	2	2	4	4	4	4
Switch Phase									
Minimum Initial (s)	10.0	10.0	10.0	10.0	10.0	10.0	10.0	10.0	10.0
Minimum Split (s)	23.8	23.8	23.8	23.8	23.8	29.1	29.1	29.1	29.1
Total Split (s)	80.0	80.0	80.0	80.0	80.0	30.0	30.0	30.0	30.0
Total Split (%)	72.7%	72.7%	72.7%	72.7%	72.7%	27.3%	27.3%	27.3%	27.3%
Yellow Time (s)	4.1	4.1	4.1	4.1	4.1	4.1	4.1	4.1	4.1
All-Red Time (s)	1.7	1.7	1.7	1.7	1.7	2.0	2.0	2.0	2.0
Lost Time Adjust (s)		0.0	0.0	0.0	0.0	0.0	0.0	0.0	0.0
Total Lost Time (s)		5.8	5.8	5.8	5.8	6.1	6.1		6.1
Lead/Lag									
Lead-Lag Optimize?									
Recall Mode	C-Min	C-Min	C-Min	C-Min	C-Min	Ped	Ped	Ped	Ped
Act Effct Green (s)		75.1	75.1	75.1	75.1	23.0	23.0		23.0
Actuated g/C Ratio		0.68	0.68	0.68	0.68	0.21	0.21		0.21
v/c Ratio		0.95	0.12	0.42	0.02	0.29	0.21		0.35
Control Delay		27.7	2.0	4.8	0.2	40.9	38.1		41.4
Queue Delay		0.0	0.0	0.0	0.0	0.0	0.0		0.0
Total Delay		27.7	2.0	4.8	0.2	40.9	38.1		41.4
LOS		C	A	A	A	D	D		D
Approach Delay		26.4		4.7			39.5		41.4
Approach LOS		C		A			D		D
Queue Length 50th (m)		169.8	1.1	31.0	0.2	11.5	12.2		18.5
Queue Length 95th (m)		#250.2	6.2	22.1	m0.0	24.1	24.5		34.4
Internal Link Dist (m)		76.6		386.3			826.4		535.1
Turn Bay Length (m)					80.0	40.0			
Base Capacity (vph)		1972	880	2117	841	227	335		295
Starvation Cap Reductn		0	0	0	0	0	0		0
Spillback Cap Reductn		0	0	0	0	0	0		0
Storage Cap Reductn		0	0	0	0	0	0		0
Reduced v/c Ratio		0.95	0.12	0.42	0.02	0.28	0.20		0.34

Intersection Summary

Cycle Length: 110
 Actuated Cycle Length: 110
 Offset: 8 (7%), Referenced to phase 2:EBWB and 6:, Start of Green
 Natural Cycle: 100
 Control Type: Actuated-Coordinated
 Maximum v/c Ratio: 0.95
 Intersection Signal Delay: 21.1
 Intersection Capacity Utilization 103.8%
 Analysis Period (min) 15
 # 95th percentile volume exceeds capacity, queue may be longer.
 Queue shown is maximum after two cycles.
 m Volume for 95th percentile queue is metered by upstream signal.

Splits and Phases: 1: Romans & Bayers

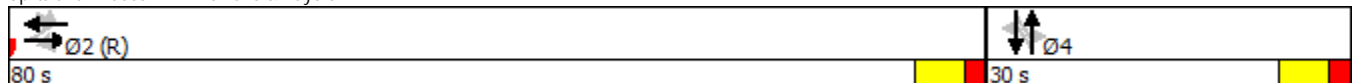

Halifax Transit Priority Corridors

4: Connaught & Bayers

Lane Group	EBL	EBT	EBR	WBT	WBR	NBL	NBT	SBT	SBR
Lane Configurations									
Traffic Volume (vph)	305	700	900	481	109	162	303	185	187
Future Volume (vph)	305	700	900	481	109	162	303	185	187
Lane Group Flow (vph)	318	729	938	501	114	169	410	193	195
Turn Type	pm+pt	NA	Perm	NA	Perm	Prot	NA	NA	pt+ov
Protected Phases	5	2		6		3	8	4	4.5
Permitted Phases	2		2		6				
Detector Phase	5	2	2	6	6	3	8	4	4.5
Switch Phase									
Minimum Initial (s)	7.0	10.0	10.0	10.0	10.0	7.0	10.0	10.0	
Minimum Split (s)	12.0	42.9	42.9	42.9	42.9	14.0	30.2	30.2	
Total Split (s)	17.0	61.0	61.0	44.0	44.0	18.0	49.0	31.0	
Total Split (%)	15.5%	55.5%	55.5%	40.0%	40.0%	16.4%	44.5%	28.2%	
Yellow Time (s)	5.0	4.1	4.1	4.1	4.1	4.0	4.1	4.1	
All-Red Time (s)	0.0	2.8	2.8	2.8	2.8	3.0	2.1	2.1	
Lost Time Adjust (s)	-1.0	-1.0	-1.0	-1.0	0.0	-1.0	-1.0	-1.0	
Total Lost Time (s)	4.0	5.9	5.9	5.9	6.9	6.0	5.2	5.2	
Lead/Lag	Lead			Lag	Lag	Lead		Lag	
Lead-Lag Optimize?									
Recall Mode	Max	C-Max	C-Max	C-Max	C-Max	Max	Ped	Ped	
Act Effct Green (s)	57.6	55.7	55.7	38.1	37.1	12.0	43.2	25.2	42.8
Actuated g/C Ratio	0.52	0.51	0.51	0.35	0.34	0.11	0.39	0.23	0.39
v/c Ratio	0.76	0.88	0.99	0.49	0.21	0.52	0.66	0.28	0.21
Control Delay	17.9	24.2	26.1	26.3	4.2	52.3	32.6	34.5	21.7
Queue Delay	0.0	0.0	0.0	0.0	0.0	0.0	0.0	0.0	0.0
Total Delay	17.9	24.2	26.1	26.3	4.2	52.3	32.6	34.5	21.7
LOS	B	C	C	C	A	D	C	C	C
Approach Delay		24.1		22.2			38.3	28.0	
Approach LOS		C		C			D	C	
Queue Length 50th (m)	15.8	85.8	0.0	38.2	1.1	17.9	68.8	18.1	15.5
Queue Length 95th (m)	m23.6	m125.1	m#170.6	62.6	5.1	28.7	102.2	28.5	25.3
Internal Link Dist (m)		119.1		146.3			461.8	84.0	
Turn Bay Length (m)	90.0				80.0	110.0			35.0
Base Capacity (vph)	420	827	951	1024	552	328	626	712	854
Starvation Cap Reductn	0	0	0	0	0	0	0	0	0
Spillback Cap Reductn	0	0	0	0	0	0	0	0	0
Storage Cap Reductn	0	0	0	0	0	0	0	0	0
Reduced v/c Ratio	0.76	0.88	0.99	0.49	0.21	0.52	0.65	0.27	0.23

Intersection Summary

Cycle Length: 110
 Actuated Cycle Length: 110
 Offset: 70 (64%), Referenced to phase 2:EBTL and 6:WBT, Start of Green
 Natural Cycle: 110
 Control Type: Actuated-Coordinated
 Maximum v/c Ratio: 0.99
 Intersection Signal Delay: 26.5
 Intersection Capacity Utilization 94.7%
 Analysis Period (min) 15
 # 95th percentile volume exceeds capacity, queue may be longer.
 Queue shown is maximum after two cycles.
 m Volume for 95th percentile queue is metered by upstream signal.

Splits and Phases: 4: Connaught & Bayers

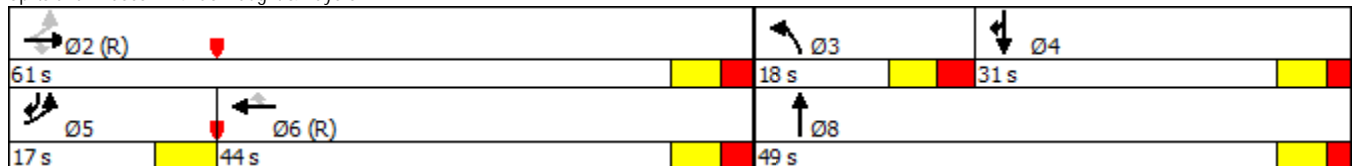

Halifax Transit Priority Corridors

5: Oxford & Bayers

Lane Group	EBT	EBR	WBL	WBT	WBR	NBL	NBT	SBL	SBT
Lane Configurations									
Traffic Volume (vph)	501	206	19	304	28	99	103	22	103
Future Volume (vph)	501	206	19	304	28	99	103	22	103
Lane Group Flow (vph)	522	215	0	337	29	103	145	23	108
Turn Type	NA	Perm	Perm	NA	Perm	Perm	NA	Perm	NA
Protected Phases	2			6			8		4
Permitted Phases		2	6		6	8		4	
Detector Phase	2	2	6	6	6	8	8	4	4
Switch Phase									
Minimum Initial (s)	10.0	10.0	10.0	10.0	10.0	10.0	10.0	10.0	10.0
Minimum Split (s)	24.9	24.9	24.9	24.9	24.9	23.9	23.9	23.9	23.9
Total Split (s)	78.0	78.0	78.0	78.0	78.0	32.0	32.0	32.0	32.0
Total Split (%)	70.9%	70.9%	70.9%	70.9%	70.9%	29.1%	29.1%	29.1%	29.1%
Yellow Time (s)	4.1	4.1	4.1	4.1	4.1	4.1	4.1	4.1	4.1
All-Red Time (s)	1.8	1.8	1.8	1.8	1.8	1.8	1.8	1.8	1.8
Lost Time Adjust (s)	0.0	0.0		0.0	0.0	0.0	0.0	0.0	0.0
Total Lost Time (s)	5.9	5.9		5.9	5.9	5.9	5.9	5.9	5.9
Lead/Lag									
Lead-Lag Optimize?									
Recall Mode	C-Max	C-Max	C-Max	C-Max	C-Max	None	None	None	None
Act Effct Green (s)	81.6	81.6		81.6	81.6	16.6	16.6	16.6	16.6
Actuated g/C Ratio	0.74	0.74		0.74	0.74	0.15	0.15	0.15	0.15
v/c Ratio	0.50	0.26		0.30	0.03	0.67	0.61	0.19	0.53
Control Delay	2.6	0.4		6.2	3.2	63.9	49.1	42.0	51.4
Queue Delay	0.0	0.0		0.0	0.0	0.0	0.0	0.0	0.0
Total Delay	2.6	0.4		6.2	3.2	63.9	49.1	42.0	51.4
LOS	A	A		A	A	E	D	D	D
Approach Delay	2.0			6.0			55.3		49.8
Approach LOS	A			A			E		D
Queue Length 50th (m)	11.1	0.0		12.9	0.0	21.2	26.5	4.4	21.7
Queue Length 95th (m)	m13.9	m0.0		m40.8	m2.8	36.7	43.2	11.2	36.2
Internal Link Dist (m)	269.4			309.1			518.4		229.7
Turn Bay Length (m)		60.0			60.0	65.0		60.0	
Base Capacity (vph)	1052	821		1124	974	241	363	185	318
Starvation Cap Reductn	0	0		0	0	0	0	0	0
Spillback Cap Reductn	0	0		0	0	0	0	0	0
Storage Cap Reductn	0	0		0	0	0	0	0	0
Reduced v/c Ratio	0.50	0.26		0.30	0.03	0.43	0.40	0.12	0.34

Intersection Summary

Cycle Length: 110
 Actuated Cycle Length: 110
 Offset: 76 (69%), Referenced to phase 2:EBTL and 6:WBTL, Start of Green
 Natural Cycle: 60
 Control Type: Actuated-Coordinated
 Maximum v/c Ratio: 0.67
 Intersection Signal Delay: 16.1
 Intersection Capacity Utilization 73.3%
 Analysis Period (min) 15
 m Volume for 95th percentile queue is metered by upstream signal.

Intersection LOS: B
ICU Level of Service D

Splits and Phases: 5: Oxford & Bayers

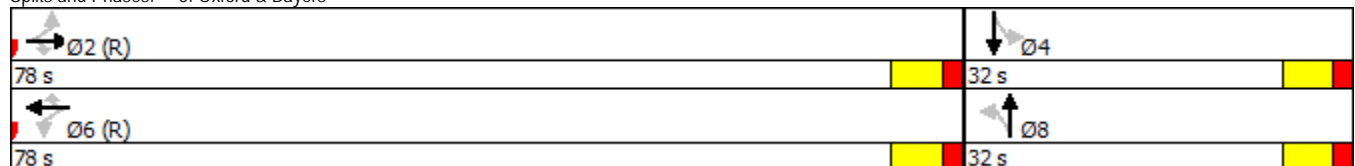

Lane Group	EBL	EBT	EBR	WBL	WBT	WBR	NBL	NBT	NBR	SBL	SBT
Lane Configurations											
Traffic Volume (vph)	52	457	79	53	243	99	76	180	151	108	436
Future Volume (vph)	52	457	79	53	243	99	76	180	151	108	436
Lane Group Flow (vph)	56	491	85	57	261	106	82	194	162	116	514
Turn Type	Perm	NA	Perm	pm+pt	NA	Perm	Perm	NA	Perm	pm+pt	NA
Protected Phases		2		1	6			8		7	4
Permitted Phases	2		2	6		6	8		8	4	
Detector Phase	2	2	2	1	6	6	8	8		7	4
Switch Phase											
Minimum Initial (s)	10.0	10.0	10.0	7.0	10.0	10.0	10.0	10.0	10.0	7.0	10.0
Minimum Split (s)	31.1	31.1	31.1	11.0	31.0	31.0	39.0	39.0	39.0	11.0	39.0
Total Split (s)	49.0	49.0	49.0	11.0	60.0	60.0	39.0	39.0	39.0	11.0	50.0
Total Split (%)	44.5%	44.5%	44.5%	10.0%	54.5%	54.5%	35.5%	35.5%	35.5%	10.0%	45.5%
Yellow Time (s)	4.1	4.1	4.1	4.0	4.0	4.0	4.1	4.1	4.1	4.0	4.1
All-Red Time (s)	3.0	3.0	3.0	0.0	3.0	3.0	2.9	2.9	2.9	0.0	2.9
Lost Time Adjust (s)	0.0	0.0	0.0	0.0	0.0	0.0	0.0	0.0	0.0	0.0	0.0
Total Lost Time (s)	7.1	7.1	7.1	4.0	7.0	7.0	7.0	7.0	7.0	4.0	7.0
Lead/Lag	Lag	Lag	Lag	Lead			Lag	Lag	Lag	Lead	
Lead-Lag Optimize?											
Recall Mode	C-Max	C-Max	C-Max	None	C-Max	C-Max	Ped	Ped	Ped	None	None
Act Effct Green (s)	44.1	44.1	44.1	56.0	53.0	53.0	32.0	32.0	32.0	46.0	43.0
Actuated g/C Ratio	0.40	0.40	0.40	0.51	0.48	0.48	0.29	0.29	0.29	0.42	0.39
v/c Ratio	0.15	0.79	0.14	0.22	0.34	0.15	0.54	0.42	0.32	0.31	0.86
Control Delay	12.3	26.9	1.2	15.9	19.3	3.6	47.7	34.8	6.4	22.8	45.9
Queue Delay	0.0	0.0	0.0	0.0	0.0	0.0	0.0	0.0	0.0	0.0	0.0
Total Delay	12.3	26.9	1.2	15.9	19.3	3.6	47.7	34.8	6.4	22.8	45.9
LOS	B	C	A	B	B	A	D	C	A	C	D
Approach Delay		22.2			14.9			26.7			41.7
Approach LOS		C			B			C			D
Queue Length 50th (m)	5.1	89.1	0.5	6.0	33.7	0.0	14.8	33.6	0.0	15.4	98.6
Queue Length 95th (m)	m10.8	#147.5	2.5	12.7	52.3	8.8	31.8	54.5	15.0	27.5	#158.0
Internal Link Dist (m)		309.1			142.1			569.0			312.0
Turn Bay Length (m)	50.0		60.0	40.0		60.0	90.0		50.0	40.0	
Base Capacity (vph)	365	625	603	263	764	704	153	467	507	378	601
Starvation Cap Reductn	0	0	0	0	0	0	0	0	0	0	0
Spillback Cap Reductn	0	0	0	0	0	0	0	0	0	0	0
Storage Cap Reductn	0	0	0	0	0	0	0	0	0	0	0
Reduced v/c Ratio	0.15	0.79	0.14	0.22	0.34	0.15	0.54	0.42	0.32	0.31	0.86

Intersection Summary





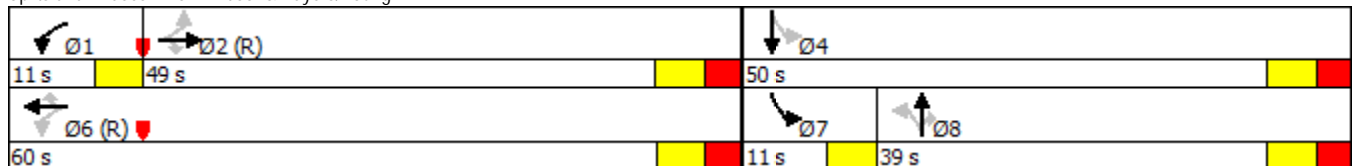





Cycle Length: 110
 Actuated Cycle Length: 110
 Offset: 14 (13%), Referenced to phase 2:EBTL and 6:WBTL, Start of Green
 Natural Cycle: 95
 Control Type: Actuated-Coordinated
 Maximum v/c Ratio: 0.86
 Intersection Signal Delay: 27.4
 Intersection Capacity Utilization 90.5%
 Analysis Period (min) 15
 # 95th percentile volume exceeds capacity, queue may be longer.
 Queue shown is maximum after two cycles.
 m Volume for 95th percentile queue is metered by upstream signal.

Splits and Phases: 6: Windsor & Bayers/Young



Halifax Transit Priority Corridors

7: Connaught & HSC

					
Lane Group	EBL	EBR	NBL	NBT	SBT
Lane Configurations					 
Traffic Volume (vph)	20	35	122	575	337
Future Volume (vph)	20	35	122	575	337
Lane Group Flow (vph)	22	39	136	639	483
Turn Type	Prot	Perm	Perm	NA	NA
Protected Phases	8			6	2
Permitted Phases		8	6		
Detector Phase	8	8	6	6	2
Switch Phase					
Minimum Initial (s)	8.0	8.0	8.0	8.0	8.0
Minimum Split (s)	24.0	24.0	24.0	24.0	24.0
Total Split (s)	26.0	26.0	84.0	84.0	84.0
Total Split (%)	23.6%	23.6%	76.4%	76.4%	76.4%
Yellow Time (s)	4.0	4.0	4.0	4.0	4.0
All-Red Time (s)	2.0	2.0	2.0	2.0	2.0
Lost Time Adjust (s)	0.0	0.0	0.0	0.0	0.0
Total Lost Time (s)	6.0	6.0	6.0	6.0	6.0
Lead/Lag					
Lead-Lag Optimize?					
Recall Mode	None	None	C-Min	C-Min	C-Min
Act Effct Green (s)	8.3	8.3	93.7	93.7	93.7
Actuated g/C Ratio	0.08	0.08	0.85	0.85	0.85
v/c Ratio	0.19	0.28	0.20	0.46	0.19
Control Delay	51.5	20.2	2.2	2.9	1.8
Queue Delay	0.0	0.0	0.0	0.6	0.0
Total Delay	51.5	20.2	2.2	3.5	1.8
LOS	D	C	A	A	A
Approach Delay	31.5			3.3	1.8
Approach LOS	C			A	A
Queue Length 50th (m)	4.5	0.0	4.0	22.7	7.2
Queue Length 95th (m)	12.3	10.2	m5.6	23.3	11.1
Internal Link Dist (m)	378.7			84.0	290.6
Turn Bay Length (m)	50.0				
Base Capacity (vph)	284	286	669	1404	2539
Starvation Cap Reductn	0	0	0	408	0
Spillback Cap Reductn	0	0	0	0	0
Storage Cap Reductn	0	0	0	0	0
Reduced v/c Ratio	0.08	0.14	0.20	0.64	0.19

Intersection Summary

Cycle Length: 110
 Actuated Cycle Length: 110
 Offset: 65 (59%), Referenced to phase 2:SBT and 6:NBTL, Start of Green
 Natural Cycle: 60
 Control Type: Actuated-Coordinated
 Maximum v/c Ratio: 0.46
 Intersection Signal Delay: 4.0
 Intersection Capacity Utilization 50.5%
 Analysis Period (min) 15
 m Volume for 95th percentile queue is metered by upstream signal.





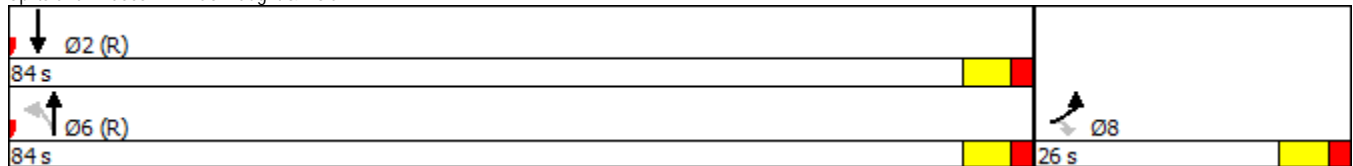





Intersection LOS: A
ICU Level of Service A

Splits and Phases: 7: Connaught & HSC



Halifax Transit Priority Corridors

2: HSC W & Bayers

						
Movement	EBT	EBR	WBL	WBT	NBL	NBR
Lane Configurations						
Traffic Volume (veh/h)	1775	50	0	830	0	130
Future Volume (Veh/h)	1775	50	0	830	0	130
Sign Control	Free			Free	Stop	
Grade	0%			0%	0%	
Peak Hour Factor	0.90	0.90	0.90	0.90	0.90	0.90
Hourly flow rate (vph)	1972	56	0	922	0	144
Pedestrians						
Lane Width (m)						
Walking Speed (m/s)						
Percent Blockage						
Right turn flare (veh)						
Median type	None			None		
Median storage (veh)						
Upstream signal (m)				183		
pX, platoon unblocked					0.89	
vC, conflicting volume			2028		2433	986
vC1, stage 1 conf vol						
vC2, stage 2 conf vol						
vCu, unblocked vol			2028		2363	986
IC, single (s)			4.1		6.8	6.9
IC, 2 stage (s)						
IF (s)			2.2		3.5	3.3
p0 queue free %			100		100	42
cM capacity (veh/h)			276		26	247
Direction, Lane #	EB 1	EB 2	EB 3	WB 1	WB 2	NB 1
Volume Total	986	986	56	461	461	144
Volume Left	0	0	0	0	0	0
Volume Right	0	0	56	0	0	144
cSH	1700	1700	1700	1700	1700	247
Volume to Capacity	0.58	0.58	0.03	0.27	0.27	0.58
Queue Length 95th (m)	0.0	0.0	0.0	0.0	0.0	25.4
Control Delay (s)	0.0	0.0	0.0	0.0	0.0	38.2
Lane LOS						E
Approach Delay (s)	0.0			0.0		38.2
Approach LOS						E
Intersection Summary						
Average Delay			1.8			
Intersection Capacity Utilization			70.5%	ICU Level of Service		C
Analysis Period (min)			15			

Halifax Transit Priority Corridors

1: Romans & Bayers

Lane Group	EBT	EBR	WBT	WBR	NBL2	NBT	SBL2	SBT
Lane Configurations								
Traffic Volume (vph)	1485	10	2110	15	120	75	5	30
Future Volume (vph)	1485	10	2110	15	120	75	5	30
Lane Group Flow (vph)	1500	127	2131	22	121	91	0	308
Turn Type	NA	Perm	NA	Perm	Perm	NA	Perm	NA
Protected Phases	2		2			4		4
Permitted Phases		2		2	4		4	
Detector Phase	2	2	2	2	4	4	4	4
Switch Phase								
Minimum Initial (s)	10.0	10.0	10.0	10.0	10.0	10.0	10.0	10.0
Minimum Split (s)	23.8	23.8	23.8	23.8	29.1	29.1	29.1	29.1
Total Split (s)	94.0	94.0	94.0	94.0	36.0	36.0	36.0	36.0
Total Split (%)	72.3%	72.3%	72.3%	72.3%	27.7%	27.7%	27.7%	27.7%
Yellow Time (s)	4.1	4.1	4.1	4.1	4.1	4.1	4.1	4.1
All-Red Time (s)	1.7	1.7	1.7	1.7	2.0	2.0	2.0	2.0
Lost Time Adjust (s)	0.0	0.0	0.0	0.0	0.0	0.0	0.0	0.0
Total Lost Time (s)	5.8	5.8	5.8	5.8	6.1	6.1		6.1
Lead/Lag								
Lead-Lag Optimize?								
Recall Mode	C-Min	C-Min	C-Min	C-Min	Ped	Ped	Ped	Ped
Act Effct Green (s)	88.2	88.2	88.2	88.2	29.9	29.9		29.9
Actuated g/C Ratio	0.68	0.68	0.68	0.68	0.23	0.23		0.23
v/c Ratio	0.72	0.14	1.00	0.03	1.10	0.26		1.01
Control Delay	15.7	1.9	29.0	1.1	161.9	43.4		102.9
Queue Delay	0.0	0.0	0.0	0.0	0.0	0.0		0.0
Total Delay	15.7	1.9	29.0	1.1	161.9	43.4		102.9
LOS	B	A	C	A	F	D		F
Approach Delay	14.7		28.7			111.0		102.9
Approach LOS	B		C			F		F
Queue Length 50th (m)	117.1	0.8	-205.6	0.0	-35.0	19.2		-80.0
Queue Length 95th (m)	143.1	7.1	m#315.6	m0.0	#73.9	34.8		#138.7
Internal Link Dist (m)	1417.0		385.8			886.2		555.5
Turn Bay Length (m)		80.0		80.0	40.0			
Base Capacity (vph)	2076	877	2124	775	110	352		306
Starvation Cap Reductn	0	0	0	0	0	0		0
Spillback Cap Reductn	0	0	0	0	0	0		0
Storage Cap Reductn	0	0	0	0	0	0		0
Reduced v/c Ratio	0.72	0.14	1.00	0.03	1.10	0.26		1.01

Intersection Summary

Cycle Length: 130
 Actuated Cycle Length: 130
 Offset: 57 (44%), Referenced to phase 2:EBWB and 6:, Start of Green
 Natural Cycle: 120
 Control Type: Actuated-Coordinated
 Maximum v/c Ratio: 1.10
 Intersection Signal Delay: 32.8
 Intersection Capacity Utilization 123.3%
 Analysis Period (min) 15
 ~ Volume exceeds capacity, queue is theoretically infinite.
 Queue shown is maximum after two cycles.
 # 95th percentile volume exceeds capacity, queue may be longer.
 Queue shown is maximum after two cycles.
 m Volume for 95th percentile queue is metered by upstream signal.

Splits and Phases: 1: Romans & Bayers



Halifax Transit Priority Corridors

4: Connaught & Bayers

Lane Group	EBL	EBT	EBR	WBT	WBR	NBL	NBT	SBT	SBR
Lane Configurations									
Traffic Volume (vph)	161	515	575	820	90	744	181	130	561
Future Volume (vph)	161	515	575	820	90	744	181	130	561
Lane Group Flow (vph)	168	536	599	854	94	775	225	135	584
Turn Type	pm+pt	NA	Perm	NA	Perm	Prot	NA	NA	pt+ov
Protected Phases	5	2		6		3	8	4	4.5
Permitted Phases	2		2		6				
Detector Phase	5	2	2	6	6	3	8	4	4.5
Switch Phase									
Minimum Initial (s)	7.0	10.0	10.0	10.0	10.0	7.0	10.0	10.0	
Minimum Split (s)	12.0	42.9	42.9	42.9	42.9	14.0	30.2	30.2	
Total Split (s)	15.0	59.0	59.0	44.0	44.0	40.0	71.0	31.0	
Total Split (%)	11.5%	45.4%	45.4%	33.8%	33.8%	30.8%	54.6%	23.8%	
Yellow Time (s)	5.0	4.1	4.1	4.1	4.1	4.0	4.1	4.1	
All-Red Time (s)	0.0	2.8	2.8	2.8	2.8	3.0	2.1	2.1	
Lost Time Adjust (s)	-1.0	-1.0	-1.0	-1.0	0.0	-1.0	-1.0	-1.0	
Total Lost Time (s)	4.0	5.9	5.9	5.9	6.9	6.0	5.2	5.2	
Lead/Lag	Lead			Lag	Lag	Lead		Lag	
Lead-Lag Optimize?									
Recall Mode	Max	C-Max	C-Max	C-Max	C-Max	Max	Ped	Ped	
Act Effect Green (s)	55.0	53.1	53.1	38.1	37.1	34.0	65.8	25.8	40.8
Actuated g/C Ratio	0.42	0.41	0.41	0.29	0.29	0.26	0.51	0.20	0.31
v/c Ratio	0.89	0.80	0.68	0.99	0.20	0.99	0.28	0.22	0.78
Control Delay	58.3	36.8	14.3	74.0	3.2	76.6	18.7	44.9	48.9
Queue Delay	0.0	0.0	0.0	0.0	0.0	0.0	0.0	0.0	0.5
Total Delay	58.3	36.8	14.3	74.0	3.2	76.6	18.7	44.9	49.3
LOS	E	D	B	E	A	E	B	D	D
Approach Delay		29.2		67.0			63.6	48.5	
Approach LOS		C		E			E	D	
Queue Length 50th (m)	30.2	128.3	68.7	114.7	0.0	102.2	30.5	15.4	77.1
Queue Length 95th (m)	m#58.2	178.5	127.1	#158.0	6.0	#142.8	47.5	24.8	101.5
Internal Link Dist (m)		119.7		132.1			1920.3	104.0	
Turn Bay Length (m)	90.0				80.0	110.0			35.0
Base Capacity (vph)	189	666	878	863	470	786	802	603	751
Starvation Cap Reductn	0	0	0	0	0	0	0	0	23
Spillback Cap Reductn	0	0	0	0	0	0	0	0	0
Storage Cap Reductn	0	0	0	0	0	0	0	0	0
Reduced v/c Ratio	0.89	0.80	0.68	0.99	0.20	0.99	0.28	0.22	0.80

Intersection Summary

Cycle Length: 130
 Actuated Cycle Length: 130
 Offset: 26 (20%), Referenced to phase 2:EBTL and 6:WBT, Start of Green
 Natural Cycle: 120
 Control Type: Actuated-Coordinated
 Maximum v/c Ratio: 0.99
 Intersection Signal Delay: 50.4
 Intersection Capacity Utilization 100.6%
 Analysis Period (min) 15
 # 95th percentile volume exceeds capacity, queue may be longer.
 Queue shown is maximum after two cycles.
 m Volume for 95th percentile queue is metered by upstream signal.

Splits and Phases: 4: Connaught & Bayers

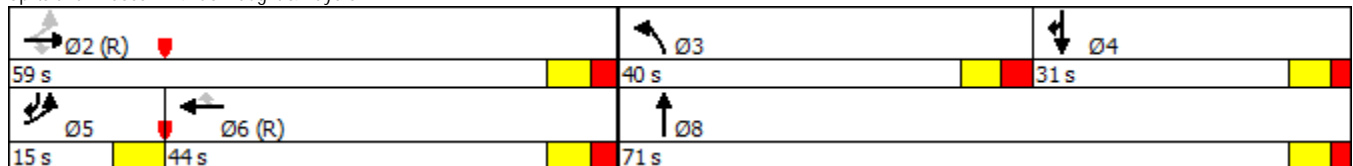

Halifax Transit Priority Corridors

5: Oxford & Bayers

Lane Group	EBL	EBT	EBR	WBL	WBT	WBR	NBL	NBT	SBL	SBT
Lane Configurations										
Traffic Volume (vph)	10	395	75	20	640	185	135	240	20	55
Future Volume (vph)	10	395	75	20	640	185	135	240	20	55
Lane Group Flow (vph)	0	409	76	0	666	187	136	282	20	61
Turn Type	Perm	NA	Perm	Perm	NA	Perm	Perm	NA	Perm	NA
Protected Phases		2			6			8		4
Permitted Phases	2		2	6		6	8		4	
Detector Phase	2	2	2	6	6	6	8	8	4	4
Switch Phase										
Minimum Initial (s)	10.0	10.0	10.0	10.0	10.0	10.0	10.0	10.0	10.0	10.0
Minimum Split (s)	24.9	24.9	24.9	24.9	24.9	24.9	23.9	23.9	23.9	23.9
Total Split (s)	61.0	61.0	61.0	61.0	61.0	61.0	39.0	39.0	39.0	39.0
Total Split (%)	61.0%	61.0%	61.0%	61.0%	61.0%	61.0%	39.0%	39.0%	39.0%	39.0%
Yellow Time (s)	4.1	4.1	4.1	4.1	4.1	4.1	4.1	4.1	4.1	4.1
All-Red Time (s)	1.8	1.8	1.8	1.8	1.8	1.8	1.8	1.8	1.8	1.8
Lost Time Adjust (s)		0.0	0.0		0.0	0.0	0.0	0.0	0.0	0.0
Total Lost Time (s)		5.9	5.9		5.9	5.9	5.9	5.9	5.9	5.9
Lead/Lag										
Lead-Lag Optimize?										
Recall Mode	C-Max	C-Max	C-Max	C-Max	C-Max	C-Max	None	None	None	None
Act Effct Green (s)		64.9	64.9		64.9	64.9	23.3	23.3	23.3	23.3
Actuated g/C Ratio		0.65	0.65		0.65	0.65	0.23	0.23	0.23	0.23
v/c Ratio		0.45	0.11		0.66	0.20	0.56	0.77	0.16	0.20
Control Delay		12.0	2.7		11.9	1.5	41.2	47.8	30.4	27.6
Queue Delay		0.0	0.0		0.0	0.0	0.0	0.0	0.0	0.0
Total Delay		12.0	2.7		11.9	1.5	41.2	47.8	30.4	27.6
LOS		B	A		B	A	D	D	C	C
Approach Delay		10.5			9.6			45.7		28.3
Approach LOS		B			A			D		C
Queue Length 50th (m)		35.4	0.0		49.9	0.0	23.4	49.8	3.1	8.8
Queue Length 95th (m)		71.1	6.0		82.6	4.8	37.9	70.0	8.6	17.2
Internal Link Dist (m)		283.7			309.1			439.9		191.0
Turn Bay Length (m)			60.0			60.0	65.0		60.0	
Base Capacity (vph)		913	678		1006	920	348	518	180	441
Starvation Cap Reductn		0	0		0	0	0	0	0	0
Spillback Cap Reductn		0	0		0	0	0	0	0	0
Storage Cap Reductn		0	0		0	0	0	0	0	0
Reduced v/c Ratio		0.45	0.11		0.66	0.20	0.39	0.54	0.11	0.14

Intersection Summary

Cycle Length: 100
 Actuated Cycle Length: 100
 Offset: 65 (65%), Referenced to phase 2:EBTL and 6:WBTL, Start of Green
 Natural Cycle: 60
 Control Type: Actuated-Coordinated
 Maximum v/c Ratio: 0.77
 Intersection Signal Delay: 18.9
 Intersection Capacity Utilization 84.1%
 Analysis Period (min) 15

Intersection LOS: B
 ICU Level of Service E

Splits and Phases: 5: Oxford & Bayers

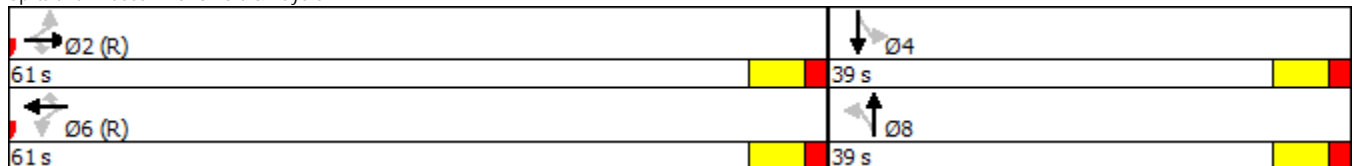

Lane Group	EBL	EBT	EBR	WBL	WBT	WBR	NBL	NBT	NBR	SBL	SBT
Lane Configurations											
Traffic Volume (vph)	90	410	50	140	420	150	120	455	140	60	190
Future Volume (vph)	90	410	50	140	420	150	120	455	140	60	190
Lane Group Flow (vph)	93	423	52	144	433	155	124	469	144	62	248
Turn Type	Perm	NA	Perm	pm+pt	NA	Perm	pm+pt	NA	Perm	Perm	NA
Protected Phases		2		1	6		3	8			4
Permitted Phases	2		2	6		6	8		8	4	
Detector Phase	2	2	2	1	6	6	3	8		4	4
Switch Phase											
Minimum Initial (s)	10.0	10.0	10.0	7.0	10.0	10.0	7.0	10.0	10.0	10.0	10.0
Minimum Split (s)	31.1	31.1	31.1	11.0	31.0	31.0	11.0	39.0	39.0	39.0	39.0
Total Split (s)	39.0	39.0	39.0	11.0	50.0	50.0	11.0	50.0	50.0	39.0	39.0
Total Split (%)	39.0%	39.0%	39.0%	11.0%	50.0%	50.0%	11.0%	50.0%	50.0%	39.0%	39.0%
Yellow Time (s)	4.1	4.1	4.1	4.0	4.0	4.0	4.0	4.1	4.1	4.1	4.1
All-Red Time (s)	3.0	3.0	3.0	0.0	3.0	3.0	0.0	2.9	2.9	2.9	2.9
Lost Time Adjust (s)	0.0	0.0	0.0	0.0	0.0	0.0	0.0	0.0	0.0	0.0	0.0
Total Lost Time (s)	7.1	7.1	7.1	4.0	7.0	7.0	4.0	7.0	7.0	7.0	7.0
Lead/Lag	Lag	Lag	Lag	Lead			Lead			Lag	Lag
Lead-Lag Optimize?											
Recall Mode	C-Max	C-Max	C-Max	None	C-Max	C-Max	None	Ped	Ped	Ped	Ped
Act Effct Green (s)	31.9	31.9	31.9	46.0	43.0	43.0	46.0	43.0	43.0	32.0	32.0
Actuated g/C Ratio	0.32	0.32	0.32	0.46	0.43	0.43	0.46	0.43	0.43	0.32	0.32
v/c Ratio	0.37	0.83	0.10	0.56	0.62	0.23	0.32	0.67	0.21	0.27	0.50
Control Delay	27.1	42.3	0.7	26.0	27.1	3.8	18.5	28.5	3.9	29.2	30.2
Queue Delay	0.0	0.0	0.0	0.0	0.0	0.0	0.0	0.0	0.0	0.0	0.0
Total Delay	27.1	42.3	0.7	26.0	27.1	3.8	18.5	28.5	3.9	29.2	30.2
LOS	C	D	A	C	C	A	B	C	A	C	C
Approach Delay		36.0			22.0			22.0			30.0
Approach LOS		D			C			C			C
Queue Length 50th (m)	9.5	77.7	0.0	16.2	63.7	0.0	13.7	70.8	0.0	8.9	36.4
Queue Length 95th (m)	20.5	#122.0	m0.4	28.6	95.8	11.0	24.9	106.0	10.6	20.0	59.9
Internal Link Dist (m)		309.1			142.1			493.5			927.7
Turn Bay Length (m)	50.0		80.0	40.0		80.0	90.0		50.0	40.0	
Base Capacity (vph)	253	507	503	255	694	679	386	704	672	232	494
Starvation Cap Reductn	0	0	0	0	0	0	0	0	0	0	0
Spillback Cap Reductn	0	0	0	0	0	0	0	0	0	0	0
Storage Cap Reductn	0	0	0	0	0	0	0	0	0	0	0
Reduced v/c Ratio	0.37	0.83	0.10	0.56	0.62	0.23	0.32	0.67	0.21	0.27	0.50

Intersection Summary





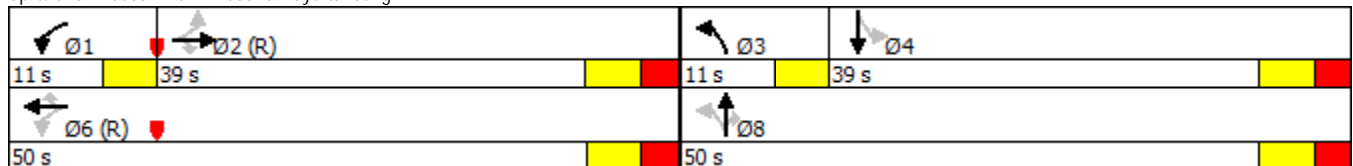





Cycle Length: 100
 Actuated Cycle Length: 100
 Offset: 77 (77%), Referenced to phase 2:EBTL and 6:WBTL, Start of Green
 Natural Cycle: 95
 Control Type: Actuated-Coordinated
 Maximum v/c Ratio: 0.83
 Intersection Signal Delay: 26.4
 Intersection Capacity Utilization 91.6%
 Analysis Period (min) 15
 # 95th percentile volume exceeds capacity, queue may be longer.
 Queue shown is maximum after two cycles.
 m Volume for 95th percentile queue is metered by upstream signal.

Splits and Phases: 6: Windsor & Bayers/Young



Halifax Transit Priority Corridors

7: Connaught & HSC

					
Lane Group	EBL	EBR	NBL	NBT	SBT
Lane Configurations					
Traffic Volume (vph)	34	271	116	316	430
Future Volume (vph)	34	271	116	316	430
Lane Group Flow (vph)	38	301	129	351	582
Turn Type	Prot	Perm	Perm	NA	NA
Protected Phases	8			6	2
Permitted Phases		8	6		
Minimum Split (s)	24.0	24.0	24.0	24.0	24.0
Total Split (s)	49.0	49.0	61.0	61.0	61.0
Total Split (%)	44.5%	44.5%	55.5%	55.5%	55.5%
Yellow Time (s)	4.0	4.0	4.0	4.0	4.0
All-Red Time (s)	2.0	2.0	2.0	2.0	2.0
Lost Time Adjust (s)	0.0	0.0	0.0	0.0	0.0
Total Lost Time (s)	6.0	6.0	6.0	6.0	6.0
Lead/Lag					
Lead-Lag Optimize?					
Act Effct Green (s)	43.0	43.0	55.0	55.0	55.0
Actuated g/C Ratio	0.39	0.39	0.50	0.50	0.50
v/c Ratio	0.06	0.41	0.40	0.43	0.38
Control Delay	21.4	4.4	21.9	19.5	16.7
Queue Delay	0.0	0.0	0.0	1.6	0.0
Total Delay	21.4	4.4	21.9	21.1	16.7
LOS	C	A	C	C	B
Approach Delay	6.3			21.3	16.7
Approach LOS	A			C	B
Queue Length 50th (m)	5.0	0.0	16.7	46.1	36.6
Queue Length 95th (m)	11.7	16.4	32.7	68.9	49.4
Internal Link Dist (m)	287.5			104.0	1112.5
Turn Bay Length (m)	50.0				
Base Capacity (vph)	612	731	322	824	1540
Starvation Cap Reductn	0	0	0	302	0
Spillback Cap Reductn	0	0	0	0	0
Storage Cap Reductn	0	0	0	0	0
Reduced v/c Ratio	0.06	0.41	0.40	0.67	0.38

Intersection Summary







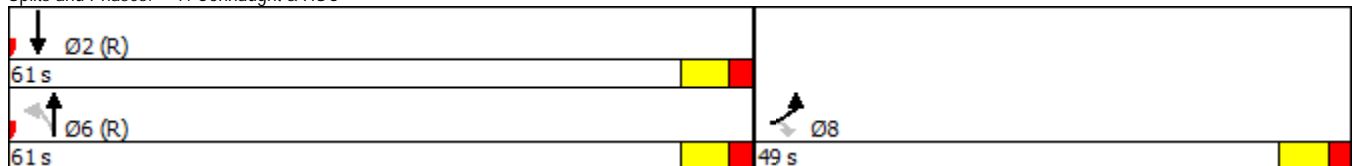



Cycle Length: 110
 Actuated Cycle Length: 110
 Offset: 0 (0%), Referenced to phase 2:SBT and 6:NBTL, Start of Green
 Natural Cycle: 50
 Control Type: Pretimed
 Maximum v/c Ratio: 0.43
 Intersection Signal Delay: 15.8
 Intersection Capacity Utilization 45.5%
 Analysis Period (min) 15

Intersection LOS: B
ICU Level of Service A

Splits and Phases: 7: Connaught & HSC



Halifax Transit Priority Corridors 2: HSC W & Bayers

						
Movement	EBT	EBR	WBL	WBT	NBL	NBR
Lane Configurations						
Traffic Volume (veh/h)	1030	150	0	2125	0	221
Future Volume (Veh/h)	1030	150	0	2125	0	221
Sign Control	Free			Free	Stop	
Grade	0%			0%	0%	
Peak Hour Factor	0.90	0.90	0.90	0.90	0.90	0.90
Hourly flow rate (vph)	1144	167	0	2361	0	246
Pedestrians						
Lane Width (m)						
Walking Speed (m/s)						
Percent Blockage						
Right turn flare (veh)						
Median type	None			None		
Median storage (veh)						
Upstream signal (m)				182		
pX, platoon unblocked					0.73	
vC, conflicting volume			1311		2324	572
vC1, stage 1 conf vol						
vC2, stage 2 conf vol						
vCu, unblocked vol			1311		2078	572
IC, single (s)			4.1		6.8	6.9
IC, 2 stage (s)						
IF (s)			2.2		3.5	3.3
p0 queue free %			100		100	47
cM capacity (veh/h)			524		34	463
Direction, Lane #	EB 1	EB 2	EB 3	WB 1	WB 2	NB 1
Volume Total	572	572	167	1180	1180	246
Volume Left	0	0	0	0	0	0
Volume Right	0	0	167	0	0	246
cSH	1700	1700	1700	1700	1700	463
Volume to Capacity	0.34	0.34	0.10	0.69	0.69	0.53
Queue Length 95th (m)	0.0	0.0	0.0	0.0	0.0	23.2
Control Delay (s)	0.0	0.0	0.0	0.0	0.0	21.2
Lane LOS						C
Approach Delay (s)	0.0			0.0		21.2
Approach LOS						C
Intersection Summary						
Average Delay			1.3			
Intersection Capacity Utilization			69.0%	ICU Level of Service		C
Analysis Period (min)			15			

Halifax Transit Priority Corridors

1: Romans & Bayers

Lane Group	EBL	EBT	EBR	WBL	WBT	WBR	NBL	NBT	NBR	SBL	SBT	SBR
Lane Configurations												
Traffic Volume (vph)	5	1785	85	0	850	5	60	60	5	20	35	40
Future Volume (vph)	5	1785	85	0	850	5	60	60	5	20	35	40
Satd. Flow (prot)	0	3031	1387	0	3096	0	1498	1544	0	0	1479	0
Fit Permitted		0.953					0.696				0.932	
Satd. Flow (perm)	0	2889	1247	0	3096	0	1045	1544	0	0	1358	0
Satd. Flow (RTOR)			80		1			3			30	
Lane Group Flow (vph)	0	1884	89	0	900	0	63	68	0	0	100	0
Turn Type	Perm	NA	Perm		NA		Perm	NA		Perm	NA	
Protected Phases		2			2			4			4	
Permitted Phases	2		2				4			4		
Total Split (s)	80.0	80.0	80.0		80.0		30.0	30.0		30.0	30.0	
Total Lost Time (s)		5.8	5.8		5.8		6.1	6.1			6.1	
Act Effct Green (s)		75.1	75.1		75.1		23.0	23.0			23.0	
Actuated g/C Ratio		0.68	0.68		0.68		0.21	0.21			0.21	
v/c Ratio		0.96	0.10		0.43		0.29	0.21			0.33	
Control Delay		29.0	1.9		4.8		40.9	36.4			29.2	
Queue Delay		0.0	0.0		0.0		0.0	0.0			0.0	
Total Delay		29.0	1.9		4.8		40.9	36.4			29.2	
LOS		C	A		A		D	D			C	
Approach Delay		27.8			4.8			38.6			29.2	
Approach LOS		C			A			D			C	
Queue Length 50th (m)		174.2	0.6		22.0		11.5	11.6			12.6	
Queue Length 95th (m)		#253.7	5.2		47.6		24.1	23.9			28.0	
Internal Link Dist (m)		76.6			386.3			826.4			535.1	
Turn Bay Length (m)			60.0				40.0					
Base Capacity (vph)		1972	876		2114		227	337			318	
Starvation Cap Reductn		0	0		0		0	0			0	
Spillback Cap Reductn		0	0		0		0	0			0	
Storage Cap Reductn		0	0		0		0	0			0	
Reduced v/c Ratio		0.96	0.10		0.43		0.28	0.20			0.31	

Intersection Summary

Cycle Length: 110
 Actuated Cycle Length: 110
 Offset: 8 (7%), Referenced to phase 2:EBWB and 6:, Start of Green
 Control Type: Actuated-Coordinated
 Maximum v/c Ratio: 0.96
 Intersection Signal Delay: 21.6
 Intersection Capacity Utilization 88.1%
 Analysis Period (min) 15
 # 95th percentile volume exceeds capacity, queue may be longer.
 Queue shown is maximum after two cycles.

Intersection LOS: C
 ICU Level of Service E

Splits and Phases: 1: Romans & Bayers

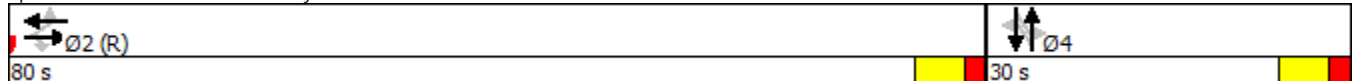

	→	↘	↙	←	↖	↗
Lane Group	EBT	EBR	WBL	WBT	NBL	NBR
Lane Configurations	↑↑	↑		↑↑	↑↘	
Traffic Volume (vph)	1800	25	0	795	35	0
Future Volume (vph)	1800	25	0	795	35	0
Satd. Flow (prot)	3131	1401	0	3131	3038	0
Fit Permitted					0.950	
Satd. Flow (perm)	3131	1401	0	3131	3038	0
Satd. Flow (RTOR)		10				
Lane Group Flow (vph)	2000	28	0	883	39	0
Turn Type	NA	Perm		NA	Prot	
Protected Phases	2			6	8	
Permitted Phases		2				
Total Split (s)	75.0	75.0		75.0	35.0	
Total Lost Time (s)	7.9	7.9		7.9	6.0	
Act Effct Green (s)	67.1	67.1		67.1	29.0	
Actuated g/C Ratio	0.61	0.61		0.61	0.26	
v/c Ratio	1.05	0.03		0.46	0.05	
Control Delay	40.0	3.4		2.5	30.5	
Queue Delay	11.8	0.0		0.1	0.0	
Total Delay	51.8	3.4		2.6	30.5	
LOS	D	A		A	C	
Approach Delay	51.2			2.6	30.5	
Approach LOS	D			A	C	
Queue Length 50th (m)	-242.5	0.2		2.9	3.2	
Queue Length 95th (m)	m#267.1	m0.4		11.4	7.4	
Internal Link Dist (m)	386.3			15.6	295.6	
Turn Bay Length (m)		25.0				
Base Capacity (vph)	1909	858		1909	800	
Starvation Cap Reductn	0	0		204	0	
Spillback Cap Reductn	52	0		0	0	
Storage Cap Reductn	0	0		0	0	
Reduced v/c Ratio	1.08	0.03		0.52	0.05	

Intersection Summary

Cycle Length: 110
 Actuated Cycle Length: 110
 Offset: 34 (31%), Referenced to phase 2:EBT and 6:WBT, Start of Green
 Control Type: Actuated-Coordinated
 Maximum v/c Ratio: 1.05
 Intersection Signal Delay: 36.3
 Intersection Capacity Utilization 73.0%
 Analysis Period (min) 15
 ~ Volume exceeds capacity, queue is theoretically infinite.
 Queue shown is maximum after two cycles.
 # 95th percentile volume exceeds capacity, queue may be longer.
 Queue shown is maximum after two cycles.
 m Volume for 95th percentile queue is metered by upstream signal.

Splits and Phases: 2: HSC W & Bayers

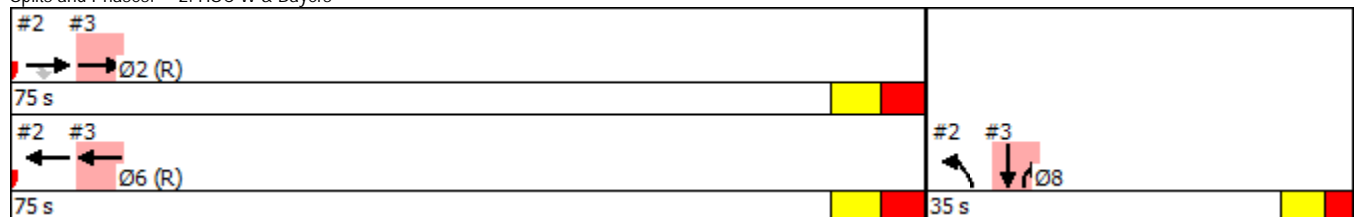

Lane Group	EBL	EBT	EBR	WBL	WBT	WBR	NBL	NBT	NBR	SBL	SBT	SBR
Lane Configurations												
Traffic Volume (vph)	0	1775	25	0	795	0	0	0	150	0	220	0
Future Volume (vph)	0	1775	25	0	795	0	0	0	150	0	220	0
Satd. Flow (prot)	0	3088	0	0	3101	0	0	0	2442	0	3131	0
Flt Permitted												
Satd. Flow (perm)	0	3088	0	0	3101	0	0	0	2442	0	3131	0
Satd. Flow (RTOR)		2							49			
Lane Group Flow (vph)	0	1875	0	0	828	0	0	0	156	0	244	0
Turn Type		NA			NA				Prot		NA	
Protected Phases		2			6				8		8	
Permitted Phases												
Total Split (s)		75.0			75.0				35.0		35.0	
Total Lost Time (s)		7.9			7.9				6.0		6.0	
Act Effct Green (s)		67.1			67.1				29.0		29.0	
Actuated g/C Ratio		0.61			0.61				0.26		0.26	
v/c Ratio		1.00			0.44				0.23		0.30	
Control Delay		9.5			10.2				22.6		33.5	
Queue Delay		18.2			0.2				0.0		0.0	
Total Delay		27.7			10.3				22.6		33.5	
LOS		C			B				C		C	
Approach Delay		27.7			10.3			22.6			33.5	
Approach LOS		C			B			C			C	
Queue Length 50th (m)		0.0			44.5				10.0		22.0	
Queue Length 95th (m)		m0.0			52.7				19.4		33.0	
Internal Link Dist (m)		15.6			119.7			310.7			66.8	
Turn Bay Length (m)												
Base Capacity (vph)		1884			1891				679		825	
Starvation Cap Reductn		85			330				0		0	
Spillback Cap Reductn		102			6				1		0	
Storage Cap Reductn		0			0				0		0	
Reduced v/c Ratio		1.05			0.53				0.23		0.30	

Intersection Summary

Cycle Length: 110
 Actuated Cycle Length: 110
 Offset: 34 (31%), Referenced to phase 2:EBT and 6:WBT, Start of Green
 Control Type: Actuated-Coordinated
 Maximum v/c Ratio: 1.05
 Intersection Signal Delay: 23.3
 Intersection Capacity Utilization 74.2%
 Analysis Period (min) 15
 m Volume for 95th percentile queue is metered by upstream signal.

Intersection LOS: C
 ICU Level of Service D

Splits and Phases: 3: HSC E & Bayers

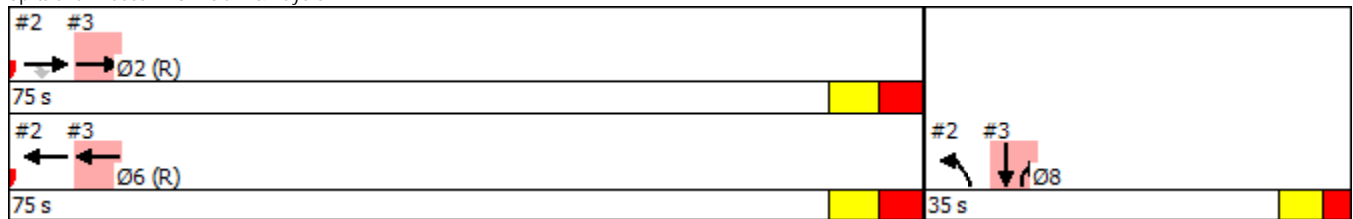

Lane Group	EBL	EBT	EBR	WBL	WBT	WBR	NBL	NBT	NBR	SBL	SBT	SBR
Lane Configurations												
Traffic Volume (vph)	325	700	900	0	481	109	162	303	90	0	185	152
Future Volume (vph)	325	700	900	0	481	109	162	303	90	0	185	152
Satd. Flow (prot)	1551	1632	1387	0	2959	1387	3008	1550	0	0	3039	2393
Fit Permitted	0.352						0.950					
Satd. Flow (perm)	569	1632	1326	0	2959	1342	3008	1550	0	0	3039	2393
Satd. Flow (RTOR)			567			151		16				
Lane Group Flow (vph)	339	729	938	0	501	114	169	410	0	0	193	158
Turn Type	pm+pt	NA	Perm		NA	Perm	Prot	NA			NA	pt+ov
Protected Phases	5	2			6		3	8			4	4 5
Permitted Phases	2		2			6						
Total Split (s)	17.0	61.0	61.0		44.0	44.0	18.0	49.0			31.0	
Total Lost Time (s)	4.0	5.9	5.9		5.9	6.9	6.0	5.2			5.2	
Act Effct Green (s)	57.6	55.7	55.7		38.1	37.1	12.0	43.2			25.2	42.8
Actuated g/C Ratio	0.52	0.51	0.51		0.35	0.34	0.11	0.39			0.23	0.39
v/c Ratio	0.81	0.88	0.99		0.49	0.21	0.52	0.66			0.28	0.17
Control Delay	14.2	15.8	25.3		26.5	3.6	52.3	32.6			36.2	22.6
Queue Delay	0.0	14.1	34.2		0.0	0.0	0.0	0.0			0.0	0.0
Total Delay	14.2	29.9	59.6		26.5	3.6	52.3	32.6			36.2	22.6
LOS	B	C	E		C	A	D	C			D	C
Approach Delay		41.1			22.2			38.3			30.1	
Approach LOS		D			C			D			C	
Queue Length 50th (m)	12.8	73.1	200.7		38.3	0.7	17.9	68.8			18.1	12.4
Queue Length 95th (m)	m15.4	m86.4	m#205.7		62.5	4.5	28.7	102.2			28.1	20.2
Internal Link Dist (m)		119.7			156.1			461.8			84.0	
Turn Bay Length (m)	90.0					60.0	110.0					35.0
Base Capacity (vph)	420	827	951		1024	552	328	626			712	854
Starvation Cap Reductn	0	99	91		0	0	0	0			0	0
Spillback Cap Reductn	0	0	0		0	0	0	0			0	0
Storage Cap Reductn	0	0	0		0	0	0	0			0	0
Reduced v/c Ratio	0.81	1.00	1.09		0.49	0.21	0.52	0.65			0.27	0.19

Intersection Summary

Cycle Length: 110
 Actuated Cycle Length: 110
 Offset: 70 (64%), Referenced to phase 2:EBTL and 6:WBT, Start of Green
 Control Type: Actuated-Coordinated
 Maximum v/c Ratio: 0.99
 Intersection Signal Delay: 36.3
 Intersection Capacity Utilization 94.7%
 Analysis Period (min) 15
 # 95th percentile volume exceeds capacity, queue may be longer.
 Queue shown is maximum after two cycles.
 m Volume for 95th percentile queue is metered by upstream signal.

Intersection LOS: D
 ICU Level of Service F

Splits and Phases: 4: Connaught & Bayers

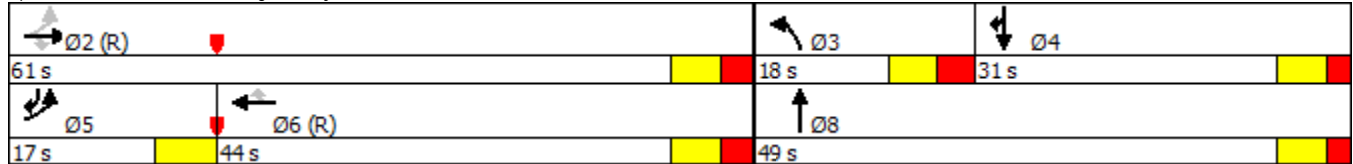

Lane Group	EBL	EBT	EBR	WBL	WBT	WBR	NBL	NBT	NBR	SBL	SBT	SBR
Lane Configurations												
Traffic Volume (vph)	0	501	206	19	304	28	99	103	36	22	103	1
Future Volume (vph)	0	501	206	19	304	28	99	103	36	22	103	1
Satd. Flow (prot)	0	1419	1085	0	1575	1374	1449	1485	0	1420	1344	0
Fit Permitted					0.960		0.685			0.573		
Satd. Flow (perm)	0	1419	1033	0	1516	1304	1018	1485	0	783	1344	0
Satd. Flow (RTOR)			215			29		15				
Lane Group Flow (vph)	0	522	215	0	337	29	103	145	0	23	108	0
Turn Type		NA	Perm	Perm	NA	Perm	Perm	NA		Perm	NA	
Protected Phases		2			6			8			4	
Permitted Phases	2		2	6		6	8			4		
Total Split (s)	78.0	78.0	78.0	78.0	78.0	78.0	32.0	32.0		32.0	32.0	
Total Lost Time (s)		5.9	5.9		5.9	5.9	5.9	5.9		5.9	5.9	
Act Effct Green (s)		81.6	81.6		81.6	81.6	16.6	16.6		16.6	16.6	
Actuated g/C Ratio		0.74	0.74		0.74	0.74	0.15	0.15		0.15	0.15	
v/c Ratio		0.50	0.26		0.30	0.03	0.67	0.61		0.19	0.53	
Control Delay		2.6	0.4		4.7	0.7	63.9	49.1		42.0	51.4	
Queue Delay		0.0	0.0		0.0	0.0	0.0	0.0		0.0	0.0	
Total Delay		2.6	0.4		4.7	0.7	63.9	49.1		42.0	51.4	
LOS		A	A		A	A	E	D		D	D	
Approach Delay		2.0			4.4			55.3			49.8	
Approach LOS		A			A			E			D	
Queue Length 50th (m)		11.1	0.0		12.6	0.0	21.2	26.5		4.4	21.7	
Queue Length 95th (m)		m13.9	m0.0		m27.1	m0.8	36.7	43.2		11.2	36.2	
Internal Link Dist (m)		259.6			309.1			518.4			229.7	
Turn Bay Length (m)			60.0			60.0	65.0			60.0		
Base Capacity (vph)		1052	821		1124	974	241	363		185	318	
Starvation Cap Reductn		0	0		0	0	0	0		0	0	
Spillback Cap Reductn		0	0		0	0	0	0		0	0	
Storage Cap Reductn		0	0		0	0	0	0		0	0	
Reduced v/c Ratio		0.50	0.26		0.30	0.03	0.43	0.40		0.12	0.34	

Intersection Summary

Cycle Length: 110
 Actuated Cycle Length: 110
 Offset: 76 (69%), Referenced to phase 2:EBTL and 6:WBTL, Start of Green
 Control Type: Actuated-Coordinated
 Maximum v/c Ratio: 0.67
 Intersection Signal Delay: 15.7
 Intersection Capacity Utilization 73.3%
 Analysis Period (min) 15
 m Volume for 95th percentile queue is metered by upstream signal.

Intersection LOS: B
 ICU Level of Service D

Splits and Phases: 5: Oxford & Bayers

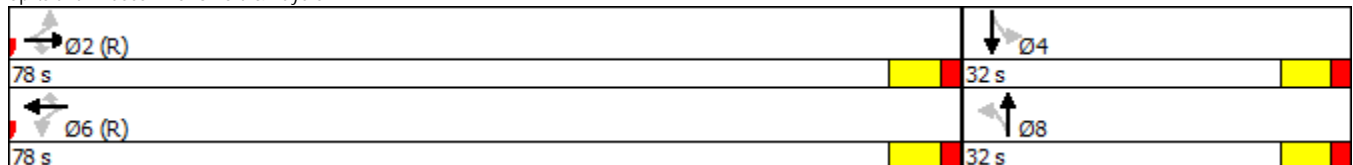

Lane Group	EBL	EBT	EBR	WBL	WBT	WBR	NBL	NBT	NBR	SBL	SBT	SBR
Lane Configurations												
Traffic Volume (vph)	52	457	79	53	243	99	76	180	151	108	436	42
Future Volume (vph)	52	457	79	53	243	99	76	180	151	108	436	42
Satd. Flow (prot)	1451	1528	0	1422	2884	0	1458	1607	1382	1473	1530	0
Fit Permitted	0.533			0.180			0.344			0.522		
Satd. Flow (perm)	814	1528	0	269	2884	0	528	1607	1350	803	1530	0
Satd. Flow (RTOR)		9			77				162		5	
Lane Group Flow (vph)	56	576	0	57	367	0	82	194	162	116	514	0
Turn Type	Perm	NA		pm+pt	NA		Perm	NA	Perm	pm+pt	NA	
Protected Phases		2		1	6			8		7	4	
Permitted Phases	2			6			8		8	4		
Total Split (s)	49.0	49.0		11.0	60.0		39.0	39.0	39.0	11.0	50.0	
Total Lost Time (s)	7.1	7.1		4.0	7.0		7.0	7.0	7.0	4.0	7.0	
Act Effct Green (s)	44.1	44.1		56.0	53.0		32.0	32.0	32.0	46.0	43.0	
Actuated g/C Ratio	0.40	0.40		0.51	0.48		0.29	0.29	0.29	0.42	0.39	
v/c Ratio	0.17	0.93		0.27	0.26		0.54	0.42	0.32	0.31	0.86	
Control Delay	12.7	42.6		17.2	13.6		47.7	34.8	6.4	22.8	45.9	
Queue Delay	0.0	0.0		0.0	0.0		0.0	0.0	0.0	0.0	0.0	
Total Delay	12.7	42.6		17.2	13.6		47.7	34.8	6.4	22.8	45.9	
LOS	B	D		B	B		D	C	A	C	D	
Approach Delay		40.0			14.1			26.7			41.7	
Approach LOS		D			B			C			D	
Queue Length 50th (m)	5.1	115.8		6.0	18.3		14.8	33.6	0.0	15.4	98.6	
Queue Length 95th (m)	m11.1	#189.4		12.7	27.7		31.8	54.5	15.0	27.5	#158.0	
Internal Link Dist (m)		309.1			142.1			569.0			312.0	
Turn Bay Length (m)	50.0			40.0			90.0		50.0	40.0		
Base Capacity (vph)	326	617		210	1429		153	467	507	378	601	
Starvation Cap Reductn	0	0		0	0		0	0	0	0	0	
Spillback Cap Reductn	0	0		0	0		0	0	0	0	0	
Storage Cap Reductn	0	0		0	0		0	0	0	0	0	
Reduced v/c Ratio	0.17	0.93		0.27	0.26		0.54	0.42	0.32	0.31	0.86	

Intersection Summary

Cycle Length: 110
 Actuated Cycle Length: 110
 Offset: 14 (13%), Referenced to phase 2:EBTL and 6:WBT, Start of Green
 Control Type: Actuated-Coordinated
 Maximum v/c Ratio: 0.93
 Intersection Signal Delay: 32.6
 Intersection Capacity Utilization 95.8%
 Analysis Period (min) 15
 # 95th percentile volume exceeds capacity, queue may be longer.
 Queue shown is maximum after two cycles.
 m Volume for 95th percentile queue is metered by upstream signal.

Splits and Phases: 6: Windsor & Bayers/Young

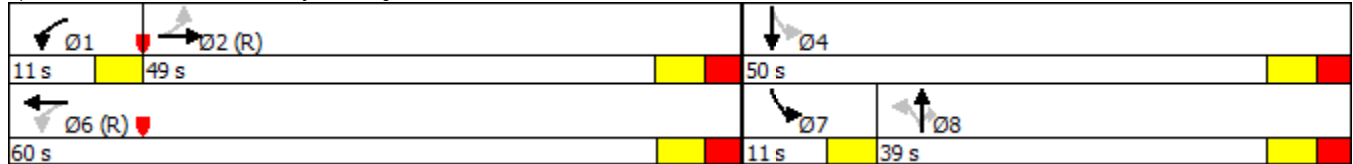

Lane Group	EBT	EBR	WBT	WBR	NBL2	NBT	SBL	SBT
Lane Configurations								
Traffic Volume (vph)	1495	115	2110	15	120	75	5	30
Future Volume (vph)	1495	115	2110	15	120	75	5	30
Lane Group Flow (vph)	1510	116	2131	22	121	91	0	308
Turn Type	NA	Perm	NA	Perm	Perm	NA	Perm	NA
Protected Phases	2		2			4		4
Permitted Phases		2		2	4		4	
Detector Phase	2	2	2	2	4	4	4	4
Switch Phase								
Minimum Initial (s)	10.0	10.0	10.0	10.0	10.0	10.0	10.0	10.0
Minimum Split (s)	23.8	23.8	23.8	23.8	29.1	29.1	29.1	29.1
Total Split (s)	94.0	94.0	94.0	94.0	36.0	36.0	36.0	36.0
Total Split (%)	72.3%	72.3%	72.3%	72.3%	27.7%	27.7%	27.7%	27.7%
Yellow Time (s)	4.1	4.1	4.1	4.1	4.1	4.1	4.1	4.1
All-Red Time (s)	1.7	1.7	1.7	1.7	2.0	2.0	2.0	2.0
Lost Time Adjust (s)	0.0	0.0	0.0	0.0	0.0	0.0	0.0	0.0
Total Lost Time (s)	5.8	5.8	5.8	5.8	6.1	6.1		6.1
Lead/Lag								
Lead-Lag Optimize?								
Recall Mode	C-Min	C-Min	C-Min	C-Min	Ped	Ped	Ped	Ped
Act Effct Green (s)	88.2	88.2	88.2	88.2	29.9	29.9		29.9
Actuated g/C Ratio	0.68	0.68	0.68	0.68	0.23	0.23		0.23
v/c Ratio	0.73	0.13	1.00	0.03	1.10	0.25		1.01
Control Delay	15.9	1.6	29.6	1.1	161.9	40.0		102.9
Queue Delay	0.0	0.0	0.0	0.0	0.0	0.0		0.0
Total Delay	15.9	1.6	29.6	1.1	161.9	40.0		102.9
LOS	B	A	C	A	F	D		F
Approach Delay	14.9		29.3			109.6		102.9
Approach LOS	B		C			F		F
Queue Length 50th (m)	118.6	0.0	-211.7	0.1	-35.0	17.7		-80.0
Queue Length 95th (m)	144.4	5.8	#344.1	m0.0	#73.9	33.1		#138.7
Internal Link Dist (m)	1417.0		385.8			886.2		555.5
Turn Bay Length (m)					40.0			
Base Capacity (vph)	2076	877	2124	775	110	357		306
Starvation Cap Reductn	0	0	0	0	0	0		0
Spillback Cap Reductn	0	0	0	0	0	0		0
Storage Cap Reductn	0	0	0	0	0	0		0
Reduced v/c Ratio	0.73	0.13	1.00	0.03	1.10	0.25		1.01

Intersection Summary

Cycle Length: 130
 Actuated Cycle Length: 130
 Offset: 57 (44%), Referenced to phase 2:EBWB and 6:, Start of Green
 Natural Cycle: 120
 Control Type: Actuated-Coordinated
 Maximum v/c Ratio: 1.10
 Intersection Signal Delay: 33.1
 Intersection Capacity Utilization 123.3%
 Analysis Period (min) 15
 ~ Volume exceeds capacity, queue is theoretically infinite.
 Queue shown is maximum after two cycles.
 # 95th percentile volume exceeds capacity, queue may be longer.
 Queue shown is maximum after two cycles.
 m Volume for 95th percentile queue is metered by upstream signal.

Splits and Phases: 1: Romans & Bayers



	→	↘	←	↙
Lane Group	EBT	EBR	WBT	NBL
Lane Configurations	↑↑	↑	↑↑	↑↘
Traffic Volume (vph)	1095	85	1760	365
Future Volume (vph)	1095	85	1760	365
Lane Group Flow (vph)	1217	94	1956	406
Turn Type	NA	Perm	NA	Prot
Protected Phases	2		6	8
Permitted Phases		2		
Detector Phase	2	2	6	8
Switch Phase				
Minimum Initial (s)	10.0	10.0	10.0	7.0
Minimum Split (s)	27.9	27.9	27.9	35.0
Total Split (s)	94.0	94.0	94.0	36.0
Total Split (%)	72.3%	72.3%	72.3%	27.7%
Yellow Time (s)	4.1	4.1	4.1	3.5
All-Red Time (s)	3.8	3.8	3.8	2.5
Lost Time Adjust (s)	0.0	0.0	0.0	0.0
Total Lost Time (s)	7.9	7.9	7.9	6.0
Lead/Lag				
Lead-Lag Optimize?				
Recall Mode	C-Min	C-Min	C-Min	Min
Act Effct Green (s)	91.3	91.3	91.3	24.8
Actuated g/C Ratio	0.70	0.70	0.70	0.19
v/c Ratio	0.55	0.09	0.89	0.70
Control Delay	16.7	8.0	7.0	55.6
Queue Delay	0.0	0.0	0.1	0.0
Total Delay	16.7	8.0	7.1	55.6
LOS	B	A	A	E
Approach Delay	16.1		7.1	55.6
Approach LOS	B		A	E
Queue Length 50th (m)	99.9	5.7	13.3	50.4
Queue Length 95th (m)	124.8	m12.9	#20.3	64.4
Internal Link Dist (m)	385.8		14.6	462.4
Turn Bay Length (m)		25.0		
Base Capacity (vph)	2199	999	2199	701
Starvation Cap Reductn	0	0	12	0
Spillback Cap Reductn	0	0	0	0
Storage Cap Reductn	0	0	0	0
Reduced v/c Ratio	0.55	0.09	0.89	0.58

Intersection Summary

Cycle Length: 130
 Actuated Cycle Length: 130
 Offset: 28 (22%), Referenced to phase 2:EBT and 6:WBT, Start of Green
 Natural Cycle: 110
 Control Type: Actuated-Coordinated
 Maximum v/c Ratio: 0.89
 Intersection Signal Delay: 15.6
 Intersection Capacity Utilization 77.6%
 Analysis Period (min) 15
 # 95th percentile volume exceeds capacity, queue may be longer.
 Queue shown is maximum after two cycles.
 m Volume for 95th percentile queue is metered by upstream signal.

Intersection LOS: B
 ICU Level of Service D

Splits and Phases: 2: HSC W & Bayers

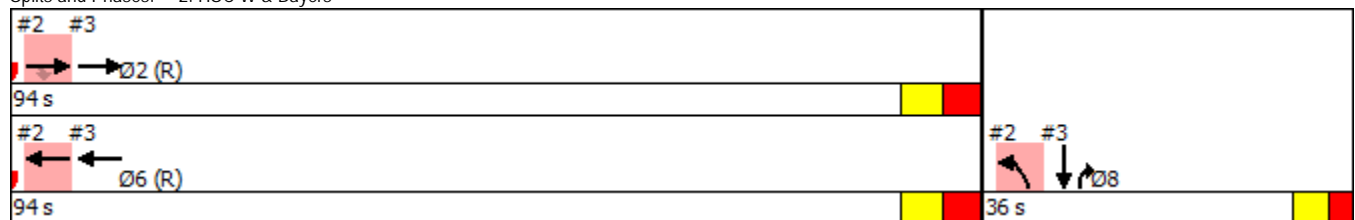

	→	←	↗	↓
Lane Group	EBT	WBT	NBR	SBT
Lane Configurations	↑↑	↑↑	↑↑	↑↑
Traffic Volume (vph)	1030	1760	255	210
Future Volume (vph)	1030	1760	255	210
Lane Group Flow (vph)	1141	1833	266	233
Turn Type	NA	NA	Prot	NA
Protected Phases	2	6	8	8
Permitted Phases				
Detector Phase	2	6	8	8
Switch Phase				
Minimum Initial (s)	10.0	10.0	7.0	7.0
Minimum Split (s)	27.9	27.9	35.0	35.0
Total Split (s)	94.0	94.0	36.0	36.0
Total Split (%)	72.3%	72.3%	27.7%	27.7%
Yellow Time (s)	4.1	4.1	3.5	3.5
All-Red Time (s)	3.8	3.8	2.5	2.5
Lost Time Adjust (s)	0.0	0.0	0.0	0.0
Total Lost Time (s)	7.9	7.9	6.0	6.0
Lead/Lag				
Lead-Lag Optimize?				
Recall Mode	C-Min	C-Min	Min	Min
Act Effct Green (s)	91.3	91.3	24.8	24.8
Actuated g/C Ratio	0.70	0.70	0.19	0.19
v/c Ratio	0.53	0.84	0.43	0.39
Control Delay	2.4	6.5	15.1	50.6
Queue Delay	0.0	2.0	0.1	0.0
Total Delay	2.4	8.5	15.2	50.6
LOS	A	A	B	D
Approach Delay	2.4	8.5		50.6
Approach LOS	A	A		D
Queue Length 50th (m)	0.0	28.0	9.0	29.0
Queue Length 95th (m)	0.0	m30.5	21.4	m37.8
Internal Link Dist (m)	14.6	119.7		121.4
Turn Bay Length (m)				
Base Capacity (vph)	2150	2178	711	722
Starvation Cap Reductn	90	205	0	0
Spillback Cap Reductn	19	14	71	0
Storage Cap Reductn	0	0	0	0
Reduced v/c Ratio	0.55	0.93	0.42	0.32

Intersection Summary

Cycle Length: 130
 Actuated Cycle Length: 130
 Offset: 28 (22%), Referenced to phase 2:EBT and 6:WBT, Start of Green
 Natural Cycle: 110
 Control Type: Actuated-Coordinated
 Maximum v/c Ratio: 0.89
 Intersection Signal Delay: 9.8
 Intersection Capacity Utilization 72.4%
 Analysis Period (min) 15
 m Volume for 95th percentile queue is metered by upstream signal.

Intersection LOS: A
 ICU Level of Service C

Splits and Phases: 3: HSC E & Bayers

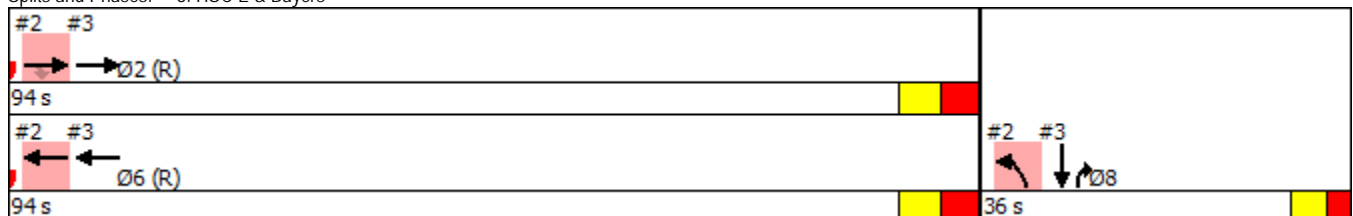

Halifax Transit Priority Corridors

4: Connaught & Bayers

Lane Group	EBL	EBT	EBR	WBT	WBR	NBL	NBT	SBT	SBR
Lane Configurations									
Traffic Volume (vph)	195	515	575	820	90	744	181	130	196
Future Volume (vph)	195	515	575	820	90	744	181	130	196
Lane Group Flow (vph)	203	536	599	854	94	775	225	135	204
Turn Type	pm+pt	NA	Perm	NA	Perm	Prot	NA	NA	pm+ov
Protected Phases	5	2		6		3	8	4	5
Permitted Phases	2		2		6				4
Detector Phase	5	2	2	6	6	3	8	4	4.5
Switch Phase									
Minimum Initial (s)	7.0	10.0	10.0	10.0	10.0	7.0	10.0	10.0	7.0
Minimum Split (s)	12.0	42.9	42.9	42.9	42.9	14.0	30.2	30.2	12.0
Total Split (s)	15.0	59.0	59.0	44.0	44.0	40.0	71.0	31.0	15.0
Total Split (%)	11.5%	45.4%	45.4%	33.8%	33.8%	30.8%	54.6%	23.8%	11.5%
Yellow Time (s)	5.0	4.1	4.1	4.1	4.1	4.0	4.1	4.1	5.0
All-Red Time (s)	0.0	2.8	2.8	2.8	2.8	3.0	2.1	2.1	0.0
Lost Time Adjust (s)	-1.0	-1.0	-1.0	-1.0	0.0	-1.0	-1.0	-1.0	-1.0
Total Lost Time (s)	4.0	5.9	5.9	5.9	6.9	6.0	5.2	5.2	4.0
Lead/Lag	Lead			Lag	Lag	Lead		Lag	Lead
Lead-Lag Optimize?									
Recall Mode	Max	C-Max	C-Max	C-Max	C-Max	Max	Ped	Ped	Max
Act Effect Green (s)	55.8	53.9	53.9	38.1	37.1	34.0	65.0	25.0	38.0
Actuated g/C Ratio	0.43	0.41	0.41	0.29	0.29	0.26	0.50	0.19	0.29
v/c Ratio	1.03	0.79	0.68	0.99	0.20	0.99	0.28	0.23	0.30
Control Delay	109.2	33.4	9.6	74.0	3.2	76.6	19.1	45.6	34.3
Queue Delay	0.0	2.6	0.2	19.8	0.0	0.0	0.0	0.0	0.0
Total Delay	109.2	36.0	9.8	93.7	3.2	76.6	19.1	45.6	34.3
LOS	F	D	A	F	A	E	B	D	C
Approach Delay		35.4		84.8			63.7	38.8	
Approach LOS		D		F			E	D	
Queue Length 50th (m)	~43.7	70.6	25.9	114.7	0.0	102.2	31.0	15.5	21.9
Queue Length 95th (m)	#89.9	117.9	31.4	#158.0	6.0	#142.8	48.2	25.1	33.1
Internal Link Dist (m)		119.7		129.2			1920.3	104.0	
Turn Bay Length (m)	90.0				60.0	110.0			35.0
Base Capacity (vph)	198	676	883	863	470	786	802	603	688
Starvation Cap Reductn	0	63	30	0	0	0	0	0	0
Spillback Cap Reductn	0	0	0	54	0	0	0	0	0
Storage Cap Reductn	0	0	0	0	0	0	0	0	0
Reduced v/c Ratio	1.03	0.87	0.70	1.06	0.20	0.99	0.28	0.22	0.30

Intersection Summary

Cycle Length: 130
 Actuated Cycle Length: 130
 Offset: 26 (20%), Referenced to phase 2:EBTL and 6:WBT, Start of Green
 Natural Cycle: 120
 Control Type: Actuated-Coordinated
 Maximum v/c Ratio: 1.03
 Intersection Signal Delay: 56.4
 Intersection Capacity Utilization 102.7%
 Analysis Period (min) 15

~ Volume exceeds capacity, queue is theoretically infinite.
 Queue shown is maximum after two cycles.

95th percentile volume exceeds capacity, queue may be longer.
 Queue shown is maximum after two cycles.

Splits and Phases: 4: Connaught & Bayers

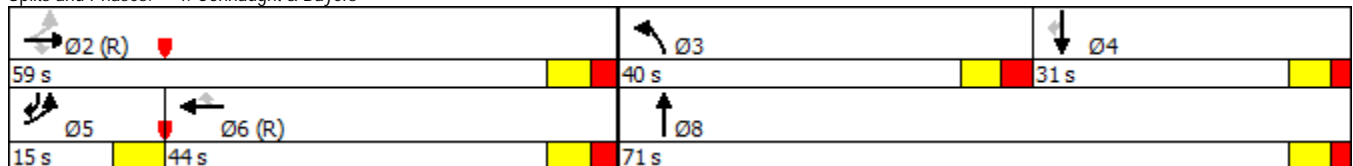

Halifax Transit Priority Corridors

5: Oxford & Bayers

Lane Group	EBL	EBT	EBR	WBL	WBT	WBR	NBL	NBT	SBL	SBT
Lane Configurations										
Traffic Volume (vph)	10	395	75	20	640	185	135	240	20	55
Future Volume (vph)	10	395	75	20	640	185	135	240	20	55
Lane Group Flow (vph)	0	409	76	0	666	187	136	282	20	61
Turn Type	Perm	NA	Perm	Perm	NA	Perm	Perm	NA	Perm	NA
Protected Phases		2			6			8		4
Permitted Phases	2		2	6		6	8		4	
Detector Phase	2	2	2	6	6	6	8	8	4	4
Switch Phase										
Minimum Initial (s)	10.0	10.0	10.0	10.0	10.0	10.0	10.0	10.0	10.0	10.0
Minimum Split (s)	24.9	24.9	24.9	24.9	24.9	24.9	23.9	23.9	23.9	23.9
Total Split (s)	61.0	61.0	61.0	61.0	61.0	61.0	39.0	39.0	39.0	39.0
Total Split (%)	61.0%	61.0%	61.0%	61.0%	61.0%	61.0%	39.0%	39.0%	39.0%	39.0%
Yellow Time (s)	4.1	4.1	4.1	4.1	4.1	4.1	4.1	4.1	4.1	4.1
All-Red Time (s)	1.8	1.8	1.8	1.8	1.8	1.8	1.8	1.8	1.8	1.8
Lost Time Adjust (s)		0.0	0.0		0.0	0.0	0.0	0.0	0.0	0.0
Total Lost Time (s)		5.9	5.9		5.9	5.9	5.9	5.9	5.9	5.9
Lead/Lag										
Lead-Lag Optimize?										
Recall Mode	C-Max	C-Max	C-Max	C-Max	C-Max	C-Max	None	None	None	None
Act Effct Green (s)		64.9	64.9		64.9	64.9	23.3	23.3	23.3	23.3
Actuated g/C Ratio		0.65	0.65		0.65	0.65	0.23	0.23	0.23	0.23
v/c Ratio		0.45	0.11		0.66	0.20	0.56	0.77	0.16	0.20
Control Delay		12.0	2.7		11.9	1.5	41.2	47.8	30.4	27.6
Queue Delay		0.0	0.0		0.0	0.0	0.0	0.0	0.0	0.0
Total Delay		12.0	2.7		11.9	1.5	41.2	47.8	30.4	27.6
LOS		B	A		B	A	D	D	C	C
Approach Delay		10.5			9.6			45.7		28.3
Approach LOS		B			A			D		C
Queue Length 50th (m)		35.4	0.0		49.9	0.0	23.4	49.8	3.1	8.8
Queue Length 95th (m)		71.1	6.0		82.6	4.8	37.9	70.0	8.6	17.2
Internal Link Dist (m)		286.5			309.1			439.9		191.0
Turn Bay Length (m)			60.0			60.0	65.0		60.0	
Base Capacity (vph)		913	678		1006	920	348	518	180	441
Starvation Cap Reductn		0	0		0	0	0	0	0	0
Spillback Cap Reductn		0	0		0	0	0	0	0	0
Storage Cap Reductn		0	0		0	0	0	0	0	0
Reduced v/c Ratio		0.45	0.11		0.66	0.20	0.39	0.54	0.11	0.14

Intersection Summary

Cycle Length: 100
 Actuated Cycle Length: 100
 Offset: 65 (65%), Referenced to phase 2:EBTL and 6:WBTL, Start of Green
 Natural Cycle: 60
 Control Type: Actuated-Coordinated
 Maximum v/c Ratio: 0.77
 Intersection Signal Delay: 18.9
 Intersection Capacity Utilization 84.1%
 Analysis Period (min) 15

Intersection LOS: B
 ICU Level of Service E

Splits and Phases: 5: Oxford & Bayers

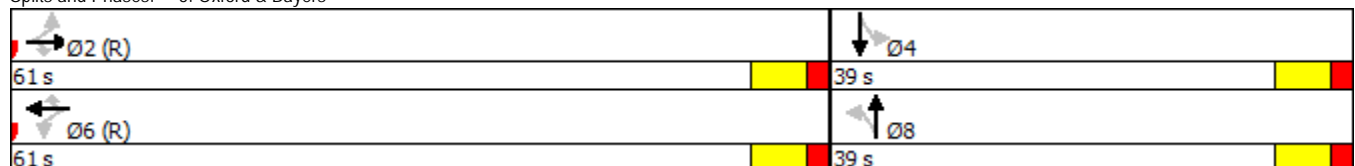

Halifax Transit Priority Corridors

6: Windsor & Bayers/Young

Lane Group	EBL	EBT	WBL	WBT	WBR	NBL	NBT	NBR	SBL	SBT
Lane Configurations										
Traffic Volume (vph)	90	410	140	420	150	120	455	140	60	190
Future Volume (vph)	90	410	140	420	150	120	455	140	60	190
Lane Group Flow (vph)	93	475	144	433	155	124	469	144	62	248
Turn Type	Perm	NA	pm+pt	NA	Perm	pm+pt	NA	Perm	Perm	NA
Protected Phases		2	1	6		3	8			4
Permitted Phases	2		6		6	8		8	4	
Detector Phase	2	2	1	6	6	3	8		4	4
Switch Phase										
Minimum Initial (s)	10.0	10.0	7.0	10.0	10.0	7.0	10.0	10.0	10.0	10.0
Minimum Split (s)	31.1	31.1	11.0	31.0	31.0	11.0	39.0	39.0	39.0	39.0
Total Split (s)	39.0	39.0	11.0	50.0	50.0	11.0	50.0	50.0	39.0	39.0
Total Split (%)	39.0%	39.0%	11.0%	50.0%	50.0%	11.0%	50.0%	50.0%	39.0%	39.0%
Yellow Time (s)	4.1	4.1	4.0	4.0	4.0	4.0	4.1	4.1	4.1	4.1
All-Red Time (s)	3.0	3.0	0.0	3.0	3.0	0.0	2.9	2.9	2.9	2.9
Lost Time Adjust (s)	0.0	0.0	0.0	0.0	0.0	0.0	0.0	0.0	0.0	0.0
Total Lost Time (s)	7.1	7.1	4.0	7.0	7.0	4.0	7.0	7.0	7.0	7.0
Lead/Lag	Lag	Lag	Lead			Lead			Lag	Lag
Lead-Lag Optimize?										
Recall Mode	C-Max	C-Max	None	C-Max	C-Max	None	Ped	Ped	Ped	Ped
Act Effect Green (s)	31.9	31.9	46.0	43.0	43.0	46.0	43.0	43.0	32.0	32.0
Actuated g/C Ratio	0.32	0.32	0.46	0.43	0.43	0.46	0.43	0.43	0.32	0.32
v/c Ratio	0.37	0.95	0.66	0.62	0.23	0.32	0.67	0.21	0.27	0.50
Control Delay	27.1	58.0	32.8	27.1	3.8	18.5	28.5	3.9	29.2	30.2
Queue Delay	0.0	0.0	0.0	0.0	0.0	0.0	0.0	0.0	0.0	0.0
Total Delay	27.1	58.0	32.8	27.1	3.8	18.5	28.5	3.9	29.2	30.2
LOS	C	E	C	C	A	B	C	A	C	C
Approach Delay		52.9		23.3			22.0			30.0
Approach LOS		D		C			C			C
Queue Length 50th (m)	9.5	90.3	16.2	63.7	0.0	13.7	70.8	0.0	8.9	36.4
Queue Length 95th (m)	20.5	#145.6	#32.3	95.8	11.0	24.9	106.0	10.6	20.0	59.9
Internal Link Dist (m)		309.1		142.1			493.5			927.7
Turn Bay Length (m)	50.0		40.0		80.0	90.0		50.0	40.0	
Base Capacity (vph)	253	501	219	694	679	386	704	672	232	494
Starvation Cap Reductn	0	0	0	0	0	0	0	0	0	0
Spillback Cap Reductn	0	0	0	0	0	0	0	0	0	0
Storage Cap Reductn	0	0	0	0	0	0	0	0	0	0
Reduced v/c Ratio	0.37	0.95	0.66	0.62	0.23	0.32	0.67	0.21	0.27	0.50

Intersection Summary

Cycle Length: 100
 Actuated Cycle Length: 100
 Offset: 77 (77%), Referenced to phase 2:EBTL and 6:WBTL, Start of Green
 Natural Cycle: 95
 Control Type: Actuated-Coordinated
 Maximum v/c Ratio: 0.95
 Intersection Signal Delay: 30.9
 Intersection Capacity Utilization 92.3%
 Analysis Period (min) 15
 # 95th percentile volume exceeds capacity, queue may be longer.
 Queue shown is maximum after two cycles.

Intersection LOS: C
 ICU Level of Service F

Splits and Phases: 6: Windsor & Bayers/Young

Ø1	Ø2 (R)	Ø3	Ø4
11 s	39 s	11 s	39 s
Ø5 (R)	Ø6	Ø7	Ø8
50 s		50 s	