



P.O. Box 1749
Halifax, Nova Scotia
B3J 3A5 Canada

Item No. 15.3
Transportation Standing Committee
June 20, 2019

TO: Chair and Members of Transportation Standing Committee

Original Signed

SUBMITTED BY:

Kelly Denty, Director Planning & Development

Original Signed

Dave Reage, Director Halifax Transit

Original Signed

Denise Schofield, Acting Chief Administrative Officer

DATE: May 15, 2019

SUBJECT: Transit Priority Corridors: Robie Street / Young Street

ORIGIN

- The *Integrated Mobility Plan* (IMP), approved at the December 5th, 2017 meeting of Regional Council, identified Robie Street and Young Street as proposed transit priority corridors, and actioned the prioritization of their delivery. In conjunction with approval of the IMP, Staff were directed to prepare a supplementary report “*amending the IMP to set the target date for implementation of the Young/Robie Transit Priority Corridors to fiscal 2020/21*”.

LEGISLATIVE AUTHORITY

Halifax Regional Municipality Charter, subsection 318(2): “In so far as is consistent with their use by the public, the Council has full control over the streets in the Municipality.”

Halifax Regional Municipality Charter, subsection 322(1): “The Council may design, lay out, open, expand, construct, maintain, improve, alter, repair, light, water, clean, and clear streets in the Municipality.”

Nova Scotia Motor Vehicle Act, subsection 90 (5) which states that “The traffic authority may (c) exclude from traffic on specified streets or specified portions of streets vehicles other than public transit vehicles or vehicles specified by the traffic authority”.

RECOMMENDATION

It is recommended that the Transportation Standing Committee recommend that Halifax Regional Council authorize the CAO to:

1. Proceed with detailed design of time-restricted (Weekdays 6AM – 6PM) curbside bus lanes on Robie Street between Young Street and Quinpool Road (Phase 1 configuration as described in the Discussion section of this report).
2. Proceed with detailed design of a westbound curbside bus lane on Young Street between Kempt Road and Windsor Street (Phase 1 configuration as described in the Discussion section of this report).
3. Initiate efforts to further investigate the right-of-way requirements necessary to accommodate continuous curbside bus lanes in both directions (Phase 2 configuration as described in the Discussion of this report) for the following roadway segments:
 - i. Robie Street (between Almon Street and Cunard Street), and
 - ii. Young Street (between Robie Street and Windsor Street).
4. Initiate efforts to further investigate the right-of-way requirements necessary for future potential construction of centre median transit lanes on Robie Street.

EXECUTIVE SUMMARY

The *Integrated Mobility Plan* (IMP), adopted by Regional Council in December 2017, identifies Robie Street and Young Street as proposed transit priority corridors based on their importance for existing and planned transit operations, as well as their potential for providing priority to transit over general traffic. The physical characteristics of the corridors, as well as how people use them, have a major influence on the type of transit priority measures that can be implemented. The IMP did not go so far as to identify the type of transit priority that would be appropriate, recognizing that there are many factors that need to be considered in determining a preferred approach.

A functional design study completed by a consultant (WSP Canada Inc.) in 2018 investigated multiple design options for transit priority upgrades on Robie Street and Young Street. The design options were evaluated based on various factors that considered the potential to improve transit operation, multimodal impacts (walking, bicycling, traffic), curbside impacts (parking, loading), implementation cost, and the feedback received from stakeholders and the public. The consultant's study recommended curbside bus lanes in both directions on both Robie Street and Young Street as the preferred configuration for implementation. Functional designs completed for preferred corridor concepts identify key impacts including the need for property acquisition and right-of-way (ROW) widening.

Based on the findings of the consultant's study and additional review by staff, this report recommends a phased approach to implementing the consultant's recommended transit priority upgrades to Robie Street and Young Street. Phase 1 includes implementation of curbside bus lanes on Robie Street (Quinpool Road to Young Street) and Young Street (Robie Street to Windsor Street) only in locations where there is existing street space that can be reallocated to serve transit. Phase 2 extends the curbside bus lanes to the remaining segments after additional investigation and necessary property acquisition is completed. The phased implementation approach is recommended in order to provide near-term transit priority benefits that can be achieved without significant cost or delay, while progress is maintained on the tasks necessary (i.e. detailed design, ROW requirements, property acquisition) to implement the full extent of the recommended transit priority upgrades. It is noted that proposed Phase 1 upgrades are recommended in their own right – though transit priority benefits of full buildout of Phase 2 represent the preferred vision for the corridor, Phase 1 upgrades provide transit priority benefits that are worthwhile even if Phase 2 is not eventually pursued.

Overall, the proposed lane configuration changes, which reduce roadway traffic capacity both mid-block and at intersections, are expected to negatively impact traffic operations on the Robie Street corridor. Traffic analysis based on weekday morning and afternoon peak periods indicates that key metrics including vehicle delay and queue length will increase for some affected movements, in some cases significantly, relative to existing conditions. Analysis also indicates that based on current traffic demand during peak periods, traffic volumes will approach or exceed the amount of available capacity for some key movements. As a result, congestion on the corridor will be expected to worsen relative to existing conditions. The analysis is based on current conditions and does not take into consideration reduction in peak demand that is expected to occur from transportation demand management, increased mode share, and future demographics and settlement patterns. Allowing congestion to worsen over the short term is consistent with the approach adopted by Council in the Integrated Mobility Plan.

With approval of the recommendations in this report, the proposed Phase 1 transit priority upgrades will move to the detailed design stage, which will provide further opportunity to refine the details of the corridor configuration. Upon completion of the detailed design process, a construction tender will be issued and awarded, subject to budget availability. Staff will also continue with ongoing work related to proposed Phase 2 upgrades, including further investigation of property acquisition requirements.

A projected implementation timeline has been developed for both the Robie Street and Young Street corridors. The recommended Phase 1 upgrades are not expected to require property acquisition or significant construction works; therefore, it is anticipated that implementation can be completed during 2020. Recommended Phase 2 upgrades will require additional investigation, property acquisition, and more extensive construction works – due to the inherent uncertainty associated with these items, implementation timelines are not currently well understood.

BACKGROUND

The *Integrated Mobility Plan* (IMP), approved by Regional Council in December 2017, identifies Robie Street and Young Street as proposed transit priority corridors, where transit should be prioritized using features that give buses an advantage over general traffic (i.e. queue jump lanes, dedicated bus lanes).

In February 2017, Regional Council directed staff to enter into a contribution agreement with the federal government, under the Public Transit Infrastructure Fund (PTIF), for a project to study and design 'Transit Priority Corridors' on Bayers Road and Gottingen Street. The total project budget is \$250,000, the cost of which is being shared evenly between the municipality and federal government. Upon project award, it was determined that there was adequate funding in the budget to expand the scope of work to include the Young Street and Robie Street TPM Corridors.

In May 2017, RFP 17-303 was awarded to WSP Canada Inc. (contract value \$133,664) to prepare functional designs for 'transit priority corridors' on Gottingen Street, Bayers Road, Robie Street, and Young Street. The Gottingen Street and Bayers Road components of the projects were completed in 2018; this report represents the conclusion of the work under RFP 17-303.

Robie Street

Robie Street runs north-south centrally across the Halifax peninsula, connecting the north and south ends over approximately 4km. A key link in the regional roadway network, it accommodates between 15,000 and 25,000 vehicles per day (depending on location along the corridor). There is considerable variation in Robie Street's cross section, ranging from a constrained two-lane section (Cunard Street to Almon Street) to wider sections with up to six lanes and centre median. Abutting land uses and neighbourhood character also vary along its length – the south end is characterized primarily by a mix of residential and institutional uses, while the north end is mostly commercial. The Halifax Common bounds the east side of Robie Street through its central portion. South of Cunard Street, Robie Street has a distinctive character, with grassed medians and mature treed boulevards. The Draft Centre Plan designates Robie Street as a 'Centre', highlighting significant development opportunities. The Centre Plan also indicates priorities for

the area as a 'Centre' including creating a more pedestrian friendly environment "*by connecting the existing street grid and improving walkability through new and expanded mobility connections*".

Transit service varies along the Robie Street corridor. The highest level of service is on the section between Cunard Street and Spring Garden Road, which is served by eight routes and more than 40 buses (two-way) during both the AM and PM peak hours. Buses on Robie Street are often subject to significant delays during peak periods, particularly during the afternoon in the outbound (northbound) direction. This corridor was also identified as a bus rapid transit (BRT) corridor in the recently completed Halifax Transit *Bus Rapid Transit (BRT) Study* (2018).

Young Street

Young Street runs east-west between Windsor Street and Gottingen Street, effectively functioning as an extension to the Bayers Road / Highway 102 corridor. It has a 4-5 lane cross section and accommodates approximately 15,000 vehicles per day. Abutting land uses are primarily a mix of commercial and high density residential. Similar to Robie Street, Young Street is designated in the Draft Centre Plan as a 'Centre', with similar opportunities and priorities.

Young Street is served by ten transit routes and up to 30 buses (two-way) during the peak hour. This corridor was also identified as a candidate BRT Corridor in the BRT Study.

Transit Priority Corridors

Robie Street and Young Street were identified as proposed transit priority corridors in the IMP based on their importance for existing and planned transit operations, as well as their potential for providing priority to transit over general traffic. The IMP did not go so far as to identify the type of transit priority that would be appropriate, recognizing that there are many factors that need to be considered in determining a preferred approach. The physical characteristics of the corridors, as well as how people use them, have a major influence on the type of transit priority measures that can be implemented. Also, as is typical with any project that involves reconfiguration of an existing street, there are trade-offs that need to be considered. Where right-of-way expansion is necessary, impacts to private property and other infrastructure (e.g. water & sewer, power / communications lines, trees) may be required. Loss of traffic lanes and curb access used for on-street parking, loading, and stopping may also be necessary.

The IMP transit priority corridor sections that are the focus of this report, highlighted in the IMP Transit Priority Corridors Map in Figure 1 below, include Young Street (Windsor Street to Robie Street) and Robie Street (Young Street to Quinpool Road). The section of Robie Street extending south from Quinpool Road to Inglis Street has been reviewed as part of the functional design process; however, staff do not presently have a recommendation for transit priority improvements for this section. While it is staff's opinion that the introduction of transit priority on this section of the roadway still has merit, it would likely have significant impacts to the existing streetscape, on-street parking, and/or traffic operations. Further analysis would be required to better understand the trade-offs in this location where transit volumes are still relatively high but congestion is lower than other parts of the corridor, and the likely benefits to transit would be lower at this time. Staff will continue to study opportunities to extend this corridor, and any detailed design completed on the section of Robie Street between Young Street and Quinpool Road would aim to ensure seamless integration with future extension of the corridor south of Quinpool Road. As illustrated in Figure 1, the proposed transit priority corridors on Robie Street and Young Street link directly to the Bayers Road bus lanes that have previously been approved by Regional Council and are currently in detailed design.

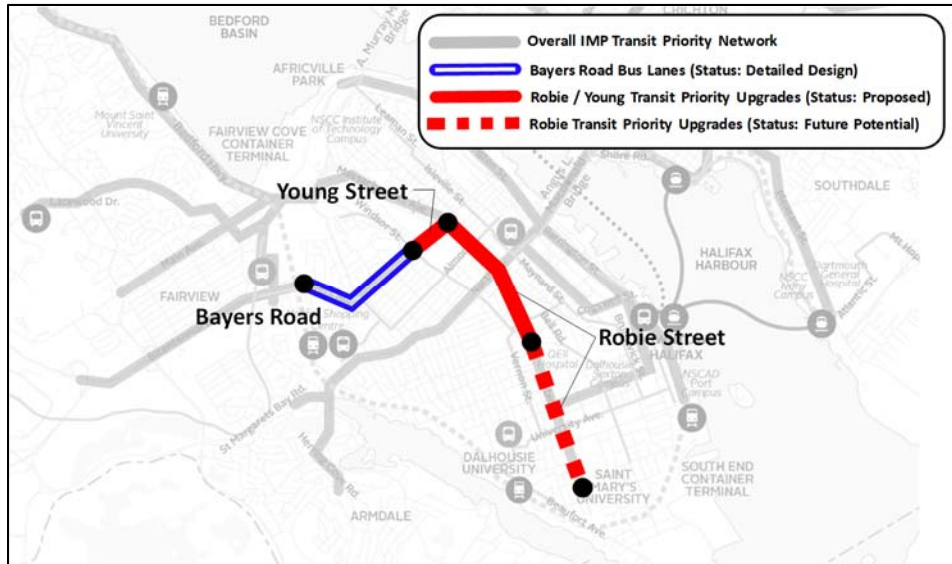

Figure 1: Proposed IMP Transit Priority Corridors (Source: IMP, Figure 20)

DISCUSSION

The primary objective of this project was to investigate transit priority options and develop functional designs for transit priority corridors on Robie Street and Young Street. The scope of the consultant's work included the following:

- Detailed investigation of existing conditions along each corridor and review of existing and projected multimodal transportation demands;
- Develop 2-3 conceptual design options representing a range of investment levels with input from the project steering committee and feedback from stakeholders;
- Public and stakeholder engagement related to the proposed design concepts;
- Identify any necessary property acquisition and utility relocation requirements for each option;
- Evaluate multimodal level of service for the options that considers factors such as transit operational benefits, intersection performance impacts, parking / curb access, and road safety.

The consultant's findings and recommendations have been summarized and are included in **Attachment A**.

Transit Priority Infrastructure

Two options for transit priority were considered for the Robie Street and Young Street corridors: (i) Curbside bus lanes and (ii) median bus lanes. Table 1 and Table 2 provide a description and summary of key advantages and disadvantages for each.

Table 1: Curbside Bus Lanes - Overview



| Curbside Bus Lanes | |
|---|--|
| <p>Description:</p> <ul style="list-style-type: none"> Curb lane(s) are designated for use by buses only; Bus lanes are designated with regulatory signage and diamond pavement markings; Typically, right turning vehicles are permitted to use the bus lane on approaches to intersections (regulatory signage indicates "right turn except buses"); Passenger boarding/alighting is done from the side of the street, as per existing conditions; Bicycles may be permitted to operate in the bus lane; Typically, bus lanes necessitate removal of parking and/or traffic lanes; however, in some cases these uses <i>may</i> be considered in a bus lane during off-peak periods. |  |
| <p>Where are they Most Suitable?</p> <ul style="list-style-type: none"> Streets with high volumes of transit service that experience traffic congestion; Streets with excess lane capacity and/or good potential for street widening. Streets without significant right turning demand at intersections. | |
| <p>Advantages / Benefits:</p> <ul style="list-style-type: none"> Dedicated space allows buses to bypass traffic congestion, reducing delay and improving service reliability; Traffic not impacted by stopped buses; Relatively easy to integrate operations with existing traffic signal phasing and bus stops; and Provide flexibility to modify curb access outside of peak periods to allow other uses (i.e. parking, loading). | <p>Disadvantages / Challenges:</p> <ul style="list-style-type: none"> Typically requires removal of traffic lane capacity and/or on-street parking; Where right turns are permitted by general traffic, buses may experience delay at intersections; and Where ROW is constrained, may require street widening and property acquisition. |

Table 2: Median Bus Lanes - Overview

| Median Bus Lanes | |
|--|---|
| <p>Description:</p> <ul style="list-style-type: none"> Centre lane(s) are designated for use by buses only; Bus lanes are designated with regulatory signage and diamond pavement markings; Bus stops are located on curbed islands within the street ROW. Passengers cross travel lanes to board/alight; |  |
| <p>Where are they Most Suitable?</p> <ul style="list-style-type: none"> Streets with high volumes of transit service that experience traffic congestion; Streets with excess lane capacity and/or good potential for street widening; and Streets with low left turning demand or where prohibition of left turns may be acceptable | |
| <p>Advantages / Benefits:</p> <ul style="list-style-type: none"> Dedicated space allows buses to bypass traffic congestion, reducing delay and improving service reliability; Buses are not delayed by right turning vehicles at intersections; Provide flexibility to modify curb access outside of peak periods to allow other uses (i.e. parking, loading). | <p>Disadvantages / Challenges:</p> <ul style="list-style-type: none"> Typically requires removal of traffic lane capacity and/or on-street parking or expansion of the ROW; Bus stop islands increase ROW needs. Where ROW is constrained, may require street widening and property acquisition. User experience impacted, as passengers must cross traffic lanes to access bus stops and wait on a median; May require prohibition of left turns at intersections; Require prohibition of left turns into driveways; Requires modification of traffic signal phasing to incorporate |

Robie Street

The physical characteristics of Robie Street vary significantly along its length. South of Cunard Street, the cross section is generally wide, with four to six traffic lanes and a centre median. Between Almon Street and Cunard Street, the cross-section is reduced to three lanes and the total street ROW narrows considerably. North of Almon Street, Robie Street widens to a five-lane cross section. An overview of the physical and operational characteristics of the corridor is provided in Table 3.

Table 3: Robie Street Overview

| Segment | Description |
|--------------------------------|--|
| Young Street to Almon Street | Cross Section: 5 lanes, undivided Vehicular Traffic: 28,000 vehicles per day Transit: 25 2-way buses per hour (existing peak) On-Street Parking Spaces: 0 |
| Almon Street to Cunard Street | Cross Section: 2-3 lanes, undivided Vehicular Traffic: 28,000 vehicles per day Transit: 25 2-way buses per hour (existing peak) On-Street Parking Spaces: 21 |
| Cunard Street to Quinpool Road | Cross Section: 5 lanes, median divided Vehicular Traffic: 24,000 vehicles per day Transit: 40 2-way buses per hour (existing peak) On-Street Parking Spaces: 36 |

Functional design was completed for two core options for Robie Street: (i) curbside bus lanes and (ii) centre median bus lanes (functional design drawings are provided in **Attachment B**). The objective of the functional design process was to investigate the feasibility of each option and understand the potential implications for key operational aspects of the street including transit benefits, traffic / parking impacts, and impacts to the pedestrian realm. Identification of any need to expand the existing ROW is also a critical part of the design process. The following sections provide a summary of the two core options considered for Robie Street.

- *Option 1 – Curbside Bus Lanes:* Addition of curbside bus lanes on Robie Street can be completed with varying levels of impact. On the widest segments (i.e. north of Almon Street, Cunard Street to Quinpool Road), bus lanes can be added on both sides of Robie Street by reconfiguring the existing curb-to-curb space. The narrowest segment (Almon Street to Cunard Street) is considerably more challenging and would require widening / property acquisition to accommodate curbside bus lanes on both sides of the street.

Impacts associated with curbside bus lanes for each section of Robie Street are summarized in Table 4 and described below:

- Transit: Transit benefits associated with curbside bus lanes are expected to be significant, particularly in the most congested areas. Schedule adherence data indicate that average bus travel time on Robie Street during peak periods currently increases by up to 40% (inbound, AM Peak) and by up to 60% (outbound, PM peak) relative to off-peak periods.
- Traffic: Traffic analysis was completed to assess the impacts of the potential removal of traffic lanes on Robie Street. On segments where it was determined that traffic lanes can be removed without significant impacts (i.e. north of Almon Street, Cunard Street to Quinpool Road), lane space was reallocated. For segments where a loss of traffic lanes would result in

significant impacts, street widening or reallocation of centre median space is an alternative option that can be considered to add curbside bus lanes.

- Right-of-way: To add curbside bus lanes in both directions on Robie Street, the functional design indicates that property acquisition and ROW widening will be required. The majority of impacts would be on the constrained section between Almon Street and Cunard Street.
- Parking/Loading: It would be necessary to remove all on-street street parking on Robie Street during periods when the bus lanes are operational. This amounts to a total potential loss of up to 57 parking spaces (see Table 4). Consideration could be given to allowing on-street parking during off-peak periods when the bus lanes are less critical, similar to the recently installed bus lane on Gottingen Street.
- Pedestrian Realm: Increased pedestrian crossing distance in locations where street widening is required.

Table 4: Summary of Key Impacts – Curbside Bus Lanes

| | Segment | Impacts | | |
|--------------------|--------------------------------|--|---|--------------------------|
| | | Traffic | Right-of-way | Parking |
| Curbside Bus Lanes | Young Street to Almon Street | Loss of two lanes (one each direction) | N/A | No change |
| | Almon Street to Cunard Street | Loss of one lane (northbound) | Significant road widening, property acquisition | Loss of up to 21 spaces* |
| | Cunard Street to Quinpool Road | Loss of two lanes (one each direction) | <u>OR</u> (<u>OR</u> road widening, property acquisition) | Loss of up to 36 spaces* |

* On-street parking could be permitted if/when the bus lane is not in effect (i.e. outside of peak periods).

- *Option 2 – Centre Median Bus Lanes*: Centre median bus lanes represent a more transformative change to the overall functionality of Robie Street, and the associated impacts are significant. Width requirements of the centre median bus lanes option are greater than those for curbside bus lanes due to the need to add passenger waiting areas within the street ROW. As a result, widening and property acquisition would be required along much of the corridor. Impacts associated with centre median bus lanes for each section of Robie Street are summarized in Table 5 and described below:

- Transit: Transit operation would change significantly with centre median bus lanes, both in terms of how buses move through the corridor and how passengers access the service:
 - Running down the centre of Robie Street would provide buses a truly dedicated space that is free of direct interaction with right turning vehicles, potentially resulting in significant improvements over curb operations.
 - Passengers would board and alight via stops located on platforms within the street ROW; therefore, crossing Robie Street traffic lanes would be required.
 - Although centre median bus lanes offer significant potential for transit improvement on Robie Street, intersection operation is a key limiting factor. In order for buses running in the centre median lanes to operate effectively, it would likely be necessary to prohibit (or significantly impact the operation of) traffic making left turns from Robie Street at intersections and driveways. Given the central location of Robie Street and heavy volume of traffic turning left in either direction, this would have a significant impact on traffic patterns on the peninsula. Traffic analysis completed for the centre median lanes option indicated that without prohibition of left turns, overall benefits to transit would be expected to be negligible.
 - Added benefits that are perhaps less tangible include the added ‘visibility’ of transit priority and improved perception by users as a ‘higher order’ transit service. The centre median lane would provide strong opportunity for integration with Halifax Transit’s BRT service plans. As a long-term consideration, centre median lanes could provide the footprint and base infrastructure necessary to facilitate higher order

transit in the future. As a long-term consideration, centre median lanes could provide the footprint and base infrastructure necessary to facilitate higher order transit in the future.

- **Traffic:** In order for centre median transit lanes to provide the intended priority to transit flow, significant impacts to traffic would be required. Left turn prohibition or restriction, which would likely be required at several intersections and driveways to reduce intersection delay for all users (including buses), would result in significant impacts to traffic flow and circulation on the peninsula road network. The proposed lane configuration changes, which reduce roadway traffic capacity both mid-block and at intersections, are expected to negatively impact traffic operations. Traffic analysis based on weekday morning and afternoon peak periods indicates that key metrics including vehicle delay and queue length will increase for some affected movements, in some cases significantly, relative to existing conditions. Analysis also indicates that based on current traffic demand during peak periods, traffic volumes will approach or exceed the amount of available capacity for some key movements. As a result, congestion on the corridor will be expected to worsen relative to existing conditions. A substantial shift in mode share from auto-based trips to transit, which could be possible with this type of facility (as part of a connected transit priority network), would help to mitigate the potential for significant traffic congestion.
- **Right-of-way:** To add median bus lanes on Robie Street, the functional design indicates that significant ROW widening (and associated property acquisition) will be required. The segments between Young Street and Cunard Street are most affected; the functional design for this option indicates that several properties would be likely to be extensively impacted. It is anticipated that efforts to acquire the necessary lands would require a real estate acquisition strategy to be implemented over multiple years.
- **Parking:** On-street parking would be removed on a full-time basis for all segments that are reduced to a single traffic lane. This amounts to a total potential loss of up to 57 parking spaces (see Table 5). Consideration could be given to allowing on-street parking during off-peak periods in the curb lane where there is more than one traffic lane.
- **Pedestrian Realm:** Increased pedestrian crossing distance in locations where street widening is required. Also, this configuration would require that transit passengers wait for the bus on a concrete island within the roadway, which may be less comfortable than waiting on the sidewalk.

Table 5: Summary of Key Impacts – Centre Median Bus Lanes

| | Segment | Impacts | | |
|-------------------------|--------------------------------|--|---|--------------------------|
| | | Traffic | Right-of-way | Parking |
| Centre Median Bus Lanes | Young Street to Almon Street | Loss of three lanes (1 northbound, 2 southbound) Restriction of left turn movements | Minor road widening, potential property acquisition | No change |
| | Almon Street to Cunard Street | Loss of one lane (northbound) Restriction of left turn movements | Significant road widening, property acquisition | Loss of up to 21 spaces* |
| | Cunard Street to Quinpool Road | Loss of two lanes (one each direction) Restriction of left turn movements | Modified centre median Minor road widening, potential property acquisition | Loss of up to 36 spaces* |

* Where multiple traffic lanes are present in one direction, on-street parking could be permitted in the curb lane outside of peak periods.

Young Street

An overview of the physical and operational characteristics of Young Street corridor is provided in Table 6.

Table 6: Young Street Overview

| Segment | Windsor Street to Kempt Road | Kempt Road to Robie Street |
|-------------|--|--|
| Description | Cross Section: 4 lanes, undivided AADT: 15,000 vehicles per day Transit: 17 2-way buses per hour (existing peak) | Cross Section: 5 lanes, undivided AADT: 15,000 vehicles per day Transit: 25 2-way buses per hour (existing peak) |

Functional design was completed for two options for Young Street: (i) curbside bus lanes (eastbound and westbound) and (ii) curbside bus lane (westbound only). The following sections provide a summary of the two core options considered for Young Street.

- **Option 1 – Curbside Bus Lanes (eastbound and westbound):** Addition of two curbside bus lanes on Young Street would require widening / property acquisition along the entire segment between Windsor Street and Robie Street. It would also require changes to existing traffic lane configurations. Impacts associated with option 1 for Young Street are described below:
 - **Transit:** Curbside bus lanes in both directions will improve transit operation for inbound and outbound buses, particularly during both the morning and afternoon peak traffic periods. The Young Street bus lanes will effectively extend the proposed Bayers Road bus lanes, which (when constructed) will extend to Windsor Street.
 - **Traffic:** The existing 4-lane cross section (two lanes inbound, two lanes outbound) would be reduced to three traffic lanes (one lane inbound, one lane outbound, alternating left turn lane). The proposed lane configuration changes, which reduce roadway traffic capacity both mid-block and at intersections, are expected to negatively impact traffic operations. Traffic analysis based on weekday morning and afternoon peak periods indicates that key metrics including vehicle delay and queue length will increase for some affected movements, in some cases significantly, relative to existing conditions. Analysis also indicates that based on current traffic demand during peak periods, traffic volumes will approach or exceed the amount of available capacity for some key movements. As a result, congestion on the corridor will be expected to worsen relative to existing conditions.
 - **Right-of-way:** To add curbside bus lanes in both directions on Young Street, the functional design indicates that ROW widening (and associated property acquisition) will be required.
 - **Parking:** No impact (parking is not currently permitted on Young Street).
 - **Pedestrian Realm:** Increased pedestrian crossing distance in locations where street widening is required.

- **Option 2 – Curbside Bus Lanes (westbound only):** Addition of an outbound curbside bus lane on Young Street can be achieved with minimal (if any) widening / property acquisition. However, it would require similar changes to existing traffic lane configurations to those described in Option 1. Impacts associated with option 2 for Young Street are described below:

- Transit: A curbside bus lane in the westbound direction will improve transit operation for outbound buses, particularly during the afternoon peak traffic period. A westbound Young Street bus lane would tie directly to the proposed Bayers Road westbound bus lane, which (when constructed) will extend to Windsor Street. Eastbound buses will not benefit from transit priority based on this configuration.
- Traffic: Similar to Option 1, the existing 4-lane cross section (two lanes inbound, two lanes outbound) would be reduced to three traffic lanes (one lane inbound, one lane outbound, alternating left turn lane). The proposed lane configuration changes, which reduce roadway traffic capacity both mid-block and at intersections, are expected to negatively impact traffic operations during weekday morning and afternoon peak periods. As a result, congestion on the corridor will be expected to worsen relative to existing conditions.
- Right-of-way: To add a westbound bus lane on Young Street, the functional design indicates that ROW widening (and associated property acquisition) may be required near the Kempt Road intersection.
- Parking: No impact (parking is not currently permitted on Young Street).
- Pedestrian Realm: No notable change to the pedestrian realm.

Centre median bus lanes are not currently being considered as an option on Young Street, as curbside bus lanes are expected to provide sufficient transit priority on the relatively short segment and are consistent with the transit priority configuration that is being implemented on the adjoining Bayers Road corridor.

Proposed Approach: Robie Street and Young Street

The results of the functional design process indicate that there is strong potential to add continuous transit priority to Robie Street and Young Street. However, it is also evident that there are major constraints – primarily ROW acquisition requirements – that limit the ability to add a complete transit priority solution in the near term. Given the importance of transit priority on these corridors to the goals of the IMP and Moving Forward Together Plan (MFTP), it is important that options be considered that achieve immediate benefits while continuing to work toward the ultimate solution. Accordingly, staff recommend a phased approach that would provide incremental benefits while working toward an ultimate solution.

A summary of the proposed phased approach to implementation for transit priority upgrades on Robie Street and Young Street is described below and illustrated in Figure 2.

- *Phase 1 (Implementation – 2020):*
 - Young Street:
 - Add a curbside bus lane (westbound only) on Young Street between Kempt Road and Windsor Street;
 - Robie Street:
 - Add curbside bus lanes to both sides of Robie Street (i) between Young Street and Almon Street and (ii) between Cunard Street and Quinpool Road;
 - Add a curbside bus lane (northbound only) on Robie Street between Almon Street and Cunard Street.
- *Phase 2 (Implementation timeline to be determined):*
 - Subject to approval of budget and resource plan, initiate efforts to further investigate and acquire, where possible, the property required to expand the ROW to facilitate addition of curbside bus lanes on the following segments:
 - Young Street (Windsor Street to Kempt Road): Eastbound bus lane, to complement the westbound bus lane recommended for implementation in Phase 1.
 - Robie Street (Almon Street to Cunard Street): Southbound bus lane, to complement the northbound bus lane recommended for implementation in Phase 1.
 - Construct the above noted curbside bus lanes as the necessary lands are acquired and become available.

- *Optional:* Add curbside bus lanes to both sides of Robie Street between Quinpool Road and University Avenue. Though it appears that there is sufficient space within the street ROW to add the bus lanes without property acquisition, repurposing of the centre median and the loss of on-street parking (and/or traffic lanes) would be required. At this time, the incremental benefit of extending transit priority south of Quinpool Road is still under consideration as it is likely there would be considerable impact to other uses in the street ROW.

➤ *Long Term:*

- Subject to approval of budget and resource plan, initiate efforts to further investigate the property required to widen the street to facilitate addition of centre median bus lanes between Young Street and University Avenue. Acquisition and preservation of this corridor is considered a strategic long-term objective that will provide the Municipality the opportunity to potentially add higher order transit services such as centre running Bus Rapid Transit or light rail in the future.

Staff are currently in the process of reviewing the land requirements and developing a potential real estate acquisition strategy; it is anticipated that this process will require several years and have significant cost implications. However, given the Robie Street corridor's strategic location along the centre of the peninsula, these efforts are expected to be warranted.

It is noted that proposed Phase 1 upgrades are recommended in their own right – though transit priority benefits of full buildout of Phase 2 represent the preferred vision for the corridor, Phase 1 upgrades provide transit priority benefits that are worthwhile even if Phase 2 is not eventually pursued.

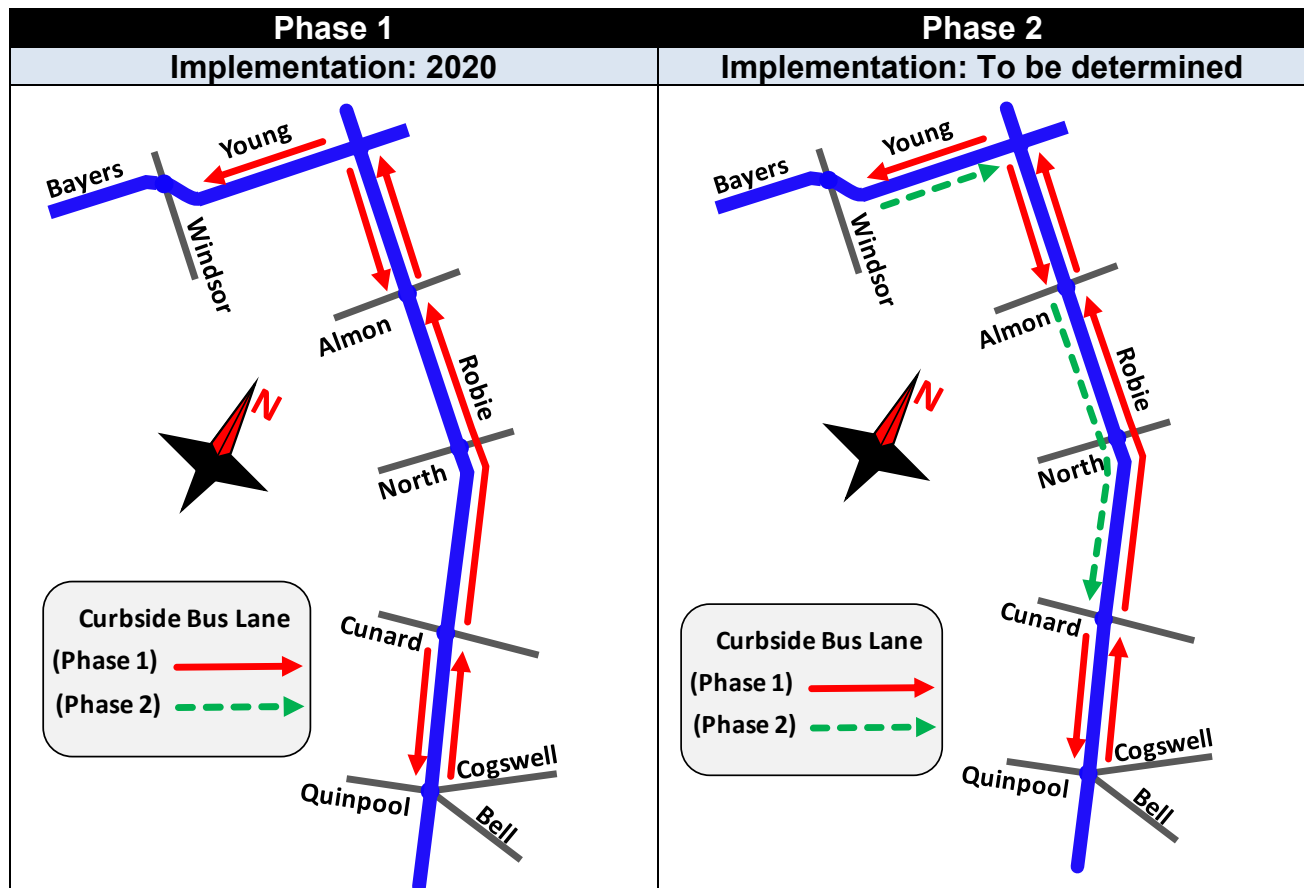

Figure 2: Proposed Configuration / Phasing - Robie Street Transit Priority Corridor

Proposed Phase 1 Details

This section provides further details related to the proposed Phase 1 transit priority upgrades for Robie Street and Young Street, including cross sections for each segment, key operational changes, intersection upgrades, and a summary of the associated impacts.

- **Cross Sections:** Existing and proposed cross sections for each affected segment are presented in the following tables

Table 7: Proposed Street Configuration Options – Young Street (Windsor Street to Kempt Road)

| Existing Conditions | |
|---|--|
| <p style="text-align: center;">Young Street (looking to the east)</p> | |
| Phase 1: Westbound Curbside Transit Lane | |
| <p style="text-align: center;">Young Street (looking to the east)</p> | |
| Summary of Changes | |
| <ul style="list-style-type: none"> • Transit: Designate existing westbound curb lane as a dedicated bus lane (also permitted for use by right turning vehicles); • Traffic: Loss of one westbound and one eastbound traffic lane, and conversion of one lane to a two-way left turn lane. Young Street accommodates average annual weekday traffic (AADT) of approximately 15,000 vehicles per day (vpd), which is within typically acceptable ranges for 'road diet' configurations of this type (15,000 to 24,000 vpd). | <ul style="list-style-type: none"> • Parking: There is currently no on-street parking on this segment of Young Street. • Right-of-way: Transit road ROW widening may be required near of the Kempt Road intersection; however, it is anticipated that the majority of changes are possible within existing curb-to-curb width. |

Table 8: Proposed Street Configuration Options – Robie Street (Young Street to Almon Street)

| Existing Conditions | | |
|---|---|--|
|  <p style="text-align: center;">Robie Street (looking to the north)</p> |  | |
| Phase 1/2: Northbound / Southbound Curbside Transit Lanes | | |
|  <p style="text-align: center;">Robie Street (looking to the north)</p> | | |
| Summary of Changes | | |
| <ul style="list-style-type: none"> Transit: Designate existing northbound and southbound curb lanes as dedicated bus lanes (also permitted for use by right turning vehicles); Traffic: Loss of one northbound and one southbound traffic lane. The proposed lane configuration changes, which reduce roadway traffic capacity both mid-block and at intersections, are expected to negatively impact traffic operations. Analysis indicates that based on current traffic demand during peak periods, traffic volumes will approach or exceed the amount of available capacity for some key movements. As a result, congestion on the corridor will be expected to worsen relative to existing conditions. | <ul style="list-style-type: none"> Parking: There is currently no on-street parking on this segment. Consideration could be given to permitting time-restricted on-street parking within the bus lane during evenings, overnight, and on weekends; Right-of-way: Transit road ROW widening is not required; all changes are within existing curb-to-curb width. | |

Table 9: Proposed Street Configuration Options – Robie Street (Almon Street to Cunard Street)

| Existing Conditions | |
|---|--|
|  <p style="text-align: center;">Robie Street (looking to the north)</p> |  |
| <h3 data-bbox="181 831 959 871">Phase 1: Northbound Curbside Transit Lane</h3>  <p style="text-align: center;">Robie Street (looking to the north)</p> | |
| <h3 data-bbox="181 1409 1448 1459">Summary of Changes</h3> | |
| <ul style="list-style-type: none"> • Transit: Designate existing northbound curb lane as a dedicated bus lane (also permitted for use by right turning vehicles); • Traffic: Loss of one northbound traffic lane. The proposed lane configuration changes, which reduce roadway traffic capacity both mid-block and at intersections, are expected to negatively impact traffic operations. Analysis indicates that based on current traffic demand during peak periods, traffic volumes will approach or exceed the amount of available capacity for some key movements. As a result, congestion on the corridor will be expected to worsen relative to existing conditions. | <ul style="list-style-type: none"> • Parking: Removal of all on-street parking (up to 21 spaces) and loading while bus lane is operational. Parking can be accommodated within the bus lane outside of operational periods; • Right-of-way: Transit road ROW widening is not required; all changes are within existing curb-to-curb width. |

Table 10: Proposed Street Configuration Options – Robie Street (Cunard Street to Quinpool Road)

| Existing Conditions | | |
|--|--|--|
|  <p style="text-align: center;">Robie Street (looking to the north)</p> |  | |
| Phase 1/2: Northbound / Southbound Curbside Transit Lanes | | |
|  <p style="text-align: center;">Robie Street (looking to the north)</p> | | |
| Summary of Changes | | |
| <ul style="list-style-type: none"> • Transit: Designate existing northbound and southbound curb lanes (also permitted for use by right turning vehicles); • Traffic: Loss of one northbound and one southbound traffic lane. The proposed lane configuration changes, which reduce roadway traffic capacity both mid-block and at intersections, are expected to negatively impact traffic operations. Analysis indicates that based on current traffic demand during peak periods, traffic volumes will approach or exceed the amount of available capacity for some key movements. As a result, congestion on the corridor will be expected to worsen relative to existing conditions. | <ul style="list-style-type: none"> • Parking: Removal of all on-street parking (up to 36 spaces) and loading while bus lane is operational. Parking can be accommodated within the bus lane outside of operational periods; • Right-of-way: Transit road ROW widening is not required; all changes are within existing curb-to-curb width. | |

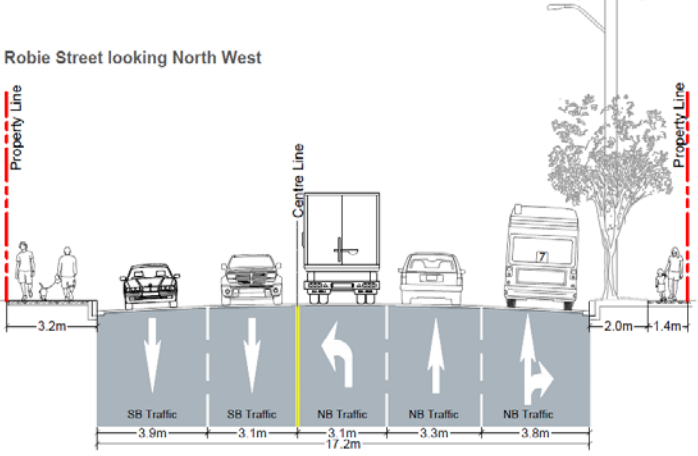
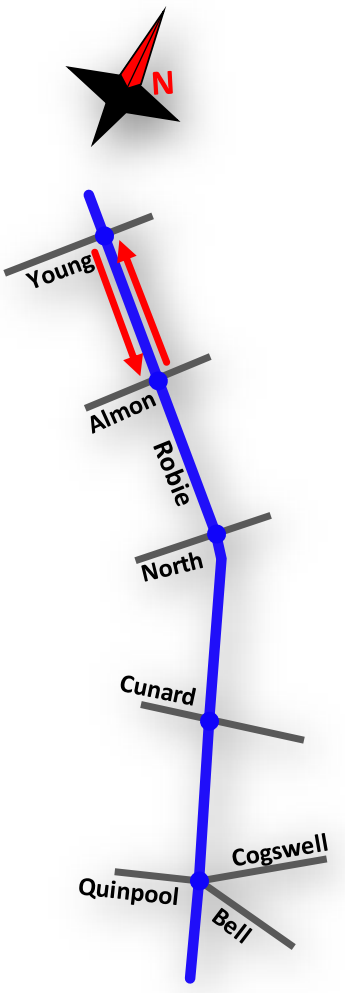
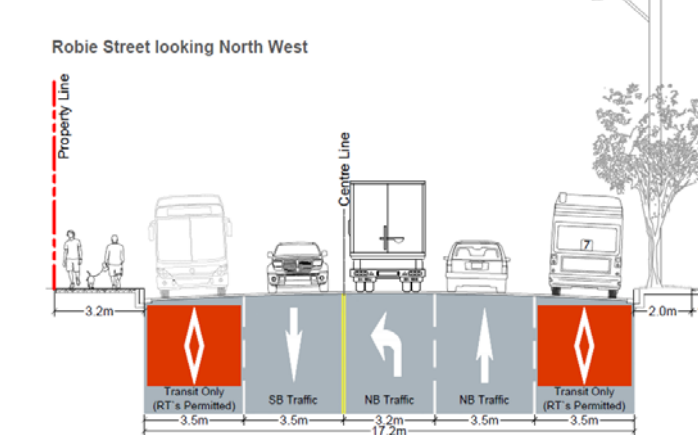
- **Intersections:** Proposed changes at intersections and the anticipated impacts are summarized in Table 11. Traffic impact analysis was completed to evaluate these intersection changes – results are summarized in **Attachment C**.

Overall, the proposed lane configuration changes, which reduce roadway traffic capacity both mid-block and at intersections, are expected to negatively impact traffic operations on the Robie Street corridor. Traffic analysis based on weekday morning and afternoon peak periods indicates that key metrics including vehicle delay and queue length will increase for some affected movements, in some cases significantly, relative to existing conditions. Analysis also indicates that based on current traffic demand during peak periods, traffic volumes will approach or exceed the amount of available capacity for some key movements. As a result, congestion on the corridor will be expected to worsen relative to existing conditions.

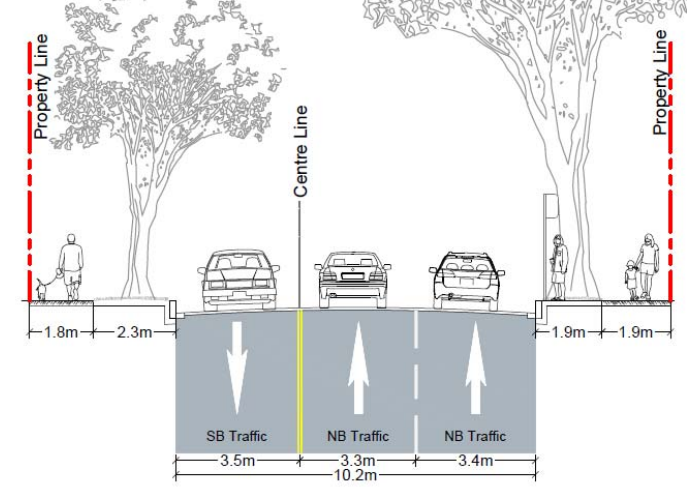
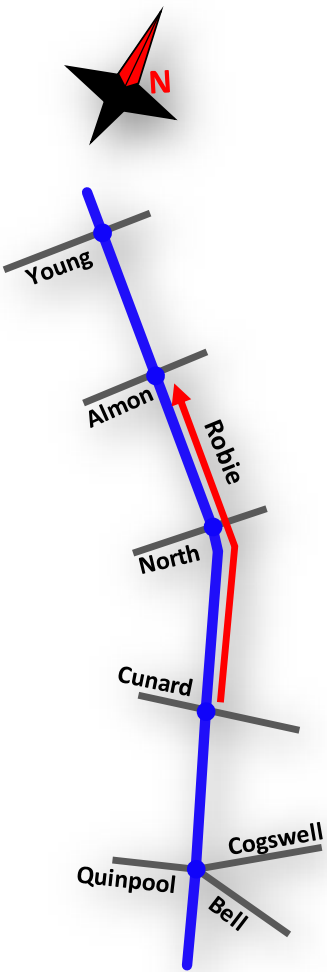
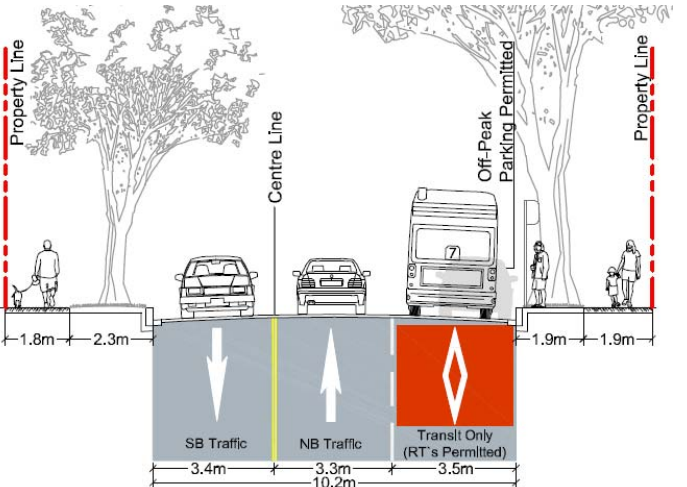
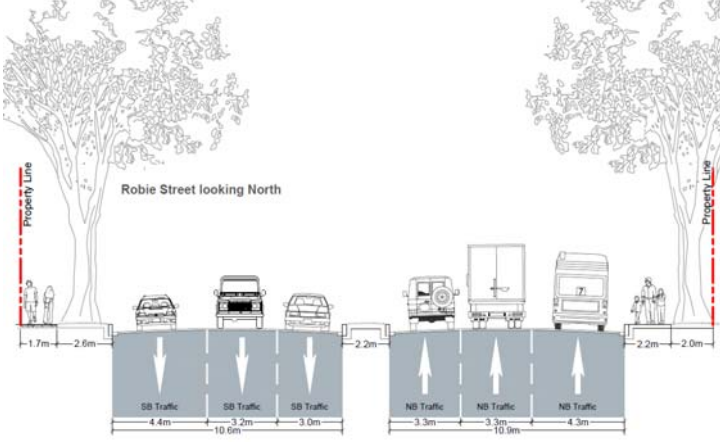
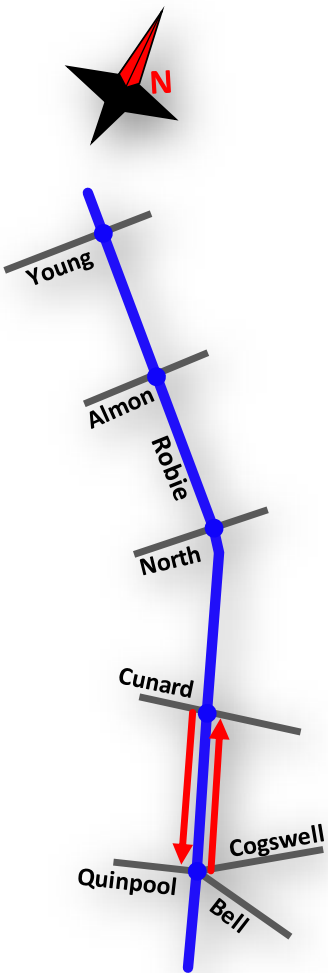
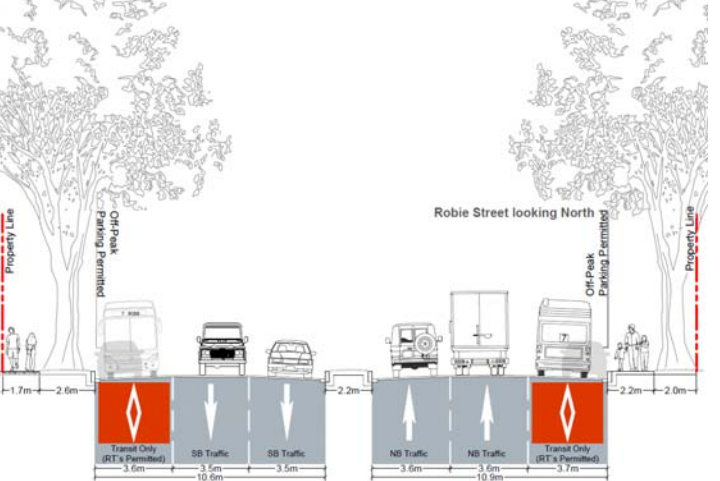
Resulting traffic congestion may encourage motorists to consider alternatives such as (i) shifting to other modes (i.e. transit, active transportation), (ii) changing commute times earlier or later in the day, and (iii) diversion to other routes. It is difficult to predict how motorists will react to the proposed changes, but it is anticipated that provision of higher order transit – the type facilitated by the changes proposed in this report – will be essential in efforts to make transit a more attractive option for more people. These are the types of behavior shifts that are fundamental to the success of the IMP’s transportation planning objectives.

Table 11: Summary of Intersection Modifications / Impacts – Robie Street Transit Priority Corridor (Phase 1)

| Intersection | Proposed Changes | Impacts |
|-------------------------------------|---|--|
| Young Street @ Kempt Road | Young Street WB Approach: reduced from two through lanes to one. | Impacts are not expected to be significant; however, there is potential that queue spillback between Kempt Road and Robie Street could impede operations during peak periods due to the limited distance between the intersections. |
| Robie Street @ Young Street | Robie Street SB Approach: reduced from two through lanes to one. Young Street WB Approach: reduced from two through lanes to one. | Impacts to affected movements (primarily Robie Street SB through and Young Street WB movements) that may significantly increase vehicle delay (up to approximately 60 seconds per vehicle) and maximum vehicle queues by up to approximately four times relative to existing peak period conditions. |
| Robie Street @ Almon Street | Robie Street NB Approach: Prohibit left turn movement to Almon Street and convert curb lane from a through-right to right-turn only (except buses). | During the PM peak hour, impacts to affected movements (primarily Robie Street NB through movement) may significantly increase vehicle delay (up to approximately 60 seconds per vehicle) and maximum vehicle queues by up to approximately three times relative to existing peak period conditions. Also, prohibition of the NB left turn movement may be inconvenient for some drivers and result in traffic diversion to other intersections. |
| Robie Street @ North Street | Robie Street NB Approach: Retain existing lane configuration but allow NB buses to proceed through from the right turn lane. | Impacts are not expected to be significant; however, there is potential that a reduction in storage space for the NB right turn movement at North Street could result in queues impeding the NB through movement. |
| Robie Street @ Cunard Street | Robie Street NB Approach: Convert curb lane to right turn only (except buses). Cunard Street: <ul style="list-style-type: none"> • Modify the east intersection leg to realign the EB movement, as illustrated in the concept presented in Figure 3. • Remove WB right turn lane | During the PM peak hour, impacts to the Robie Street NB and Cunard Street WB approaches may significantly increase vehicle delay (up to approximately 40 seconds per vehicle) and maximum vehicle queues by up to approximately two times relative to existing peak period conditions. |

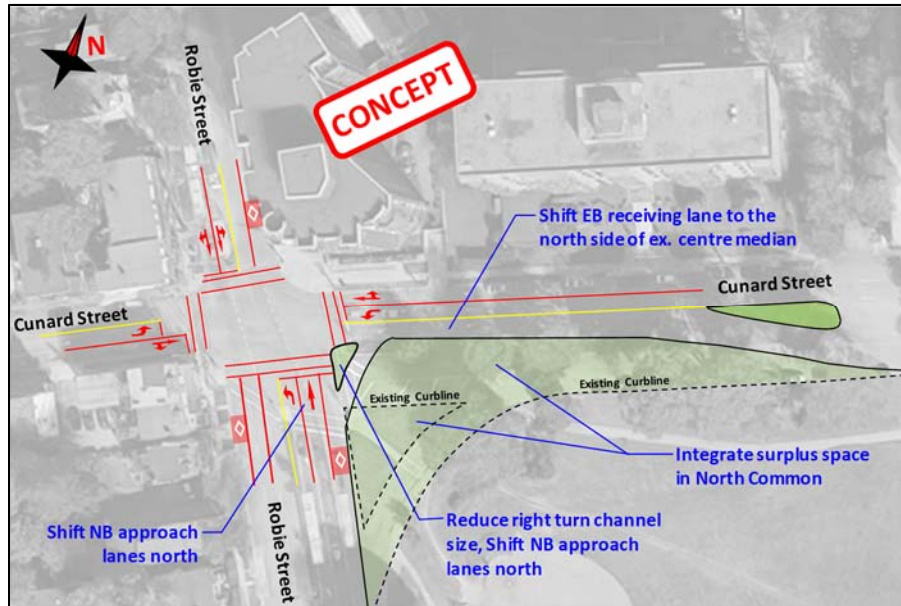

Figure 3: Proposed Intersection Configuration – Robie Street @ Cunard Street

- **Transit Service:** Significant transit improvement in both directions is expected, as buses avoid the traffic congestion that frequently occurs during peak periods. It is estimated that these transit priority measures will substantially reduce delay, particularly for peak direction buses during morning and afternoon peak periods. For example, travel time data for Robie Street indicate that total trip time between South Street and Young Street regularly increases by up to 18 minutes during the weekday PM peak. The proposed transit priority improvements will enable buses to avoid these significant delays, which will improve schedule adherence during congested periods and play an influential role in making the service more attractive to users.

With implementation of these transit priority improvements on Robie Street, it is anticipated that consideration will be given to relocating some limited stop services included in the MFTP (i.e. Routes 135, 136, 137, 138, 186, 192, 194, 196) from Gottingen Street, which runs parallel. Because of the low overall impact on ridership, these routes could be relocated to Robie Street without changing the general purpose of the routes, provided that the relocation would have a net positive impact on reliability and running time.

- **Active Transportation:**
 - **Walking:** Since roadway widening is not necessary as part of proposed Phase 1 improvements, pedestrian crossing distance will not increase. The proposed reconfiguration of the Robie Street – Cunard Street intersection has the potential to improve the pedestrian experience considerably through decreased crossing distances and reduced exposure to conflicts with vehicular traffic.
 - **Bicycling:** Bicycles will be permitted to ride in the bus lanes. However, Robie Street is not an identified cycling corridor, and parallel north-south cycling routes more suited to comfortable cycling are currently available (bicycle lanes on Windsor Street and South Park Street) or are being planned (local street bikeways on Vernon Street, Seymour Street, and other routes currently under consideration in the north end).

Parking / Loading: Impacts to approximately 57 existing on-street parking spaces on Robie Street between Quinpool Road and Almon Street. A Parking Study that includes a review of existing on-street parking and loading on Robie Street (and the immediately surrounding streets) is included in **Attachment D**. Parking utilization observations on Robie Street suggest that parking occupancy and parking duration are relatively high, with an overall average of 66% utilized and localized areas

where utilization exceeded 80%. In general, parking turnover was limited, with overall average parking duration exceeding 4 hours. It appears that there is limited potential for abutting side streets to absorb parking loss on Robie Street; it is also noted that other ongoing active transportation projects on abutting side streets could result in additional parking impacts that could further limit this potential.

There are no formally signed loading zones on Robie Street; however, the Nova Scotia Motor Vehicle Act allows stopping temporarily within a “No Parking” zone while engaged in loading or unloading. As a result, “No Parking” zones effectively operate as de facto loading areas. Current demand for loading is focused primarily around commercial properties located north of Cunard Street. A summary of existing loading activities is included in **Attachment D**.

Designating the bus lane as operational only during certain times (i.e. weekday 6AM – 6PM) would eliminate all on-street parking and loading during those peak periods but would provide the opportunity to accommodate these uses outside of peak periods, and in some areas add parking where it currently isn’t available. This may be desirable given the relatively high demand for parking along some sections of the corridor. Retaining on-street parking during off-peak periods also reduces the effective width of the traveled way, which typically has the benefit of reducing vehicle speeds. It is noted that there are challenges associated with this type of time-variable curb use – specifically, these include the need for additional and potentially confusing signage, non-compliance by users (both on purpose and because of confusion), and the need for additional enforcement resources. It is anticipated that HRM’s Curbside Management policy will encourage increased use of time-variable curb use to better accommodate curbside needs throughout the day – increased familiarity with this type of curbside management approach, in combination with public education and awareness initiatives, can help to improve public understanding and compliance. Options for time-restricted bus lanes and their associated implications for compliance and enforcement are summarized in Table 12.

Table 12: Time-Restricted Bus Lane Options

| Bus Lane Operational | | Parking / Loading Permitted | Comments |
|----------------------|-----------------------|--|--|
| 1 | Full-Time | N/A | Provides the clearest direction about how curb space can be used (allows for the use of more permanent pavement markings and simple signage). Does not allow for flexible use of curb space and may induce higher traffic speeds when bus service is limited. |
| 2 | Weekdays All Day | Weekends All Day | Minimal restrictions around curb access reduces potential confusion, but weekend parking requires that pavement markings and signage be flexible. Flexible use of curb space improves street function when transit priority is least critical. |
| 3 | Weekdays 6AM - 6PM | Weekdays 6PM – 6AM Weekends All Day | Curb access restrictions change multiple times daily, increasing signage requirements and potential for confusion and non-compliance. Flexible use of curb space improves street function when transit priority is least critical, but limits usefulness of transit lane for buses weekday evenings, when they may still have value. |
| 4 | Weekdays 6-9AM, 3-6PM | Weekdays 6PM – 6AM Weekdays 9AM – 3PM Weekends All Day | Curb access restrictions change several times daily, increasing signage requirements and potential for confusion and non-compliance. Flexible use of curb space improves street function when transit priority is least critical, but limits usefulness of transit lane for buses midday and evenings on weekdays, when they may still have value. |

COMMUNITY ENGAGEMENT

Stakeholder and public consultation were completed to develop an understanding of the key issues on each corridor and solicit feedback on the presented concept designs.

- Stakeholder consultation sessions were held with the following groups:
 - North End Business Association
 - Halifax Shopping Centre (20Vic Management)
 - Halifax Cycling Coalition
 - It's More Than Buses
 - Walk & Roll
 - Canadian National Institute for the Blind (CNIB)
 - Dalhousie Transportation Collaboratory (DalTrac)

The information obtained from these groups was considered during the development of the design options and incorporated into the options evaluation process.

- Functional design options for both corridors were presented at a public consultation session on Thursday, February 1st, 2018 at the Maritime Hall. In addition, a Shape Your City online engagement portal was established for each corridor. Feedback was collected via in-person comments, a paper feedback survey, and an online survey (there were a total of 601 respondents for the Robie Street survey, and 442 respondents for the Young Street survey). The information obtained from public consultation was used to develop an understanding of priorities on each corridor and evaluate public response to the design options. Survey results are summarized in **Attachment E**.

Summary of Stakeholder and Public Consultation Feedback:

The Robie Street and Young Street corridor concept options were presented to the public at an Open House on Thursday, February 1st, 2018, and a Shape Your City online consultation page was established. Results are provided in **Attachment E** and summarized below.

- Robie Street:
 - Total survey respondents: 601
 - The addition of curbside bus lanes in both directions on Robie Street received a favorable response from more than 70% of respondents. Support for a curbside bus lane in one direction only was much less popular, with only 35% of responses favorable (respondents were presented this as an ultimate solution as opposed to an interim solution).
 - Support for centre median bus lanes was mixed, with approximately half of respondents indicating a favorable response.
 - Among the potential trade-offs associated with implementation of the presented options (property impacts, parking / loading, traffic congestion, increased bus traffic, and implementation costs), the potential for increased traffic congestion was the lone category that most respondents (53%) indicated was unacceptable.
- Young Street:
 - Total survey respondents: 442
 - The addition of dedicated bus lanes on Young Street received a favorable response from more than 75% of respondents. Among the potential trade-offs associated with implementation of the presented options, the potential for increased traffic congestion was the lone category that most respondents (53%) indicated was unacceptable.
 - Support for a curbside bus lane in one direction only was less popular, with only 40% of responses favorable (respondents were presented this as an ultimate solution as opposed to an interim solution).

Next Steps / Implementation Plan

The following describes the next steps that are anticipated to be required for implementation of both

corridors.

Phase 1 Transit Priority Upgrades:

- Detailed Design of recommended Phase 1 upgrades on Robie Street and Young Street will be completed by staff, potentially with assistance from an engineering consultant. During detailed design, public and stakeholder engagement will be completed to provide opportunity for additional feedback on the design and related impacts.
- Implementation of the recommended Phase 1 upgrades is not anticipated to require property acquisition, which significantly reduces schedule uncertainty. Along most of the corridor, construction will be limited to modification to pavement markings and signage. Proposed upgrades at the Robie Street – Cunard Street intersection represent the most significant construction works included in Phase 1.
- If the recommendations contained in this report are adopted, an approximate implementation timeline is summarized in Table 13. It is anticipated that implementation of Phase 1 can be completed during 2020.

Table 13: Estimated Implementation Timeline - Robie Street / Young Phase 1 Transit Priority Upgrades

| Task | 2019 | | 2020 | | |
|---|--------|------|--------|--------|--------|
| | Summer | Fall | Winter | Spring | Summer |
| 1. Detailed Design ^{a b} | | | | | |
| 2. Construction Tendering ^c | | | | | |
| 3. Construction ^d | | | | | |
| Notes: | | | | | |
| a. Assumes Regional Council approval of staff recommendations in June/July 2019. | | | | | |
| b. Detailed design completed by HRM internal resources or consultant (to be determined). | | | | | |
| c. Award of construction tender subject to budget availability. | | | | | |
| d. Construction timelines for this project are uncertain. Mitigation of construction-related impacts on traffic will likely be desired due to the significance of the Robie Street corridor. It has been assumed that construction will commence during spring, coinciding with the start of the road | | | | | |

Phase 2 Transit Priority Upgrades:

- Due to the need for property acquisition and ROW widening to add continuous curbside bus lanes on both sides of Robie Street and Young Street, the timelines associated with Phase 2 upgrades on Robie Street and Young Street are uncertain. Staff are currently undertaking a review of the ROW required to implement Phase 2 upgrades and will be developing a real estate acquisition strategy.

Long-Term Strategy:

- Though centre median bus lanes were not identified as the preferred transit priority configuration for Robie Street at this time, the future potential for higher order transit (i.e. light rail) with similar space requirements warrants consideration given the corridor’s strategic central location on the peninsula. In conjunction with the review of ROW requirements and real estate acquisition strategy described above for Phase 2, staff are completing further investigation of ROW property needs for the centre median bus lanes option. These efforts will provide staff with a better understanding of the feasibility of acquiring the lands necessary to preserve the corridor.

FINANCIAL IMPLICATIONS

It is expected that the detailed design will be undertaken by internal staff resources. Should staff resources not be available, there is \$250K of budget set aside in Capital Account CM000009 – Transit

Priority Measures, for detailed design. A preliminary Class D cost estimate for construction is \$1.9 million, which includes the transit priority measures, traffic signal rehabilitation at two intersections and other potential intersection upgrades that may be identified as part of an in-service safety audit. Construction of the recommended Robie Street and Young Street Phase 1 transit priority upgrades is not budgeted at this time. Upon completion of the detailed design process, the budget will be identified for Regional Council's consideration as part of the 2020/21 Capital Budget process.

Budget Summary: CM000009-Transit Priority Measures

| | |
|---|-------------------|
| Beginning Balance | \$1,041,072 |
| Less: Estimate of detailed design (Reservation 2558) | <u>\$ 250,000</u> |
| Remaining balance | \$ 791,072 |

RISK CONSIDERATION

Risks associated with the recommendations of this report are outlined in Table 14:

Table 14: Summary of Project Risks

| Description | Risk Level | Mitigation Opportunities |
|---|-------------------|--|
| Ability to appropriately internally resource the land acquisition effort required to be successful. | Medium | Retain external consultant to augment internal resources. |
| Encroachment of new developments in corridor, in the interim. | Medium | Ongoing review of development applications to ensure that corridor ROW needs are retained. |
| Underestimation of resulting traffic congestion. | High | Ongoing implementation of sustainable transportation initiatives that promote mode shift and transportation demand management. |

ENVIRONMENTAL IMPLICATIONS

This project is supportive of the Council Priority Outcome of building Healthy, Livable communities, as it aims to make it more convenient for residents to choose sustainable transportation options for everyday transportation purposes. Transit enhancements are aimed at encouraging more people to take transit, promoting a shift to non-auto modes (targeted in the Regional Plan and IMP) and a reduction in greenhouse gas (GHG) emissions.

ALTERNATIVES

The Transportation Standing Committee may recommend to Regional Council that some or all of the recommendations not be approved or be modified. Alternatives are presented below:

1. The Committee may recommend that Regional Council direct the CAO to modify the scope of the proposed Phase 1 transit priority upgrades on Robie Street and/or Young Street. Potential options include:
 - o Extend the proposed Phase 1 transit priority upgrades to include some or all of the Robie Street segments between Inglis Street and Quinpool Road. This alternative is not recommended at this time, as it is not anticipated that the resulting transit benefits would justify impacts (loss of the centre median, on-street parking and/or traffic lanes) and the potentially significant cost implications.
 - o Reduce the proposed Phase 1 transit priority upgrades to include only certain segments of Robie Street or Young Street. This alternative is not recommended, as it does not provide the full extent of immediate, low impact transit priority benefits that can be achieved.
 - o Modify the proposed approach time restrictions for the bus lane (operational weekdays 6AM – 6PM) to include different time restriction periods (or no time restrictions at all).

This alternative is not recommended, as staff feel that the proposed approach effectively balances the need for transit priority with other demands on the street.

2. The Committee may recommend that Regional Council direct the CAO to abandon the proposed phased approach to transit priority upgrades in favor of an approach that holds off on implementation until all necessary lands are acquired to enable construction of continuous bus lanes in both directions. This alternative is not recommended, as it does not provide the full extent of immediate, low-impact transit priority benefits that can be achieved and is not consistent with the policy direction adopted by Council in the MFTP and IMP.
3. The Committee may recommend that Regional Council direct the CAO to abandon efforts to further investigate the right-of-way acquisition requirements for the Phase 2 transit priority upgrades and/or the Robie Street centre median bus lane option. This alternative is not recommended, as it does not allow staff to fully consider the potential of these options.
4. The Committee may recommend that Regional Council direct the CAO that no changes be made to the Robie Street and/or Young Street corridor. This alternative is not recommended, as it is not consistent with the policy direction included in the MFTP and IMP.

ATTACHMENTS

Attachment A: *Halifax Transit Priority Corridors: Robie Street and Young Street* (WSP, July 2018)

Attachment B: Functional Design Drawings – Robie Street and Young Street

Attachment C: Traffic Impact Analysis – Robie Street / Young Street

Attachment D: On-Street Parking Review – Robie Street

Attachment E: Community Consultation Results Summary

A copy of this report can be obtained online at halifax.ca or by contacting the Office of the Municipal Clerk at 902.490.4210.

Report Prepared by: Mike Connors, P.Eng., Transportation Engineer, Planning & Infrastructure, 902.817.0795

Report Approved by: Patricia Hughes, Manager Planning & Scheduling, Halifax Transit 902.490.6287

Report Approved by: Peter Duncan, Manager Infrastructure Planning, Planning & Development, 902.490.5449

HALIFAX REGIONAL MUNICIPALITY

HALIFAX TRANSIT PRIORITY CORRIDORS – YOUNG STREET AND ROBIE STREET

FINAL REPORT

JULY 2018



Project No. 171-09619

Attachment A

TABLE OF CONTENTS

| | | |
|------------|---|-----------|
| 1 | INTRODUCTION AND BACKGROUND..... | 1 |
| 1.1 | Transit | 1 |
| 1.2 | Study Area..... | 2 |
| 1.3 | Study Objectives..... | 2 |
| 2 | OVERVIEW OF EXISTING OPERATIONS..... | 3 |
| 2.1 | Traffic Congestion..... | 3 |
| 2.2 | Data Collection & Review | 3 |
| 2.2.1 | Topographic Survey and GIS Data | 3 |
| 2.2.2 | Traffic Volumes..... | 4 |
| 2.2.3 | Transit Data | 5 |
| 2.2.4 | Pedestrians and Bicyclists..... | 5 |
| 2.2.5 | Parking..... | 5 |
| 3 | PROJECT APPROACH / FRAMEWORK..... | 7 |
| 3.1 | Design Objectives / Considerations..... | 7 |
| 3.2 | Design Workshop..... | 7 |
| 3.2.1 | Curbside Bus Lanes..... | 8 |
| 3.2.2 | Median Bus Lanes..... | 9 |
| 3.3 | Stakeholder & Community Consultation | 10 |
| 3.3.1 | HRM Internal Stakeholders..... | 10 |
| 3.3.2 | External Stakeholder Engagement..... | 11 |
| 3.3.3 | Public Open House | 12 |
| 3.3.4 | Online Consultation | 12 |
| 3.4 | Analysis Framework | 13 |
| 3.4.1 | Vehicular Impacts (Transit and non-transit)..... | 13 |
| 3.4.2 | Multimodal Level of Service (MMLOS) | 13 |
| 3.4.3 | Parking / Loading | 14 |
| 3.4.4 | Road Safety | 15 |
| 3.4.5 | Cost Estimates..... | 15 |
| 3.4.6 | Overall Analysis..... | 15 |
| 4 | YOUNG STREET..... | 17 |
| 4.1 | Existing Conditions | 17 |
| 4.1.1 | Existing Transit..... | 17 |
| 4.1.2 | Existing Traffic..... | 18 |
| 4.1.3 | Existing Multimodal Accommodation | 18 |
| 4.1.4 | Road Safety | 18 |
| 4.1.5 | Existing Parking..... | 18 |
| 4.2 | Young Street Modification Options..... | 19 |
| 4.3 | Young Street Options Evaluation..... | 20 |
| 5 | ROBIE STREET | 23 |
| 5.1 | Existing Conditions | 23 |

| | | |
|------------|--|-----------|
| 5.1.1 | Existing Transit | 24 |
| 5.1.2 | Existing Traffic..... | 24 |
| 5.1.3 | Existing Multimodal Accommodation..... | 25 |
| 5.1.4 | Road Safety..... | 25 |
| 5.1.5 | Existing On-street Parking | 26 |
| 5.2 | Robie Street Modification Options..... | 27 |
| 5.2.1 | Young Street to Almon Street | 29 |
| 5.2.2 | Almon Street to Cunard Street..... | 31 |
| 5.2.3 | Cunard Street to Coburg Road / Spring Garden Road..... | 33 |
| 5.2.4 | Coburg Road to Inglis Street | 35 |
| 5.3 | Robie Street Options Evaluation | 37 |
| 6 | SUMMARY & RECOMMENDATIONS..... | 43 |
| 6.1 | Summary | 43 |
| 6.2 | Recommendations..... | 44 |
| 6.2.1 | Recommendations - Young Street..... | 44 |
| 6.2.2 | Recommendations - Robie Street..... | 45 |
| 6.3 | Conclusion | 45 |

APPENDICES

- A** FUNCTIONAL DESIGNS
- B** PUBLIC CONSULTATION FEEDBACK FORMS
- C** ONLINE CONSULTATION RESULTS
- D** COST ESTIMATES
- E** METHODOLOGY FOR DELAY AND PAYBACK CALCULATIONS
- F** YOUNG STREET INTERSECTION CAPACITY ANALYSIS
- G** ROBIE STREET INTERSECTION CAPACITY ANALYSIS

1 INTRODUCTION AND BACKGROUND

1.1 BACKGROUND

Recent and ongoing policy development efforts have made improvements to Halifax's transit service a key priority for the Municipality. Specifically, Halifax Transit's *Moving Forward Together Plan* (adopted by Regional Council in April 2016) includes bold moves that aim to improve transit service levels through increased priority, enhanced reliability, and reduced travel time. The bold moves are being made in support of the following four Council-endorsed 'Moving Forward Principles':

1. Increase the proportion of resources allocated towards high ridership services.
2. Build a simplified transfer based system.
3. Invest in service quality and reliability.
4. Give transit increased priority in the transportation network.



Among the key initiatives that the Municipality is considering for transit upgrades are Transit Priority Measures (TPMs) – strategically located street and intersection upgrades that provide priority for the movement of buses. TPMs provide opportunities to make notable improvements to transit operation, and can be particularly effective in locations where right-of-way (ROW) constraints limit the ability to implement more dedicated facility options. When used effectively, TPMs can provide significant network benefits to transit operation that can stem from time savings of as little as a few seconds at a time, with greater improvements when provided along a full corridor.

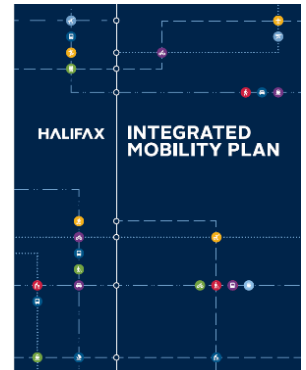

The *Integrated Mobility Plan* (IMP) was unanimously approved by Halifax Regional Council on December 5, 2017. The Plan identifies 137 specific actions to promote mobility through the municipality and encourage the use of non-auto modes. The plan identifies specific routes as Transit Priority Corridors and its Action #91 specifically recommends that the Municipality should:

IMP #91: *Prioritize the delivery of Transit Priority Corridors, starting with but not limited to:*

1. *Bayers Road (Romans Avenue to Windsor Street).*
2. *Gottingen Street (North Street to Cogswell Street).*
3. **Robie Street (Young Street to Inglis Street).**
4. **Young Street (Windsor Street to Robie Street).**

WSP Canada Inc. has been retained to prepare functional designs for transit priority on the four corridors identified in the IMP Action #91.

Analysis was completed and a recommendation report was submitted to Transportation Standing Committee (TSC) on February 1, 2018 to provide corridor level transit priority on Bayers Road and Gottingen Street. Regional Council has approved the corridor level transit priority on Bayers Road that includes some widening along the corridor and realignment of the Halifax Shopping Centre intersection to provide what is expected to be a significant improvement for transit operations along that corridor. Additionally, Halifax Regional Council has approved transit priority for Gottingen Street that is expected to provide benefit to thousands of daily transit users. That project is proceeding to detailed design with construction expected in 2018.

This current report represents Phase 2 of the project and reviews options for continuing the transit priority to **Young Street** and **Robie Street**.

1.2 STUDY AREA

The Study Area for this phase of this project includes the following corridors (shown in Figure 1-1):

1. Young Street: Windsor Street to Robie Street; and,
2. Robie Street: Young Street to Inglis Street.

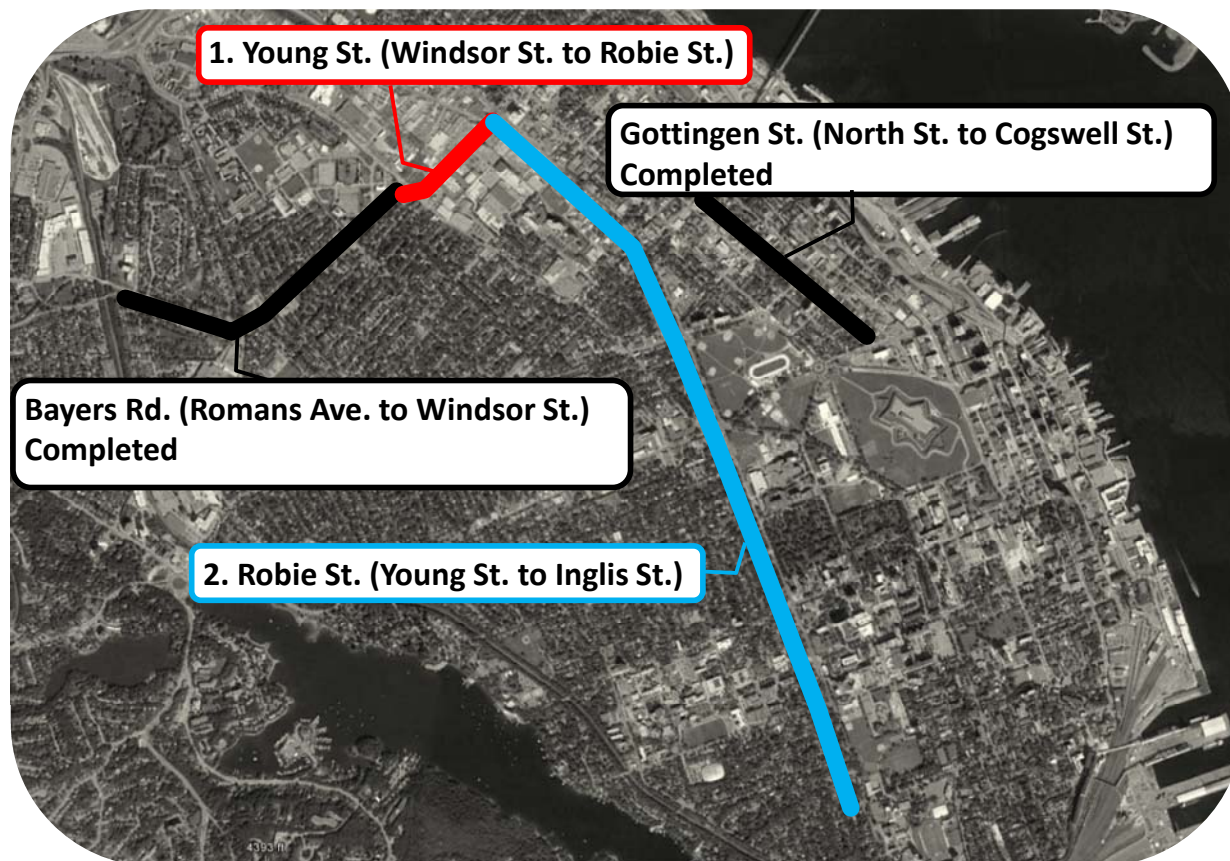

Figure 1-1 – Study Area Corridors

1.3 STUDY OBJECTIVES

The primary goal of this assignment is to develop and evaluate functional design options for transit priority along the study area corridors. Specific project objectives include:

1. Complete a detailed investigation of existing conditions within the Study Areas, including topographic survey and establishment of the functional operations of each street (i.e. traffic operation, transit delay, parking, loading, etc.);
2. Develop an understanding of existing and projected multimodal transportation demands;
3. Prepare functional design options and 'Class D' Cost Estimates for each proposed option along each transit priority corridor;
4. Engage with key HRM internal stakeholders, external stakeholders, and the general public to identify the relevant constraints and obtain feedback on design options;
5. Complete assessments for each of the functional design options that focus on transit operational benefits, intersection performance, parking / curb access, and road safety considerations;
6. Prepare a design report that documents background information, summarizes key design assumptions and rationale, and provides comparative evaluation for each option.

2 OVERVIEW OF EXISTING OPERATIONS

2.1 TRAFFIC CONGESTION

Traffic congestion along the considered corridors has become an increasing concern in recent years (See Figure 2-1 where red indicates heavy congestion with green indicating light congestion). Long delays and queues have been observed throughout the study area, particularly northbound on Robie Street during the PM peak period, where travel times for traffic between Inglis Street and Young Street have been observed to range from 15-30 minutes on a typical weekday (compared to 10-15 minutes during periods of reduced congestion).

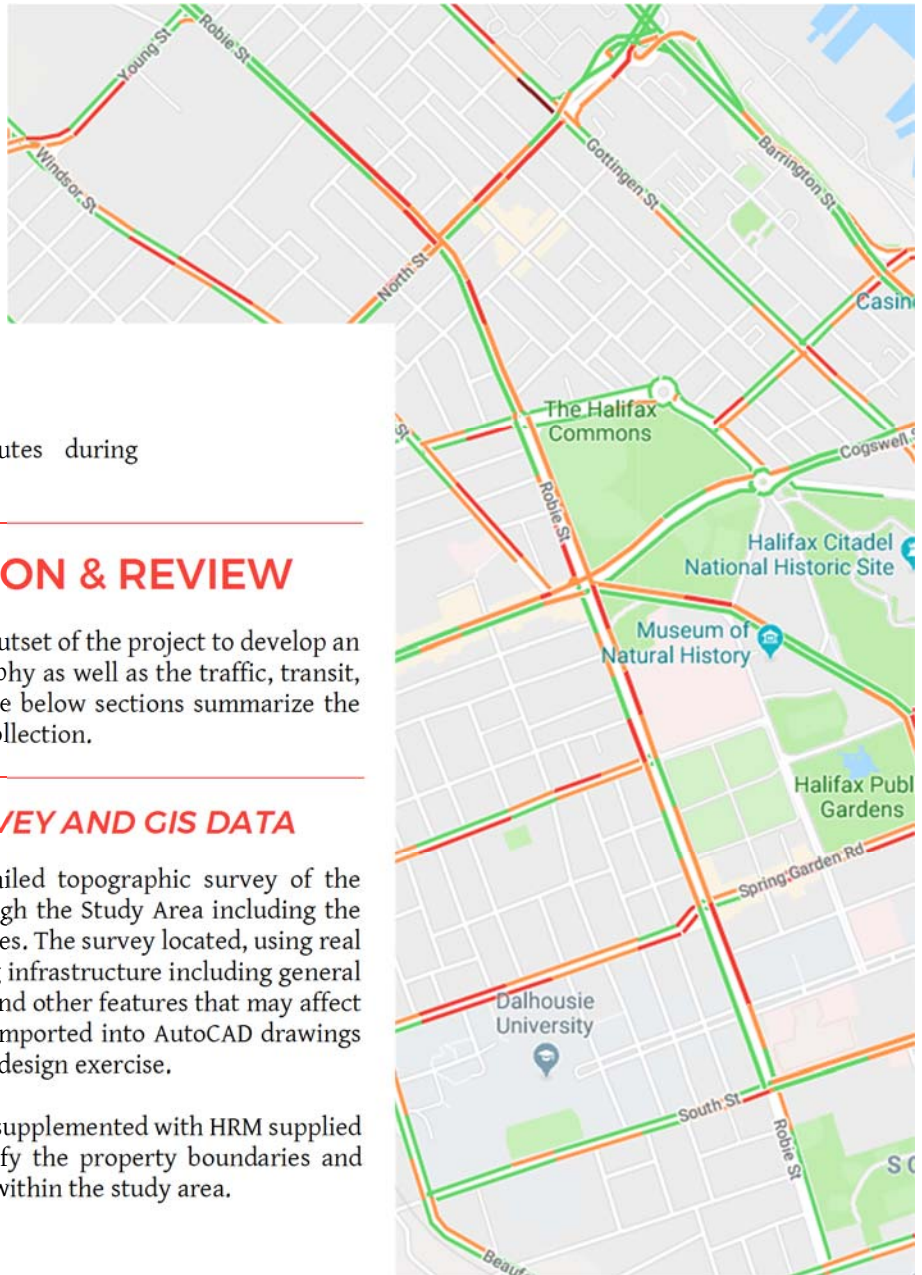

Figure 2-1 - Google Traffic Maps
4:10 PM, February 1, 2018

2.2 DATA COLLECTION & REVIEW

Significant data were collected at the outset of the project to develop an understanding of the existing topography as well as the traffic, transit, and active transportation demand. The below sections summarize the methodology and results of this data collection.

2.2.1 TOPOGRAPHIC SURVEY AND GIS DATA

WSP's survey team conducted a detailed topographic survey of the existing terrain of the corridors through the Study Area including the approach streets and abutting properties. The survey located, using real world coordinates, all relevant existing infrastructure including general site grades, curbs, utility poles, trees, and other features that may affect the proposed designs. The data were imported into AutoCAD drawings for use as the topographic base for the design exercise.

The topographic field survey has been supplemented with HRM supplied GIS data and aerial imagery to identify the property boundaries and approximate HRM right-of-way limits within the study area.

2.2.2 TRAFFIC VOLUMES

Intersection turning movement counts (collected between 2012 and 2016) and existing traffic signal timings for key study area intersections were provided by HRM Traffic Management for use in the review of existing traffic characteristics and analysis of intersection performance. Historical 24-hour machine counts were also provided along each corridor for consideration of historical and anticipated growth trends.

GROWTH TRENDS

Traffic volumes collected by HRM along each corridor were analyzed in order to develop an understanding of traffic growth trends. While results (See Figure 2-2) do not indicate a clear growth trend for traffic volumes on study area routes, they do indicate substantial variability in corridor traffic volumes.

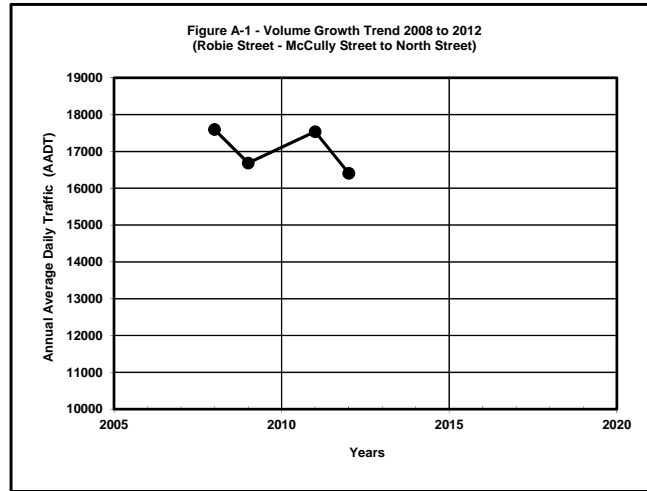
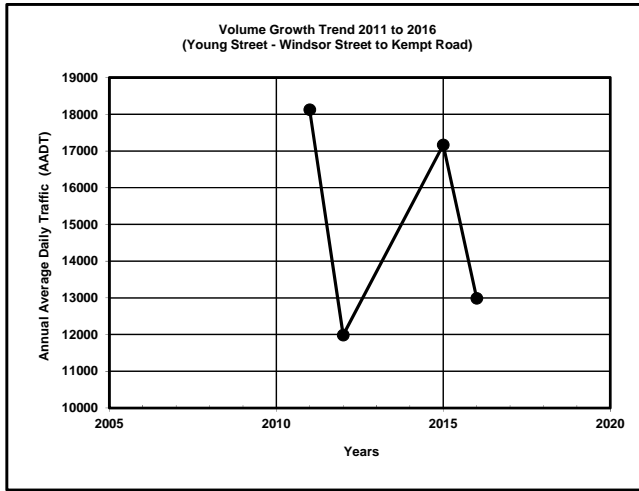

Figure 2-2 - Traffic Volume Growth Rates - Young Street and Robie Street

DESIGN HOURLY VOLUMES

Design hourly volumes were developed using the intersection turning movement count data collected by HRM Traffic Management with an added 5% design hourly factor. This factor is not intended to consider any traffic volume growth resulting from proposed or anticipated development in this area but considers the day-to-day variability in traffic volumes.

Given the volume variability and lack of a clear historical trend of annual volume growth, the design hourly volumes have been estimated using the observed AM and PM peak hour volumes with a 5% design hourly factor but no additional annual growth. If traffic volume growth is observed in the future, it is expected to increase congestion and increase the need for transit priority.

2.2.3 TRANSIT DATA

Since there is some uncertainty of planned frequency for some of the future routes identified in *Moving Forward Together Plan* (Halifax Transit, 2016) and because ridership forecasts for these routes were not available for this project, transit vehicle and ridership volumes for existing routing (provided by Halifax Transit) were used in the analysis.

It is recognized that each of the study area roads have been identified as Transit Priority Corridors by the Council approved *Integrated Mobility Plan*. While analysis uses existing vehicle and ridership volumes, it is expected that transit ridership and vehicle volumes will likely increase, particularly with the implementation of corridor level transit priority measures.

2.2.4 PEDESTRIANS AND BICYCLISTS

Available pedestrian and bicycle volume data for the study area were provided by HRM Traffic Management. These included counts of bicyclists at the Robie Street at Bell Road intersection as well as screenline counts for several streets in the area. Counts were collected twice per year (Spring and Fall) from 2013 to 2016.

2.2.5 PARKING

Field investigation was completed by WSP to inventory the location of existing on-street parking along each of the studied corridors. Data on parking utilization were not available.

Attachment A

This Space Intentionally Left Blank

3 PROJECT APPROACH / FRAMEWORK

3.1 DESIGN OBJECTIVES / CONSIDERATIONS

The design objective for this project is to provide priority for transit along each corridor while also considering active transportation, traffic operations (including heavy vehicles) as well as the impact to parking and adjacent properties. The considerations are summarized in Table 3-1.

Table 3-1 - Project Considerations

| Factor | Evaluation Considerations |
|--|---|
| Halifax Transit | Efficient movement of buses through the study corridors is a key consideration of this project. Design options have reviewed the ability of buses to navigate through the intersections and along the corridors with consideration given to the estimated and observed delays under existing conditions and the potential to improve transit operation through transit priority. |
| Active Transportation (Pedestrians / Cyclists) | Accommodation of active transportation is very important to HRM and the provision of sidewalks and safe street crossings is an important consideration. Evaluation of each design options based on pedestrian and cyclist accommodation will focus on the extent to which key inputs such as pedestrian / cyclist exposure to vehicular traffic (i.e. crossing distances) are expected to change with implementation of each option. |
| Vehicular Traffic | Both Young Street and Robie Street in the project study area are classified as arterial streets and designated as Truck Routes by HRM By-Law T-400. The approach of the assessment of impacts to vehicular traffic includes performance analysis of the intersections and the corridors under consideration. Intersection performance analysis, completed using Synchro / SimTraffic is the basis upon which intersection capacity requirements (i.e. lane configurations, # of lanes) are determined. Comparison of results among the design alternatives enables understanding of the impact that each has on vehicular traffic performance. |
| Parking / Loading | The available parking and loading has been identified along the study area corridors. Impacts to parking and loading have been considered in the analysis. |
| Right-of-Way Impacts | Consideration has been given to the impacts of roadway expansion. Where available, properties already owned by HRM were considered first and where necessary, property acquisition has been identified. Other impacts on adjacent properties (i.e. grading) were also considered in the options analysis. |

3.2 DESIGN WORKSHOP

A Functional Design Workshop was held early in the design phase (August 16, 2017) with HRM staff to discuss innovative, yet feasible options for transit priority measures along each corridor. A discussion on prioritization within a transit priority corridor began the workshop. Although it was recognized that precise priorities for each corridor and section of each corridor is highly context sensitive, the group came to a consensus that right-of-way prioritization for the transit corridors were:

- | | |
|-----------------|-----------------------------------|
| Higher Priority | 1. Sidewalk |
| ↓ | 2. Transit and transit stops |
| | 3. Non-Transit Traffic |
| | 4. Deliveries and Loading |
| | 5. Parking (Vehicular / Bicycles) |
| | Lower Priority |

During the design workshop, different types of transit lanes were discussed as options for consideration on this project. These lane types are described in the following sections.

3.2.1 CURBSIDE BUS LANES

Curbside bus lanes provide a dedicated lane for buses, allowing them to avoid traffic congestion. This reduces the delay experienced by buses and increases the overall reliability of the transit network. The curbside lane is intended for use only by transit vehicles, however general traffic may also use the lane strictly for making right turn movements. Where no receiving lane is available, Transit Signal Priority (TSP) can also be provided to buses as they are able to bypass long queues of traffic in their dedicated travel lane. Curbside bus lanes should be designated with diamond pavement markings, and in some cases red markings to improve visibility.



Dedicated curbside bus lane, right-turns permitted for general traffic

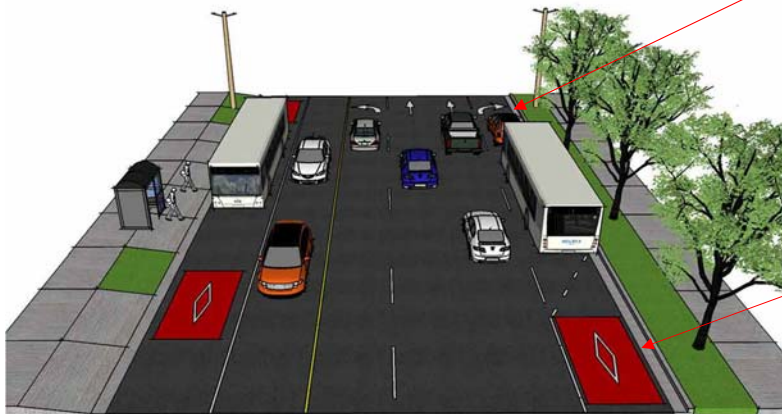

Diamond pavement markings are commonly used to identify curbside bus lanes



WHERE ARE THEY SUITABLE?

Curbside bus lanes are best suited on high volume corridors with heavy congestion, frequent transit service, and a low volume of right turn movements and parking.

| | |
|---|---|
| Transit Operational Improvements | Curbside bus lanes give transit their own dedicated lane allowing them to bypass traffic congestion, increasing their overall reliability. |
| Road Safety | Curbside bus lanes reduce the number of potential conflicts between buses and general traffic including parked cars and roadway projects have indicated a reduction in total collisions with the installation of curbside transit lanes (Source: http://www.wrirosscities.org/sites/default/files/Traffic-Safety-Bus-Priority-Corridors-BRT-EMBARQ-World-Resources-Institute.pdf). |
| Trade-Offs | Curbside bus lanes can be installed by either (i) repurposing curbside space (traffic lanes / parking) or (ii) street widening. This leads to reduced traffic capacity, loss of on-street parking / loading loss, and / or property impacts. |
| Public Realm | Curbside bus lanes may result in lower volume but higher speed vehicles in the curb lane abutting the sidewalk if insufficient boulevard space is provided between the bus lane and the sidewalk. |

3.2.2 MEDIAN BUS LANES

Median bus lanes also provide a dedicated lane for buses, allowing them to avoid traffic congestion. This reduces the delay experienced by buses and increases the overall reliability of the transit network. The median lane is typically intended for use only by transit vehicles. Median bus lanes can be designated with diamond pavement markings, and in some cases red paint to improve visibility.

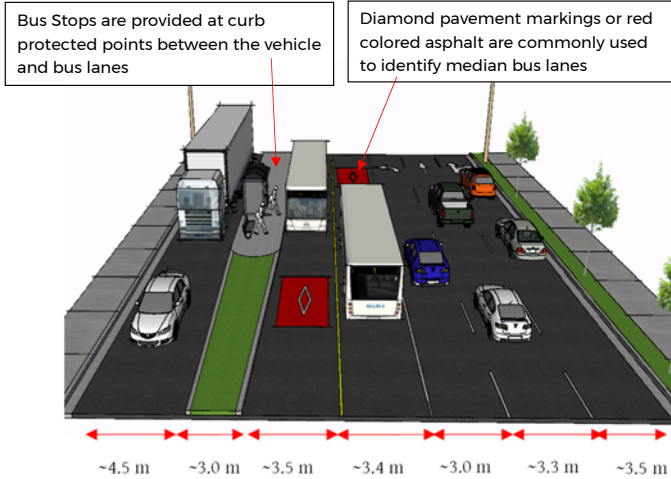

Median Transit Lanes
(Highway 7, Richmond Hill, Ontario)

WHERE ARE THEY SUITABLE?

Median bus lanes are best suited on high volume corridors with heavy congestion, frequent transit service, and low left turning volume. Due to conflicting movements, left turn vehicles require signal separation from the through bus movements. Where these left turn volumes are high, this signal phase can be lengthy, potentially leading to increased delay. They also require a wider right-of-way due to the required pedestrian refuges / median bus stops.

| | |
|---|---|
| Transit Operational Improvements | Median bus lanes give transit their own dedicated lane allowing them to bypass traffic congestion, increasing their overall reliability. The transit lane is not shared with mixed traffic or parking, providing potential improvements compared to curbside lanes. |
| Road Safety | Collision data for several projects in Canada (Vancouver Blue Line and Spadina Avenue) indicate that median lanes offer some safety benefits due to reduced conflict points with separation of transit and non-transit vehicles, however, safety concerns were also identified including: <ul style="list-style-type: none"> • Potential conflicts with simultaneous left turning vehicles. • Pedestrians are required to cross traffic lanes to reach the bus stop. • Wider intersections require longer pedestrian crossings and clearance intervals. • Potential increase in collisions shortly after implementation due to drivers being unfamiliar with the lane type. |
| Trade-Offs | Median bus lanes can be installed by either (i) repurposing existing space (traffic lanes / parking) or (ii) street widening. This leads to reduced traffic capacity, loss of on-street parking / loading loss, and / or property impacts. Median transit lanes generally require more space than curbside lanes due to the need for transit platforms and additional curb offsets. Median lanes have a greater potential impact to traffic flow by eliminating left turns except at signalized intersections. |
| Public Realm | Median bus lanes generally require more space than curbside bus lanes, which can lead to longer pedestrian crossing distances. Median bus lanes require that the bus stops are also located on a refuge island, increasing the required number of crossings per transit user. Transit users are also required to wait for the bus on the refuge island, which can make some transit users uncomfortable if insufficient space is provided. |

3.3 STAKEHOLDER & COMMUNITY CONSULTATION

One of the key aspects of this project was the consultation with stakeholders and the public at large. Separate meetings were held with HRM staff, stakeholder groups external to the municipality, and with the public through Open House style meetings and via an online survey.

3.3.1 HRM INTERNAL STAKEHOLDERS

A meeting was held with HRM Internal staff (July 27, 2017) who provided insight to various areas of expertise related to TPM on the identified corridors. Attendees represented the following areas of interest and expertise:

- Strategic Transportation Planning
- Traffic Management
- Parking Management
- Halifax Transit
- Streetscaping and Active Transportation
- Planning and Development
- Urban Forestry
- Cogswell Redevelopment Project

The following is a summary of what we heard from HRM staff:

YOUNG STREET

- Young Street provides access to large commercial properties.
- Centre Plan: This area is designated as a growth centre. It is envisioned as being high density.
 - Sidewalks and streetscaping need to be better and more conducive to the pedestrian.
 - For all new development in the area, HRM is particularly interested in setbacks.
 - This whole area (north of Almon St.) is envisioned as being re-created into a new “Super Block” area. There is a need to reconnect the area with smaller block systems for increased access and movement for all modes of travel.
- Bus operators request having a left turn signal from Robie St. to Young St. more than any other spot in the city.
- A very important consideration on Young Street will be access management into the large commercial and higher density residential properties.
- Large development on the northeast corner of Young St./ Windsor St./ and Bayers Rd. has been approved.
- Access management will be really important to consider along this corridor. Centre Plan’s land use by-law will have the ability to regulate property access. The regulations for Young Street will be released in February 2018, and hopefully approved by September 2018.
- There are no plans for cycling projects along Young Street. Cycling work will be focused more on off-street than this corridor.

ROBIE STREET

- Centre Plan has Robie Street designated as a corridor from Young Street to Spring Garden Road.
- There is a separate study currently being done for Bus Rapid Transit within the municipality. Robie could very well be considered as a BRT corridor.
- Currently there is a queue jumping lane (southbound) at Almon St. and Robie St. – however there is not a receiving lane on the other side.
- The challenging parts of this roadway will be between Cunard St. and Almon St. Road widening will be challenging in this section.
- Significant tree interest located between North Street and Cunard Street.
- Possible road widening opportunity in front of the O’Regan’s dealership. It appears the property line is set back further into the parking lot.
- Throughout the corridor, there are a number of development opportunities with active applications in to HRM now. If additional setback is needed to accommodate bus lanes, discussions with developers need to be made now.
- Halifax Common lands are undergoing a master planning exercise. If road widening occurs, impacts to Common land should be considered.
- Impacts to parking need to also be considered, specifically around the universities/hospitals?
- Try to minimize asphalt as much as possible along the corridor.

3.3.2 EXTERNAL STAKEHOLDER ENGAGEMENT

Separate meetings with stakeholders external to municipal staff were also held to introduce and review the project. Project information and consultation meetings were held with the Halifax Utility Coordinating Committee (HUCC, July 13, 2017), and various community advocacy groups. The following is a summary of feedback provided from each of the external stakeholder meetings.

HALIFAX UTILITY COORDINATING COMMITTEE (HUCC)

- Prior to any construction, HUCC members will need to know whether or not utility relocation is required.
- A change in curbs will be their biggest concern. These will have impacts of where their services are located.
- Relocation of utilities will be costly.
- Will federal infrastructure money help pay for the costs to relocate utilities?

COMMUNITY ADVOCACY GROUPS

Members from community advocacy groups came together for a project introduction and consultation meeting. The following groups were represented at this meeting:

- Walk n Roll
- Halifax Cycling Coalition
- DalTrac
- It's More than Buses
- Canadian National Institute for the Blind (CNIB)

The following is a summary of what was heard:

GENERAL COMMENTS

- General concerns were voiced from community group representatives on noise and pollution impacts, turning corridors in to “bus highways” as well as concerns on the impacts of removing on-street parking.
- Consider using TPM treatments to “brand” transit priority. (i.e. consider colouring the pavement for the bus only lanes.)
- TPM projects cannot put pedestrians at a disadvantage. Designs will require careful consideration to streetscaping, pedestrian crossing distances, and creating safe and comfortable areas for pedestrians to travel on.
- HRM must consider accessibility planning. For the visually impaired, it is much easier to delineate the sidewalk and roadway when there is landscaping/grass between the curb and the walking area. Audible bus stops are also recommended to accommodate the visually impaired.
- How will TPM impact cyclists? Need to make sure these measures are not to their detriment.
- Community Group representatives suggested HRM should consider congestion pricing – tax personal motor vehicles going into the peninsula. This will be easier (and less money) than doing road widening and will likely see an increase in ridership numbers.
- Need to consider the impact that TPM will have on surrounding residential streets.

3.3.3 PUBLIC OPEN HOUSE

An open house (February 1, 2018) was held for members of the public to review the proposed functional design options along Young Street and Robie Street. Using panel displays, attendees were shown design options for segments of the corridor ranging from high investment (and highest impact), medium investment, and low investment (and lowest impact). A summary of user impacts were provided as well as an overview of pros and cons for various considerations of the options was

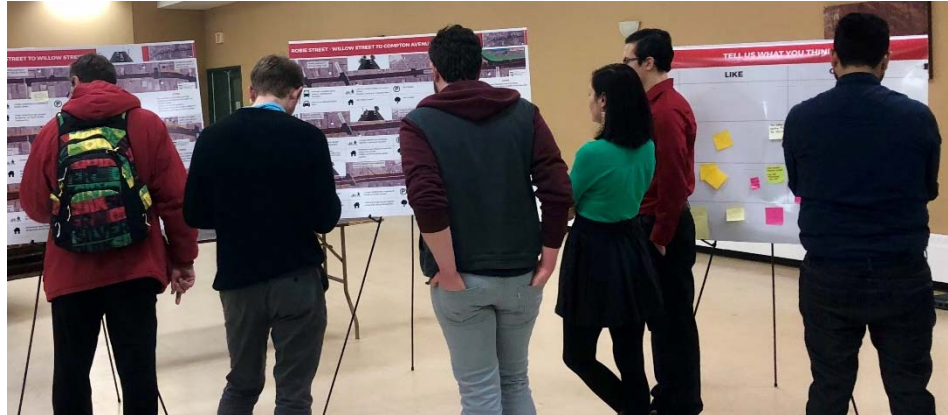

Photo 1 - Young Street / Robie Street Open House - February 1, 2018

provided to help compare impacts. Residents were asked to provide their feedback and indicate which of the design options they prefer (if any at all). Copies of the public open house boards for both Young Street and Robie Street are included in Appendix A while comment feedback results for each are presented in Appendix B.

3.3.4 ONLINE CONSULTATION

An online survey was commissioned by the HRM project team to gather further public input on the display boards (Appendix A) and made available on the project's Shape Your City website. The following are key highlights from the online survey for Young Street and Robie Street and are based on a summary report provided by HRM staff (Appendix C).

YOUNG STREET n=447

- 20% of survey participants indicated they 'Often' travel the corridor as a pedestrian.
- Nearly half of participants indicated they 'Never' travel on Young Street as a cyclist, and nearly half indicated they travel on Young Street 'Often' as a driver or passenger of a personal motor vehicle.
- Three quarters of participants indicated they do travel on Young Street as a transit user, however frequency of these responses varied from "Infrequently" (26%), to 'Occasionally' (26%), to 'Often' (17%). Additionally, 28% of respondents indicated they 'Never' travel the corridor as a transit user.
- 'Pedestrian safety and comfort' was the most commonly selected priority by respondents for level of importance on Young Street. Bus schedule reliability was the second most commonly selected priority and motor vehicle congestion and delay was the third most commonly selected.
- Road widening and impacts to properties was the most acceptable trade-off with the addition of a transit-only lane, while an increase in delay (time) for motor vehicle traffic was the least acceptable.
- The most preferred design option was the curbside transit only lanes in both directions while the least preferred option was the Curbside transit only lane, outbound only.

ROBIE STREET n=609

- One third of survey participants indicated they 'Often' travel the corridor as a pedestrian.
- Nearly half of participants indicated they 'Never' travel on Robie Street as a cyclist, and over half indicated they travel on Robie Street 'Often' as a driver or passenger of a personal motor vehicle.
- Three quarters of participants indicated they do travel on Robie Street as a transit user, however frequency of these responses varied from "Infrequently" (21%), to 'Occasionally' (28%), to 'Often' (27%). 15% of respondents indicated they 'Never' travel the corridor as a transit user.
- 'Pedestrian safety and comfort' was the most commonly selected priority by respondents for level of importance on Robie Street. Bus schedule reliability was the second most commonly selected priority and motor vehicle congestion and delay was the third most commonly selected.

- Loss of on-street parking and loading spaces was the most acceptable trade-off with the addition of a transit-only lane, while an increase in delay (time) for motor vehicle traffic was the least acceptable.
- For all corridor segments, the most preferred design option was the curbside transit only lanes in both directions. The least preferred option was the Curbside transit lane, outbound only.

3.4 ANALYSIS FRAMEWORK

The analysis of each option includes consideration of impacts on Transit Operations, Multimodal Level of Service, Traffic, Parking/Loading, and Property Impacts. The analysis framework for each of these considerations is described in the subsequent sections.

3.4.1 VEHICULAR IMPACTS (TRANSIT AND NON-TRANSIT)

In *Halifax Transit Priority Measures Study* (WSP, 2016) an analysis framework was developed to consider the costs and benefits to transit and the overall public of a given transit priority measure. That methodology has since been included as Appendix E in *Moving Forward Together Plan* (Halifax Transit, 2016) as the methodology used for the evaluation of transit priority measures. This methodology follows the following five steps:

1. **Develop estimates for the Capital Cost** using preliminary cost estimates based on functional designs.
2. **Develop estimates for annual operating cost** using approximate costs for similar measures.
3. **Develop operational cost savings to Halifax Transit** using estimates in delay reductions to transit vehicles. This can be obtained from field observation or traffic modeling and a combination of both have been used for this project.
4. **Understand the TPM's Impact to All Road Users** using estimates in changes in delay to the movement of people using the particular intersection or corridor. This includes changes in delay to transit users as well as any estimated change in delay to motorists, cyclists, or pedestrians.
5. **Determine the payback period for the Measure** using the results of the previous four steps.



To estimate the impact on transit flow that could be expected with each option along each corridor, the delay reductions to the average transit vehicle have been estimated using traffic analysis (Synchro 9 and SimTraffic) and supplemented with field observation. This analysis has been carried into the cost analysis, overall evaluation, and the methodology to calculate the delay and payback period are included in.

3.4.2 MULTIMODAL LEVEL OF SERVICE (MMLOS)

Multimodal level of service (MMLOS) is an evaluation framework that takes a more holistic approach to intersection performance analysis than the typical vehicle-focused models that are commonplace. The framework for MMLOS is based on *NCHRP Report 616* (National Cooperative Highway Research Program NCHRP, Washington, 2008), a publication that summarizes the results of a 2-year investigation of how users perceive the multimodal quality of service on urban streets. LOS models were calibrated that rate the level of comfort and delay felt by pedestrian, bicycle, and transit users at an intersection and along a corridor and enable the analysis of “tradeoffs” of various allocations of the urban street cross section among auto, pedestrian, bicycle, and transit users. The intent is to provide a more complete representation of how key variables impact the accommodation of different road users.

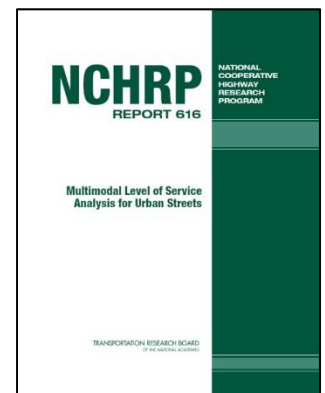

Attachment A

The NCHRP framework for MMLOS has been applied to evaluate design alternatives for the study area. The following summarizes the NCHRP framework and how it was applied to this project:

- NCHRP 616 included MMLOS models for corridors and signalized intersections only.
- Although there are transit multimodal level of service models for corridors, the factors for transit LOS consider transit scheduling and transit amenities (benches, shelters) that are outside the scope of this project. Evaluation of transit performance along each corridor has been performed separately.
- *Highway Capacity Manual 2010* (HCM 2010, National Academy of Sciences, Washington, 2010) used the research and models included in NCHRP 616 to provide MMLOS models for intersections and segments in HCM 2010. New to HCM 2010 was the MMLOS criteria for pedestrians at Two-way STOP controlled intersections (TWSC); however, HCM 2010 does not provide bicycle MMLOS at TWSC. Table 3-2 summarizes the factors that were found to influence the level of service of pedestrians and bicyclists.

Table 3-2 - Factors that influence Intersection Multimodal LOS by Active Mode (HCM 2010)

| | | Pedestrian LOS | Bicyclist LOS |
|--|--------------------|--|--|
| Signalized Intersection MMLOS | Negative Influence | <ul style="list-style-type: none"> • Volume of right turns on red • Volume of permitted left turns • Traffic in outside lane • Traffic speed • Number of lanes • Pedestrian delay • Right-turn channelized lanes (low traffic volume locations) | <ul style="list-style-type: none"> • Width of cross street • Volume of traffic |
| | Positive Influence | <ul style="list-style-type: none"> • Right-turn channelized lanes (high traffic volume locations) | <ul style="list-style-type: none"> • Width of outside through lane (and bicycle lane) • Number of lanes on approach direction |
| Two-Way STOP-Controlled Intersection MMLOS | Negative Influence | <ul style="list-style-type: none"> • Vehicle volume • Crosswalk length • Number of lanes | No model provided |
| | Positive Influence | <ul style="list-style-type: none"> • Crosswalk width • Driver yield rates | |
| Overall Segment | Negative Influence | <ul style="list-style-type: none"> • Traffic volume per lane • Vehicle travel speed • Poor intersection MMLOS | <ul style="list-style-type: none"> • Signalized Intersections • Traffic volume per lane • Vehicle travel speed • Heavy vehicle volume • Poor intersection MMLOS |
| | Positive Influence | <ul style="list-style-type: none"> • Width of outside through lane (and bicycle lane) • Parking occupancy • Presence of sidewalk buffer • Sidewalk width | <ul style="list-style-type: none"> • Width of outside through lane (and bicycle lane) |

The factors that influence MMLOS (signal timings, traffic volume, number of lanes, conflict points) have been considered when evaluating the design options for this project.

3.4.3 PARKING / LOADING

WSP has conducted a field review to quantify the available parking / loading along each corridor and consider the impact to parking and loading with each option.

3.4.4 ROAD SAFETY

WSP has considered how the options that could be expected to impact road safety through changes to the number and type of conflict points and expected travel speeds. Specific consideration was given to the alignment at major intersections and opportunities where intersection realignment or addition of left turn lanes may be expected to offer safety benefits.

3.4.5 COST ESTIMATES

Order of magnitude construction costs for each of the modification options for Robie Street and Young Street are presented in Appendix D based on the functional designs included in Appendix A. These cost estimates are limited by the current level of design detail and the available information on geotechnical conditions and underground servicing. As a result, the estimates are provided for preliminary planning purposes only with a 30% contingency included to reflect the uncertain nature of the estimates.

The construction cost estimates do not include:
 Property Acquisition; Utility Pole Relocation; Engineering, Administration and Inspection Fees. Asphalt cold planing and resurfacing costs are also not included (as it is not known if or how much resurfacing will be done in conjunction with the transit priority measure upgrades).

The Young Street estimates include an allowance for modifications to private property parking areas impacted by road widening, however Robie Street estimates do not include any demolition, reinstatement or construction on private property since many properties will need to be redeveloped in conjunction with the right-of-way widenings. Construction phasing for the project may increase costs for items like mobilization & demobilization, traffic control, and construction of temporary infrastructure between phases.

3.4.6 OVERALL ANALYSIS

Using consideration of the above factors and results from the public and stakeholder consultation, overall evaluation matrices were developed for each corridor to display the overall assessment of each option and enable comparison between categories (identified in Table 3-3). For simplicity, the matrices have been formatted to a colour scale from green (most favorable) to red (least favorable), with yellow the intermediate shade. Grey was used to indicate criteria that were not applicable or where information was not available. It should be recognized that since this evaluation does not apply weighting factors to the various evaluation criteria, it essentially assigns equal value to each criterion. This is obviously not the case in reality, as transit schedule adherence may be a more influential factor on these identified transit corridors than traffic impacts. As presented, the evaluation matrix is a visual tool that enables high level options comparison.

Each option for the full corridor has also been evaluated using the payback period analysis methodology included in *Moving Forward Together Plan* (Halifax Transit, 2016) with the methodology shown in Appendix E.

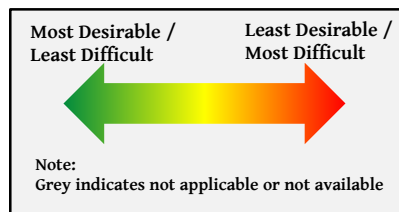

Table 3-3 - Considered Categories for Analysis

| |
|------------------------------------|
| |
| Transit Travel Time |
| Walking |
| Bicycling |
| Traffic and Heavy Vehicle Flow |
| Road Safety |
| Green space / Urban Forest |
| Onstreet Parking / Loading Impacts |
| Property Requirements |
| Implementation Cost |
| Public Feedback Response |

Attachment A

This Space Intentionally Left Blank

4 YOUNG STREET

4.1 EXISTING CONDITIONS

Young Street between Windsor Street and Robie Street (approximately 500 m) is an arterial roadway and designated truck route. Traffic volumes obtained by HRM Traffic Management indicate Annual Average Weekday Traffic (AAWT) volumes of approximately 15,000 vehicles per day (vpd).

Along the Young Street corridor, the intersections of Windsor Street, Kempt Road, and Robie Street are signalized. The intersection at Monaghan Drive is currently unsignalized and there are several full access commercial driveways along the corridor. The roadway has a four lane cross section for most of the corridor (See Figure 4-1) and widens to five lanes between Kempt Road and Robie Street (See Figure 4-2).

Congestion along this corridor has been observed primarily where vehicles turn left at driveways along the corridor and due to the closely spaced intersections at Robie Street and Kempt Road (approximately 60 m).

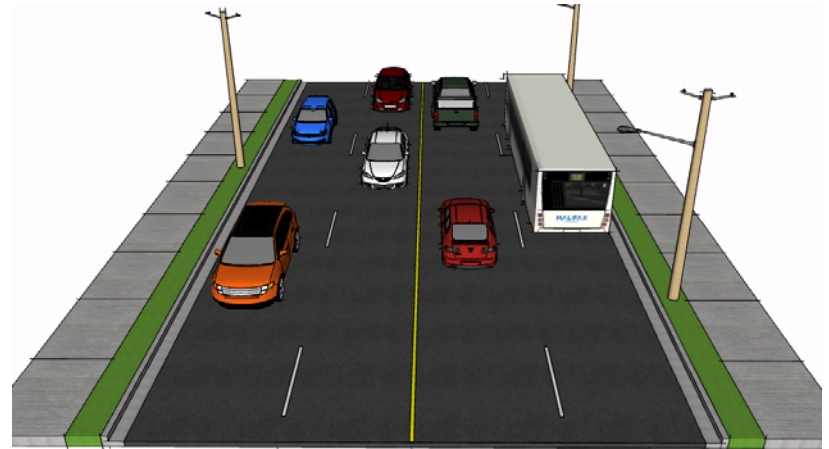

Figure 4-1 – Young Street Cross Section (Windsor to Kempt, looking West)

4.1.1 EXISTING TRANSIT

Young Street is a busy transit corridor for Halifax Transit, particularly during the AM peak period. Between Kempt Road and Robie Street it is currently used by 10 Halifax Transit Routes (#21, 31, 33, 34, 35, 42, 80, 81, 86, and 330). Transit vehicle volumes and ridership data were collected by Halifax Transit and are summarized in Table 4-1.

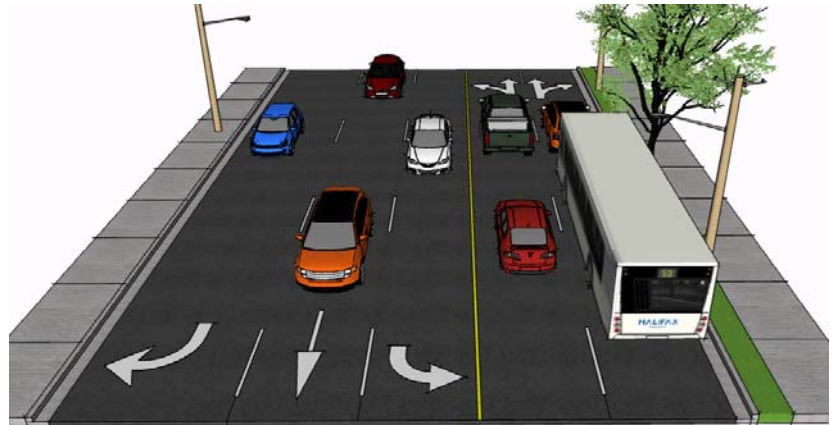

Figure 4-2 – Young Street Cross Section (Kempt to Robie, looking West)

Table 4-1 - Existing Transit Volumes and Ridership on Young Street

| | | Windsor to Kempt | | Kempt to Robie | |
|--------------|-----------|------------------|----------------|------------------|----------------|
| | | Transit Vehicles | Transit Riders | Transit Vehicles | Transit Riders |
| AM Peak Hour | Eastbound | 6 | 200 | 25 | 815 |
| | Westbound | 6 | 100 | 5 | 80 |
| PM Peak Hour | Eastbound | 4 | 60 | 9 | 110 |
| | Westbound | 13 | 340 | 16 | 455 |

4.1.2 EXISTING TRAFFIC

Turning movement counts at the Young Street intersections with Windsor Street, Kempt Road, and Robie were collected by HRM Traffic Management for the morning (7-9 AM) and afternoon (4-6 PM) peak periods. Observed AM and PM peak hour volumes are summarized in Figure 4-3. Traffic analysis of design hourly volumes (with a 5% design hourly factor), prepared using *Synchro 9* and *SimTraffic*, are summarized in Appendix F.

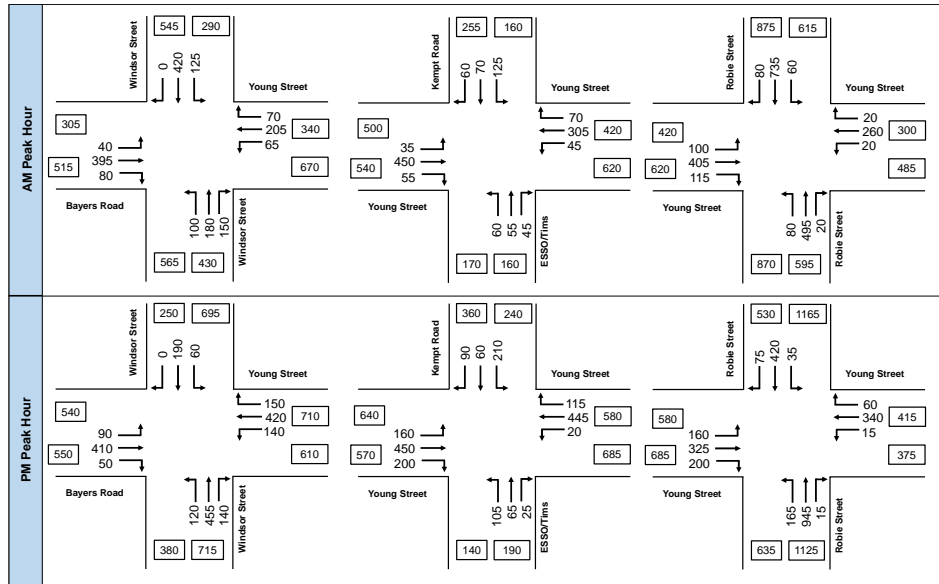

Figure 4-3 – Young St Corridor AM and PM observed peak hour traffic volumes

4.1.3 EXISTING MULTIMODAL ACCOMMODATION

A summary of the considerations that impact the multimodal aspects along this corridor are presented in Table 4-2.

Table 4-2 – Young Street - Existing MMLOS Accommodation Summary

| Mode | Evaluation Considerations |
|--------------------------|---|
| Pedestrians | There is sidewalk along both sides of this corridor and pedestrian crossings of Young Street (4 lanes wide) along this corridor are at signalized intersections or the RA-5 with flashing beacons at Monastery Lane. |
| Cyclists | No bicycle facilities are present along this corridor. North-south bicycle lanes are in place on Windsor Street. |
| Halifax Transit | No special Transit lanes exist along this corridor. Transit vehicles stop at in-lane transit stops (ie no bus bays). |
| Heavy Trucks | HRM By-law T-400 (Truck Route By-law) designates Young Street as a full-time truck route. There is a right turn channelized lane for turns from Young Street to Robie Street that accommodates all vehicles. |
| Vehicular Traffic | The majority of this corridor is marked as a four-lane cross section with no auxiliary lanes (exceptions for turns at the signalized intersections). No left turn lanes are present for turns into the driveways. Traffic queuing has been observed between the closely spaced intersections. |

4.1.4 ROAD SAFETY



Collision reports were not available for this corridor for collision analysis. A comparative analysis between the options for this corridor considered how each option changed the number or type of conflict points.

4.1.5 EXISTING PARKING

On-street Parking is currently prohibited along the entire Young Street corridor between Windsor Street and Robie Street.

4.2 YOUNG STREET MODIFICATION OPTIONS

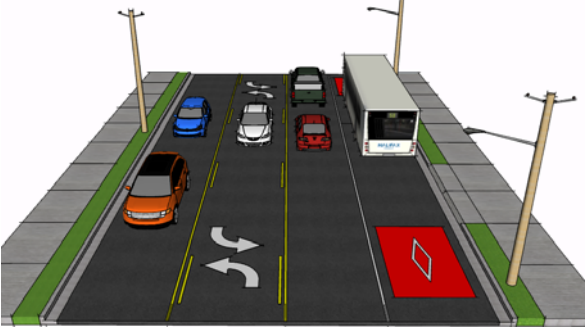
Three modification options were prepared for the Young Street corridor and are summarized below. Functional design plans for each option are included in Appendix A and cost estimates are included in Appendix D.

| Option | | Description |
|-------------------|---|---|
| Low Investment | <p>Option Y1 – Continuous outbound Transit Lane</p>  <p>*Proposed cross section looking west</p> | <ul style="list-style-type: none"> • Provide a continuous outbound transit lane; and, • Install lane for left turning vehicles for driveways and intersections. <p><u>Impacts:</u></p> <ul style="list-style-type: none"> • Provides outbound transit priority between Robie Street and Windsor Street. • Improved flow of traffic along the corridor is expected during peak periods. • Positive for safety with left turn lane. • Analysis (Appendix F) indicates some negative impact to non-transit vehicles while providing transit benefit (outbound only). |
| Medium Investment | <p>Option Y2 – Continuous Transit Lane both directions – Windsor to Kempt</p>  <p>*Proposed cross section looking west</p> | <ul style="list-style-type: none"> • Provide a continuous outbound transit lane; • Provide a continuous inbound transit lane between Windsor Street and Kempt Road; and, • Install lane for left turning vehicles for driveways and intersections. <p><u>Impacts:</u></p> <ul style="list-style-type: none"> • Provides outbound transit priority between Robie Street and Windsor Street. • Provides inbound transit priority between Windsor Street and Kempt Road. • Improved flow of traffic along the corridor is expected during peak periods. • Requires some property acquisition. • Positive for safety with left turn lane. • Increases pedestrian crossing distances. • Analysis (Appendix F) indicates minimal impact to non-transit vehicles while providing transit benefit. |
| High Investment | <p>Option Y3 – Continuous Transit Lane both directions – full corridor</p>  <p>*Proposed cross section looking west</p> | <ul style="list-style-type: none"> • Provide a continuous transit lane in both directions; • Install lane for left turning vehicles for driveways and intersections; • Install eastbound right turn lane at Robie Street and restrict the right turn channel to transit only; and, • Install traffic signals at the Monaghan Drive intersection. <p><u>Impacts:</u></p> <ul style="list-style-type: none"> • Provides a continuous transit lane in both directions for the full corridor. • Positive for safety with left turn lane. • Increases pedestrian crossing distances. • Requires some property acquisition. • Requires realignment of right turn channel at Robie Street and restriction to non-Transit vehicles. • Analysis (Appendix F) indicates minimal impact to non-transit vehicles while providing significant transit benefit. |

4.3 YOUNG STREET OPTIONS EVALUATION

Using the available data, traffic flow models were created using SimTraffic to develop estimates for changes in user delay with each option. Table 4-3 summarizes the benefits to transit and non-transit users and the estimated implementation costs (See Appendix D). Reducing the eastbound through lanes to a single lane for all eastbound transit and non-transit traffic in option Y1 contributed to low overall user benefit. The continuous transit lane provided in Option Y3 means that transit and non-transit vehicles will experience reduced merge delay as well as more continuous flow by transit vehicles.

Table 4-3 - Young Street - Overall Corridor Options Summary

| | Y1 - Continuous outbound Transit Lane | Y2 - Continuous Transit Lane both directions - Windsor to Kempt | Y3- Continuous Transit Lane both directions - full corridor |
|--|---------------------------------------|---|---|
| Total Estimated Annual Cost Savings to Halifax Transit | \$6,500.00 | \$11,800.00 | \$13,700.00 |
| Total Estimated Daily Reduction in Transit User Delay | 8 user hours | 10 user hours | 15 user hours |
| Total Estimated Daily Reduction in Overall User Delay | 1 user hour | 15 user hours | 20 user hours |
| Total Estimated Implementation Cost | \$230,000 | \$630,000 | \$1,400,000 |

A summary of the considerations that impact the multimodal aspects along this corridor is presented in Table 4-4 with red shading indicating negative impacts and green shading indicating positive impacts with grey indicating that the factor is not applicable to the Option.

Table 4-4 - Young Street Options - MMLOS Accommodation Summary

| Mode | Description | Option / Evaluation Considerations | | |
|-------------------|--|------------------------------------|-----------|-----------|
| | | Option Y1 | Option Y2 | Option Y3 |
| Pedestrians | Longer pedestrian crossings at Monaghan Drive crosswalk. | | | |
| | Longer pedestrian crossings at Kempt Road. | | | |
| | Reduced vehicle conflicts at Robie Street right turn channel. | | | |
| Cyclists | Opportunity to permit bikes in curbside transit lane (outbound only in Y1). | | | |
| Halifax Transit | Provides a transit lane in the outbound direction | | | |
| | Provides transit lanes in the inbound direction between Windsor Street and Kempt Road. | | | |
| | Provides inbound transit lanes for the full corridor. | | | |
| Heavy Trucks | Travel lanes are narrowed and Outbound through trucks are restricted from using the curb lane. | | | |
| | Inbound through trucks are restricted from using the curb lane. | | | |
| | Trucks are no longer permitted to use the right turn channel at Robie Street. | | | |
| Vehicular Traffic | Provides left turn lanes for driveways. | | | |
| | Removes one through lane in each direction for non-transit | | | |
| | Restricts non-transit vehicles from the right turn channel at Robie Street. | | | |
| | Improved lane alignment for eastbound traffic. | | | |

Attachment A

An options evaluation matrix was created in order to display the overall assessment of each option and enable comparison between categories (See Table 4-5). As presented, the evaluation matrix is a visual tool that enables high level options comparison.

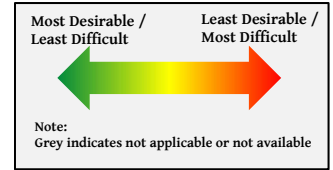

Table 4-5 Young Street Options Evaluation Summary Matrix

| | Transit Corridor Options | | | Description |
|---------------------------------------|--------------------------|---|---|--|
| | Existing Conditions | Y1. Continuous Transit Lane - outbound only | Y2. Continuous Transit Lanes - EB ends at Kempt | |
| Transit Travel Time | Orange | Yellow | Light Green | Improved transit travel time with dedicated lanes. Option Y1 outbound only. |
| Walking | Yellow | Yellow | Yellow | Longer Pedestrian crossings for Y2, Y3, however separation from higher through volume. |
| Bicycling | Orange | Orange | Orange | No major impacts to cycling, some benefits if bicycling permitted in transit lane. |
| Traffic and Heavy Vehicle Flow | Yellow | Orange | Orange | Reduced to one lane in each direction. |
| Road Safety | Yellow | Light Green | Light Green | Added left turn lanes for all options. Improved lane balance for Option Y3. |
| Green space / Urban Forest | Yellow | Yellow | Orange | Option Y1, Y2: No major impacts. Option Y3: Impact to some trees. |
| Property Requirements | Grey | Yellow | Orange | Some widening for Options Y2 and Y3. |
| Implementation Cost | Grey | Yellow | Orange | Option Y1, Y2: Lower capital cost Option Y3: Requires modifications to curb and right turn channel. |
| Public Feedback Response | Grey | Yellow | Light Green | Overall, public indicated preference for transit improvements. |

Note: Parking is already prohibited and there is no proposed change to on-street parking.

Attachment A

Each option for the full corridor was evaluated using the payback period analysis methodology included in *Moving Forward Together Plan* (Halifax Transit, 2016) and summarized in Section 3.4.1. The methodology is included in Appendix E with results summarized in Table 4-6. With a single inbound through lane for mixed traffic there is found to be an increase in user delay inbound (and decrease outbound) for Y1, yielding minimal benefit in overall user delay. Option Y3 offers improved delay savings compared to Y2 due to the continuous lane.

Table 4-6 - Overall Analysis - Young Street

| | | Young Street | | |
|---|--------------------------------------|--|---|--|
| | | Y1- Continuous Transit Lane (Outbound Only) | Y2- Continuous Transit Lanes -Inbound to Kempt | Y3- Continuous Transit Lanes - Full Corridor ² |
| Estimated Daily Delay Savings to Transit Users | | ~8 user hours | ~10 user hours | ~15 user hours |
| Estimated Daily Delay Savings to All Road Users | | ~1 user hour | ~15 user hours | ~20 user hours |
| Payback Period | | ~40 years | ~8 years | ~14 years |
| Combined Score for Delay and Payback | | 3 | 9 | 9 |
| Other Key Factors | Safety Considerations | (+)Improvement with left turn lanes | | (+)Improvement with left turn lanes (++)Improved lane balance between Robie/Kempt intersections |
| | Impact to Other Users | Minimal | Longer Pedestrian Crossings/sidewalk setback from higher volume (-) Impact to properties | |
| | Project Integration | None Identified | | |
| | TPM Enforcement Requirements | Enforcement of typical signage required | | |
| | Issues to Implementation | Slight Property Acquisition Required | (-)Property Acquisition Required | |
| | Promotion of Transit | Some Promotion of Transit | (+)Good Promotion of Transit | |
| | Schedule Adherence | (+)Improvement in outbound direction | (+)Improved schedule adherence, both directions | (++)Improved schedule adherence, both directions full corridor |
| | Public Consultation | Generally seen as the least desirable option | (+)Generally viewed as a good option | (++)Generally viewed as the best option |
| | Score for Other Factors ¹ | 2 | 2 | 6 |
| Overall Evaluation | | 5 | 11 | 15 |
| NOTES: 1. Score for other factors is the sum of the positive impacts less the negative impacts. Impacts with "++" or "--" receive double score. 2. Costs and benefits of signalization of Monaghan Drive have been excluded as this signalization can be done for any option, independently of the transit priority. | | | | |

Comparative evaluation of the user impacts (Table 4-5) and payback analysis (Table 4-6) indicates that the highest overall benefit is provided with Option Y3 (Continuous transit lanes – full corridor). This option provides a continuous transit lane in both directions that connects to planned measures on Bayers Road and Robie Street.

If HRM chooses to implement Option Y2 then it should be considered an interim option due to the lane balance and weaving through the Kempt to Robie section. With its added advantages that it ties into the Robie Street corridor, **Option Y3 should ultimately be considered for implementation by HRM.**

5 ROBIE STREET

5.1 EXISTING CONDITIONS

Robie Street between Young Street and Spring Garden Road (approximately 2.5 km) is an arterial roadway, becoming a major collector between Spring Garden Road and Inglis Street. In this area the roadway transitions from north to south as follows:

- Five lane cross section (Young to Almon, See Figure 5-1)
- Two lanes with parking (Almon to Cunard, See Figure 5-2)
- Four to six lanes with a centre median and added turn lanes at intersections (Cunard to Inglis, See Figure 5-3)

These variances in cross section create operational challenges at several intersections. Most notably at Cunard Street, where the poor alignment requires a separate northbound left protected only traffic signal phase, to reduce the potential for vehicle path overlap between northbound left turning and through traffic (See Figure 5-4).

Traffic data obtained by HRM Traffic Management indicate a weekday two-way traffic volume of between 15,000 and 25,000 vehicles per day (vpd).



Figure 5-1 - Typical Cross Section Looking North - Almon Street to Young Street



Figure 5-2 - Typical Cross Section Looking North - Almon Street to Cunard Street

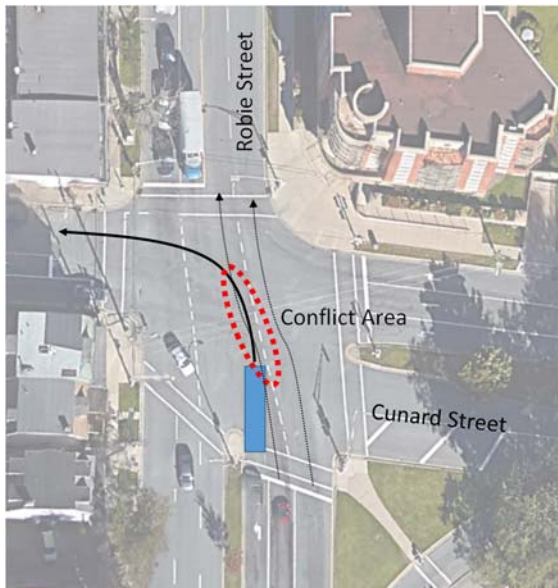

Figure 5-4 Conflict Area caused by poor alignment at Cunard Street intersection



Figure 5-3 - Typical Cross Section Looking North - Inglis Street to Cunard Street

5.1.1 EXISTING TRANSIT

Robie Street serves a variety of transit routes along the approximately 3.5 km study corridor (See Figure 5-5). The 1.2 km segment between Cunard Street and Spring Garden Road in particular serves Routes 7, 17, 18, 23, 42, 80, 81, and 90 with approximately 40 two-way buses during each of the AM and PM peak hours carrying approximately 780 (AM) transit riders and 720 (PM) transit riders.

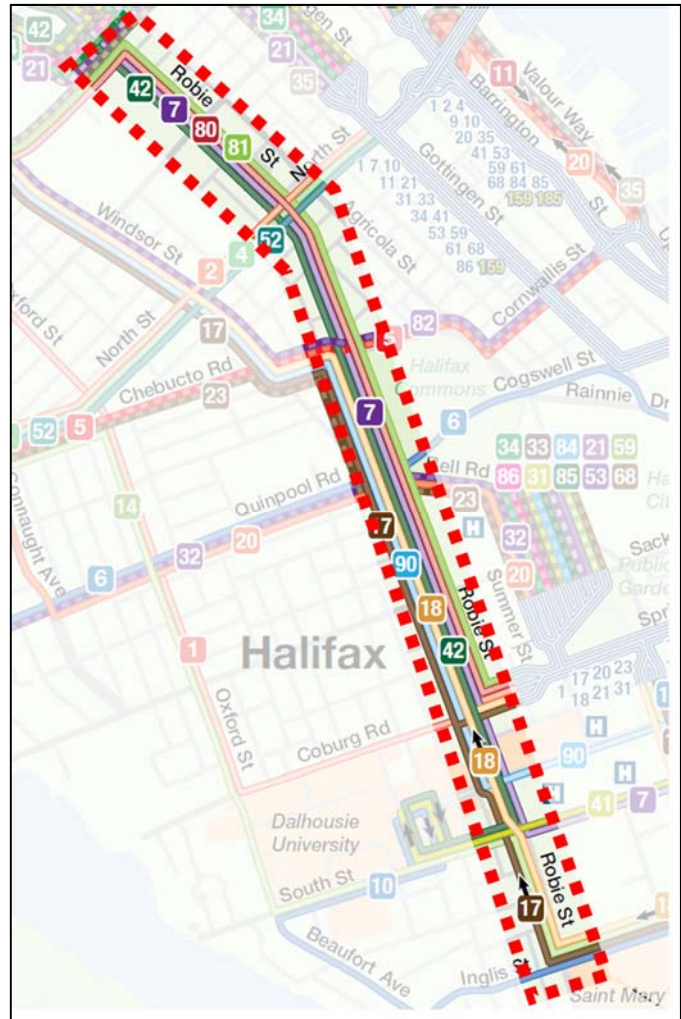

Figure 5-5 - Halifax Transit Routes on Robie Street

| AM Peak Hour | | PM Peak Hour | |
|---|--|--------------|--|
| <p>Robie Street</p> <p>830 660</p> <p>205 565 40</p> <p>Almon St</p> <p>45 195 260</p> <p>430 150 290 490 50</p> <p>345</p> | <p>Robie Street</p> <p>530 1075</p> <p>130 380 20</p> <p>Almon St</p> <p>125 470 610</p> <p>630 190 445 195 60</p> <p>225</p> | | |
| <p>Almon St</p> <p>30 465 15</p> <p>655 510</p> <p>Robie Street</p> <p>740 520</p> <p>10 655 75</p> <p>Cunard St</p> <p>25 160 240</p> <p>220 10 510 410 90</p> <p>305</p> | <p>Almon St</p> <p>30 760 10</p> <p>455 800</p> <p>Robie Street</p> <p>650 855</p> <p>50 645 55</p> <p>Cunard St</p> <p>75 475 615</p> <p>575 20 380 300 60</p> <p>415</p> | | |
| <p>Cunard St</p> <p>50 470 20</p> <p>785 540</p> <p>Robie Street</p> <p>1015 580</p> <p>50 750 215</p> <p>Spring Garden Road</p> <p>115 150 310</p> <p>250 45 215 170</p> <p>410</p> | <p>Cunard St</p> <p>50 760 60</p> <p>670 870</p> <p>Robie Street</p> <p>540 965</p> <p>35 385 120</p> <p>Spring Garden Road</p> <p>180 315 535</p> <p>510 55 190 135</p> <p>285</p> | | |
| <p>Coburg Road</p> <p>50 420 25</p> <p>795 495</p> <p>Robie Street</p> <p>850 435</p> <p>50 455 345</p> <p>University Avenue</p> <p>95 85 210</p> <p>145 30 200 145 25</p> <p>530</p> | <p>Coburg Road</p> <p>160 730 30</p> <p>425 920</p> <p>Robie Street</p> <p>450 940</p> <p>45 270 135</p> <p>University Avenue</p> <p>225 145 395</p> <p>220 45 165 100 20</p> <p>265</p> | | |
| <p>University Avenue</p> <p>10 310 40</p> <p>510 360</p> | <p>University Avenue</p> <p>30 670 30</p> <p>315 730</p> | | |

Figure 5-6 - Robie St observed AM and PM peak hour traffic volumes

5.1.2 EXISTING TRAFFIC

Turning movement counts at the signalized intersections along Robie Street were collected by HRM Traffic Management for the morning (7-9 AM) and afternoon (4-6 PM) peak periods. Observed AM and PM peak hour volumes at several of the key intersections are summarized in Figure 5-6. Traffic analysis of design hourly volumes, prepared using Synchro 9 and SimTraffic, is summarized in Appendix G.

5.1.3 EXISTING MULTIMODAL ACCOMMODATION

A summary of the considerations that impact the multimodal aspects along this corridor are presented in Table 5-1.

Table 5-1 – Robie Street – Existing MMLoS Accommodation Summary

| Mode | Evaluation Considerations |
|--------------------------|--|
| Pedestrians | There is sidewalk along both sides of this corridor. Pedestrian crossing distances vary by segment, ranging from 3 lanes to 6 lanes with a median. Marked pedestrian crossings are at signalized or RA-5 crosswalks with pushbuttons and flashing beacons. |
| Cyclists | No bicycle facilities are present along this corridor. North-south bicycle lanes are in place on Windsor Street. |
| Halifax Transit | No special Transit lanes exist along this corridor. Many transit stops are setback from the lane within the parking lane areas. |
| Heavy Trucks | HRM By-law T-400 (Truck Route By-law) designates Robie Street as a full-time truck route. Curbside lanes along Robie Street are moderate in width, however parked vehicles encroach onto these lanes. Misaligned intersections at Almon, Cunard, and Quinpool create potential for offtracking issues. |
| Vehicular Traffic | Robie Street is primarily 2 through lanes in each direction for the majority of its length (1 through lane each direction from Cunard to Almon). Significant queuing has been observed during peak periods, particularly at the Quinpool intersection. While the majority of the intersections have existing left turn lanes on Robie Street in each direction, notable exceptions include southbound at Cunard, and northbound at Almon and Coburg. |

5.1.4 ROAD SAFETY

Collision reports were not available for this corridor for collision analysis. A comparative analysis between the options for this corridor considered how each option may be expected to change the number or type of conflict points as well as how changes to delay/queues on sidestreets may impact intersections along adjacent corridors.

5.1.5 EXISTING ON-STREET PARKING

On-street parking is permitted on Robie Street through much of this corridor. An inventory of available parking spaces was completed to estimate the number of on-street spaces that may be impacted by implementing transit priority on this corridor.

There are approximately 210 parking spaces (including 48 parking meters and one accessible parking space) along Robie Street in this corridor with an approximate breakdown as summarized in Table 5-2 and displayed in Figure 5-7.

Table 5-2 - Existing Available Parking Spaces - Robie Street Corridor

| Segment | | Estimated # of Spaces | Approximate Segment Length |
|--------------|------------------|-----------------------|----------------------------|
| Robie Street | Young to Jubilee | ~60 spaces | 2.0 km |
| | Jubilee to South | ~80 spaces | 0.75 km |
| | South to Inglis | ~70 spaces | 0.5 km |

In addition to the noted parking spaces there are approximately 3 loading zone spaces and one 3-vehicle taxi stand.

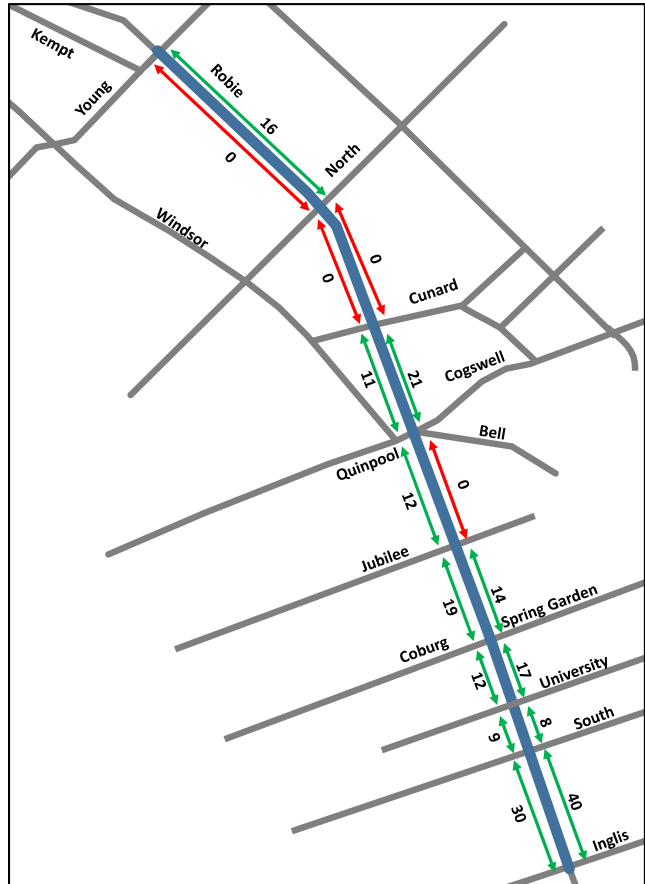

Figure 5-7 - Existing On-street Parking on Robie Street Corridor

5.2 ROBIE STREET MODIFICATION OPTIONS

With the changing road width and varying traffic and transit volumes along Robie Street, this corridor has been separated into the following four segments (See Figure 5-8) for the development and evaluation of transit priority options:

1. Young Street to Almon Street;
2. Almon Street to Cunard Street;
3. Cunard Street to Coburg Road; and,
4. Coburg Road to Inglis Street.

Recognizing the congestion, the high traffic volumes, the importance of this corridor as a truck and traffic route to / from Peninsular Halifax, and the priorities for allocation of street space, options have been prepared for each of the segments of this corridor. These options for each segment are shown conceptually in Appendix A and described in subsequent sections of this report.

Robie Street Segments Considered:
 1) Young Street to Almon Street
 2) Almon Street to Cunard Street
 3) Cunard Street to Coburg Road
 4) Coburg Road to Inglis Street

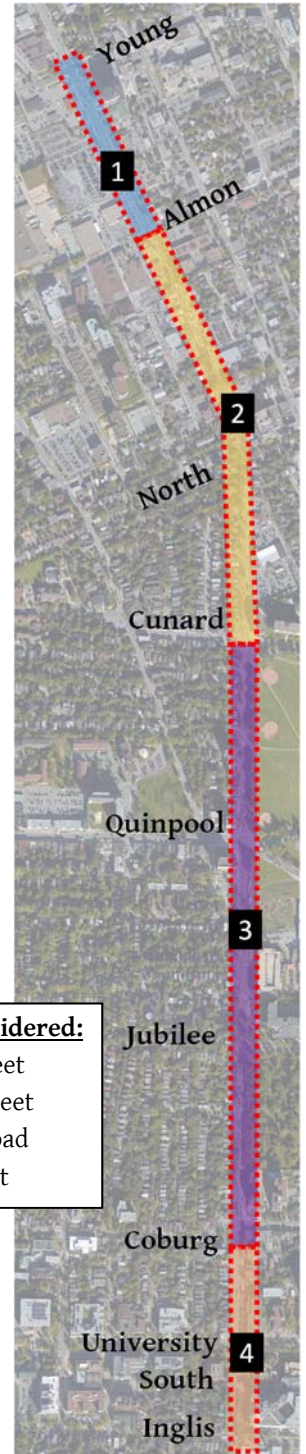

Figure 5-8 - Robie Street Segments Considered in this Study

Lane Requirements:

At the outset of the project, traffic analysis was prepared to assess the lane requirements for each segment of the corridor. Analysis considered whether reductions to one through lane in each direction for non-transit could accommodate the traffic volumes without causing significant queue spillback and negative impact to non-transit vehicle operations or to transit and traffic queuing on side streets.

Intersection analysis results with reduction to a single lane in each direction on Robie Street (See Table 5-3) indicate that:

- A second southbound through lane should be retained from Quinpool Road and ending at Coburg Road / Spring Garden Road; and,
- A second northbound through lane should be retained south of University Avenue (due to the close proximity with the South Street intersection and ending north of Quinpool Road. This is expected to create more gaps in traffic flow to better accommodate southbound left turning buses).

Recommended non-Transit through lanes on Robie Street are indicated in Figure 5-9. Additional turn lanes may be required at intersections.

For each segment of Robie Street options were prepared that included analysis and review of Curbside bus lanes and Median bus lanes. An overview of each lane type is included in 3.2.

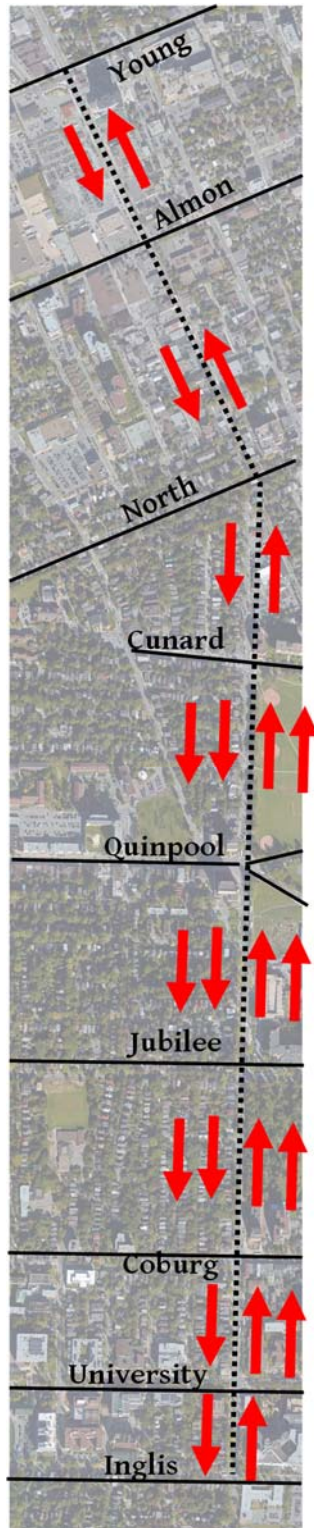

Figure 5-9 - Recommended Robie St Non-Transit Through Lanes

Table 5-3 – AM and PM Robie Street Intersection Analysis Results – (One Lane, Each Direction)

| | | Analysis Criteria | Control Delay (sec/veh), v/c Ratio, and 95 th % Queue (m) by Intersection Movement | | | | | |
|---------------------------------------|------------|-------------------|---|-------|-------|-------|-------|------|
| | | | NB-L | NB-T | NB-R | SB-L | SB-T | SB-R |
| Robie Street AM Design Hourly Volumes | @ Young | Delay | 32.4 | 19.0 | 3.5 | 15.7 | 31.4 | 4.4 |
| | | v/c | 0.54 | 0.55 | 0.03 | 0.20 | 0.84 | 0.10 |
| | | Queue | 40.0 | 123.4 | 3.0 | 17.5 | 262.7 | 9.4 |
| | @ Almon | Delay | 50.0 | 29.3 | 0.1 | 53.1 | 31.9 | 3.5 |
| | | v/c | 0.26 | 0.71 | 0.03 | 0.35 | 0.78 | 0.31 |
| | | Queue | 16.2 | 118.6 | 0.0 | 20.2 | 150.9 | 12.4 |
| | @ Cunard | Delay | 25.7 | 26.5 | 5.7 | 38.4 | 50.2 | 4.7 |
| | | v/c | 0.27 | 0.62 | 0.10 | 0.32 | 0.82 | 0.02 |
| | | Queue | 13.6 | 97.5 | 7.4 | 22.2 | 164.7 | 0.0 |
| | @ Quinpool | Delay | 52.1 | 204.5 | 56.2 | 62.2 | 417.2 | 0.5 |
| | v/c | 0.69 | 1.31 | 0.26 | 0.86 | 1.84 | 0.11 | |
| | Queue | 60.7 | 243.8 | 22.1 | 138.8 | 452.1 | 0.0 | |
| @ Jubilee | Delay | 156.6 | 31.3 | 3.5 | 21.7 | 60.1 | 2.9 | |
| | v/c | 0.98 | 0.67 | 0.09 | 0.65 | 1.02 | 0.04 | |
| | Queue | 39.2 | 140.7 | 5.4 | 36.1 | 339.0 | 2.8 | |
| @ Coburg | Delay | 19.2 | 22.7 | 0.2 | 11.4 | 20.0 | 2.6 | |
| | v/c | 0.23 | 0.60 | 0.05 | 0.49 | 0.77 | 0.07 | |
| | Queue | 15.2 | 103.8 | 0.0 | 31.6 | 190.2 | 4.8 | |
| @ University | Delay | 18.2 | 24.0 | 18.9 | 12.2 | 12.5 | 4.0 | |
| | v/c | 0.04 | 0.48 | 0.10 | 0.62 | 0.51 | 0.07 | |
| | Queue | 6.0 | 89.4 | 14.0 | 49.8 | 85.0 | 6.3 | |

| | | Analysis Criteria | Control Delay (sec/veh), v/c Ratio, and 95 th % Queue (m) by Intersection Movement | | | | | |
|---------------------------------------|------------|-------------------|---|-------|-------|-------|-------|------|
| | | | NB-L | NB-T | NB-R | SB-L | SB-T | SB-R |
| Robie Street PM Design Hourly Volumes | @ Young | Delay | 19.5 | 57.8 | 0.1 | 89.4 | 34.9 | 3.3 |
| | | v/c | 0.52 | 1.00 | 0.02 | 0.70 | 0.70 | 0.13 |
| | | Queue | 34.8 | 305.1 | 0.0 | 28.6 | 28.6 | 7.0 |
| | @ Almon | Delay | 15.6 | 51.4 | 0.0 | 41.7 | 27.6 | 10.0 |
| | | v/c | 0.09 | 0.96 | 0.02 | 0.38 | 0.46 | 0.21 |
| | | Queue | 9.6 | 276.0 | 0.0 | 6.8 | 89.1 | 13.2 |
| | @ Cunard | Delay | 17.1 | 35.1 | 5.2 | 38.6 | 22.9 | 4.0 |
| | | v/c | 0.17 | 0.86 | 0.09 | 0.52 | 0.62 | 0.08 |
| | | Queue | 12.9 | 264.8 | 8.6 | 31.0 | 142.1 | 6.2 |
| | @ Quinpool | Delay | 96.4 | 410.1 | 47.2 | 70.6 | 273.6 | 0.7 |
| | v/c | 1.00 | 1.82 | 0.31 | 0.87 | 1.50 | 0.15 | |
| | Queue | 129.2 | 475.0 | 32.8 | 101.8 | 336.7 | 0.0 | |
| @ Jubilee | Delay | 31.9 | 38.2 | 3.2 | 45.7 | 40.3 | 1.1 | |
| | v/c | 0.74 | 0.98 | 0.10 | 0.74 | 0.86 | 0.08 | |
| | Queue | 26.8 | 129.9 | 0.7 | 40.2 | 216.8 | 1.3 | |
| @ Coburg | Delay | 11.7 | 73.6 | 0.2 | 36.1 | 29.1 | 6.8 | |
| | v/c | 0.39 | 1.04 | 0.06 | 0.65 | 0.50 | 0.07 | |
| | Queue | 26.2 | 286.5 | 0.0 | 28.3 | 83.6 | 1.0 | |
| @ University | Delay | 14.3 | 55.3 | 14.4 | 13.0 | 10.7 | 4.0 | |
| | v/c | 0.07 | 0.96 | 0.07 | 0.50 | 0.32 | 0.07 | |
| | Queue | 8.6 | 232.3 | 8.9 | 19.0 | 44.5 | 5.6 | |

5.2.1 YOUNG STREET TO ALMON STREET

Robie Street from Young to Almon, has two through lanes in each direction and a centre left turn lane. This segment experiences heavy traffic volumes during the AM and PM peak periods. Two modification options (plans included in Appendix A) were prepared for this segment and are summarized below. Intersection analysis is included in Appendix G.

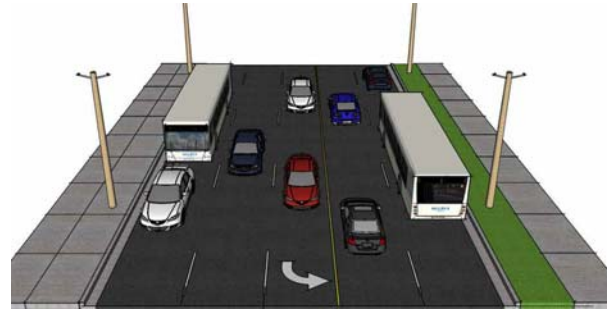
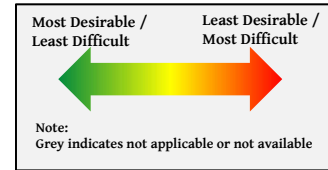

Figure 5-10 - Existing Cross Section (Young to Almon, looking north)

| Option - Robie Street (Young to Almon) | | Description |
|--|--|---|
| Curbside Transit Lanes | <p>1 - Provide Continuous Curbside Transit Lanes</p> <p>*Proposed cross section looking north</p> | <ul style="list-style-type: none"> Modify curb lanes as transit-only lanes. <p><u>Impacts:</u></p> <ul style="list-style-type: none"> Provides a full-time continuous transit lane in both directions. Removes transit vehicles and right turns from flow of non-transit vehicles. Shortens the southbound right turn lane for Almon Street by designating as transit only. Shortens the northbound through-right lane for non-transit at Young Street. Loss of one traffic lane in each direction. |
| Median Transit Lanes | <p>2 - Provide Continuous Median Transit Lanes</p> <p>*Proposed cross section looking north</p> | <ul style="list-style-type: none"> Widen on west side and provide median transit lanes. <p><u>Impacts:</u></p> <ul style="list-style-type: none"> Requires some property acquisition on west side of Robie Street. Provides full-time separated transit lanes. Relocates transit stops to centre of roadway. Restricts left turns except at signalized intersections. Removes bus conflicts with right turning vehicles. Setback of crosswalks required to accommodate turning traffic and the need for a pedestrian refuge at Almon Street. Accessibility implications where centre platforms must accommodate all users. Reduces left turn conflicts. Loss of one traffic lane in each direction. |

Attachment A

An options evaluation matrix was created in order to display the overall assessment of each option and enable comparison between categories (See Table 5-4).



**Table 5-4 - Robie Street - Young Street to Almon Street
Options Evaluation Summary Matrix**

| | Transit Corridor Options | | | Description |
|---------------------------------------|--------------------------|----------------------|--------------------|--|
| | Existing Conditions | 1 Curbside Bus Lanes | 2 Median Bus Lanes | |
| Transit Travel Time | | | | Improved transit travel time with dedicated lanes. |
| Walking | | | | Longer pedestrian crossings with median bus lanes, offsets slight benefit from medians at signalized crossings. |
| Bicycling | | | | Median lanes: Bicyclists must cycle in mixed traffic. Curbside lanes: Opportunity to widen curb lane for buses / bikes. |
| Traffic and Heavy Vehicle Flow | | | | Reduced to one lane in each direction. Left turn protected phases required with median lanes. |
| Road Safety | | | | Median bus lanes offer some safety benefits compared to curbside bus lanes. |
| Green space / Urban Forest | | | | Area between transit stops offers opportunity for added green space. |
| Property Requirements | | | | No widening for curbside lanes, some property required with median lanes |
| Implementation Cost | | | | Pavement marking and signage only for curbside lanes. Widening required for median lanes. |
| Public Feedback Response | | | | Overall, public indicated preference for curbside lanes. |

Note: Parking is already prohibited and there is no proposed change to parking.

5.2.2 ALMON STREET TO CUNARD STREET

Robie Street from Almon to Cunard has a single through lane in each direction and intermittent on-street parking on the east side. This segment experiences moderate traffic volumes and congestion during the AM and PM peak periods. Three modification options (plans included in Appendix A) were prepared for this segment and are summarized below. Intersection analysis is included in Appendix G.



Figure 5-11 – Existing Cross Section (Almon to Cunard, looking north)

| Option – Robie (Almon to Cunard) | | Description |
|----------------------------------|---|---|
| Curbside Transit Lanes | <p>1 – Provide Continuous Curbside Transit Lane (NB Only)</p> <p>*Proposed cross section looking north</p> | <ul style="list-style-type: none"> Remove parking and add northbound transit-only lane. Widen at North Street intersection to install northbound right turn lane. <p><u>Impacts:</u></p> <ul style="list-style-type: none"> Provides a full-time continuous northbound transit lane. Removes transit vehicles and right turns from flow of non-transit vehicles. Requires some property and impact to one tree. Removes parking. |
| | <p>2 – Provide Continuous Curbside Transit Lanes</p> <p>*Proposed cross section looking north</p> | <ul style="list-style-type: none"> Remove parking and widen along full corridor and install transit-only lanes in both directions. Install northbound right turn lane at North Street intersection. <p><u>Impacts:</u></p> <ul style="list-style-type: none"> Provides a full-time continuous transit lane in both directions. Removes transit vehicles and right turns from flow of non-transit vehicles. Requires property acquisition and impacts to several trees. Removes parking. |

Attachment A

| | | |
|----------------------|--|--|
| Median Transit Lanes | 3 – Provide Continuous Median Transit Lanes | <ul style="list-style-type: none"> Remove parking and widen along full corridor and install median transit-only lanes in both directions. Install northbound right turn lane at North Street intersection. Restrict left turns from/to unsignalized driveways and side streets. <p><u>Impacts:</u></p> <ul style="list-style-type: none"> Provides full-time separated transit lanes. Relocates transit stops to centre of roadway. Requires extensive property acquisition and impacts to several trees. Restricts left turns except at signalized intersections. Removes parking. Removes bus conflicts with right turning vehicles. Setback of crosswalks required to accommodate turning traffic and the need for a pedestrian refuge at Almon Street and North Street. Accessibility implications where centre platforms must accommodate all users. |
| |  <p>*Proposed cross section looking north</p> | |

An options evaluation matrix was created in order to display the overall assessment of each option and enable comparison between categories (See Table 5-5).

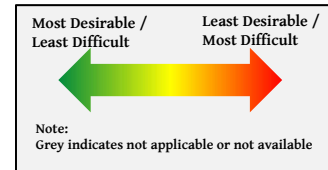

Table 5-5 – Robie Street – Almon Street to Cunard Street
Options Evaluation Summary Matrix

| | Transit Corridor Options | | | Description | |
|------------------------------------|--------------------------|-----------------------|-------------------------------|-------------|--|
| | Existing Conditions | 1-Curb-side (NB Only) | 2-Curb-side (Both Directions) | | 3-Median (Both Directions) |
| Transit Travel Time | | | | | Improved transit travel time with dedicated lanes. Option Y1 outbound only. |
| Walking | | | | | Longer and offset pedestrian crossings with median bus lanes. Longer pedestrian crossings with curbside lanes in both directions |
| Bicycling | | | | | Median lanes: Bicyclists must cycle in mixed traffic. Curbside lanes: Opportunity to widen curb lane for buses / bikes. |
| Traffic and Heavy Vehicle Flow | | | | | Median lanes: Protected only left turn phases increase delay. |
| Road Safety | | | | | Realignment of intersections at Almon Street, Cunard Street for Options 2 and 3. |
| Green space / Urban Forest | | | | | Some impact to trees for Option 1. Significant impact to trees for Options 2 and 3. |
| Onstreet Parking / Loading Impacts | | | | | Prohibits onstreet parking in all options. |
| Property Requirements | | | | | Road widening required for Curbside bus lanes, significant widening for Median bus lanes |
| Implementation Cost | | | | | Curb and sidewalk modifications required for Option 2. Significant road reconstruction for Option 3. |
| Public Feedback Response | | | | | Overall, public indicated preference for curbside lanes. |

5.2.3 CUNARD STREET TO COBURG ROAD / SPRING GARDEN ROAD

Robie Street from Cunard to Coburg has a median separating multiple lanes in each direction with on-street parking provided along much of the corridor. There are heavy traffic volumes and congestion at several of the intersections (particularly at the Quinpool Road intersection) during the AM and PM peak periods. Two modification options (plans included in Appendix A) were prepared for this segment and are summarized below. Intersection analysis is included in Appendix G.

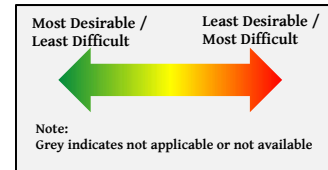

Figure 5-12 - Existing Cross Section (Cunard to Coburg, looking north)

| Option - Robie Street (Cunard to Coburg) | | Description |
|--|--|--|
| Curbside Transit Lanes | <p>1 - Provide Continuous Curbside Transit Lanes</p> <p>*Proposed cross section looking north</p> | <ul style="list-style-type: none"> • Modify curb lanes as transit-only lanes. • Remove median at several intersections. • Realign intersections at Cunard and at Quinpool. <p><u>Impacts:</u></p> <ul style="list-style-type: none"> • Provides a full-time continuous transit lane in both directions. • Removes transit vehicles and right turns from flow of non-transit vehicles. • Median modifications remove pedestrian refuges at several intersections. • Removes parking. |
| Median Transit Lanes | <p>2 - Provide Continuous Median Transit Lanes</p> <p>*Proposed cross section looking north</p> | <ul style="list-style-type: none"> • Provide median transit lanes. • Realign intersections at Cunard and at Quinpool <p><u>Impacts:</u></p> <ul style="list-style-type: none"> • Requires significant property acquisition. • Provides full-time separated transit lanes. • Relocates transit stops to centre of roadway. • Removes parking. • Road widening impacts properties and trees. • Restricts left turns except at signalized intersections. • Removes bus conflicts with right turning vehicles. • Setback of crosswalks required to accommodate turning traffic and the need for a pedestrian refuge at Cunard Street, Jubilee Road, and Spring Garden Road. • Accessibility implications where centre platforms must accommodate all users. |

Attachment A

An options evaluation matrix was created in order to display the overall assessment of each option and enable comparison between categories (See Table 5-6).



**Table 5-6 - Robie Street - Cunard Street to Coburg Road
Options Evaluation Summary Matrix**

| | Transit Corridor Options | | | Description |
|------------------------------------|--------------------------|----------------------|--------------------|--|
| | Existing Conditions | 1 Curbside Bus Lanes | 2 Median Bus Lanes | |
| Transit Travel Time | Red | Green | Light Green | Improved transit travel time with dedicated lanes. |
| Walking | Yellow | Yellow | Orange | Longer and offset pedestrian crossings with median bus lanes. Adjustment to centre median for curbside option. |
| Bicycling | Orange | Yellow | Orange | Curbside lanes: Potential to accommodate bikes along transit lane. Median lanes: Bicyclists must cycle in mixed traffic. |
| Traffic and Heavy Vehicle Flow | Orange | Yellow | Red | Curbside option: Some improvement to traffic Median option: Protected only left turn phases increase delay, particularly at Quinpool Rd. Left turn restrictions increase travel distance. |
| Road Safety | Orange | Light Green | Light Green | Realignment of intersections at Cunard Street and Quinpool Road. |
| Green space / Urban Forest | Yellow | Yellow | Red | New green space available at Common along Section. Curbside Option: Some impact to trees. Median Option: Significant impact to trees. |
| Onstreet Parking / Loading Impacts | Grey | Red | Red | Remove all on-street parking from Robie Street in all options. |
| Property Requirements | Grey | Light Green | Orange | Curbside option: Property being given back to Common and minimal widening. Median option: Some property being given back to Common, significant widening required |
| Implementation Cost | Grey | Yellow | Red | Pavement marking and signage only for curbside lanes. Widening required for median lanes. |
| Public Feedback Response | Grey | Green | Light Green | Overall, public indicated preference for curbside lanes. |

5.2.4 COBURG ROAD TO INGLIS STREET

Robie Street (Coburg to Inglis) has a median separating multiple lanes in each direction. On-street parking is provided along both sides through the corridor. This segment experiences moderate traffic volumes and congestion at several of the intersections, and heavy left turn volumes from Robie Street at each of the major intersections during the AM and PM peak periods. Two modification options (plans included in Appendix A) were prepared for this segment and are summarized below. Intersection analysis is included in Appendix G.

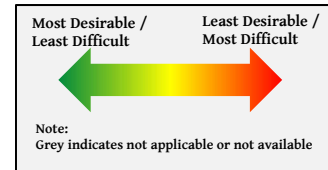

Figure 5-13 - Existing Cross Section (Coburg to Inglis, looking north)

| Option - Robie (Coburg to Inglis) | | Description |
|-----------------------------------|--|--|
| Curbside Transit Lanes | <p>1 - Provide Continuous Curbside Transit Lanes</p> <p>*Proposed cross section looking north</p> | <ul style="list-style-type: none"> • Modify curb lanes as transit-only lanes. • Remove median at several intersections. • Realign intersections at Cunard and at Quinpool. <p><u>Impacts:</u></p> <ul style="list-style-type: none"> • Provides a full-time continuous transit lane in both directions. • Removes transit vehicles and right turns from flow of non-transit vehicles. • Removal of the median for a portion of the corridor. |
| Median Transit Lanes | <p>2 - Provide Continuous Median Transit Lanes</p> <p>*Proposed cross section looking north</p> | <ul style="list-style-type: none"> • Widen on west side and provide median transit lanes. • Realign intersections at Cunard and at Quinpool <p><u>Impacts:</u></p> <ul style="list-style-type: none"> • Requires property acquisition. • Provides full-time separated transit lanes. • Relocates transit stops to centre of roadway. • Restricts left turns except at signalized intersections. • Removes bus conflicts with right turning vehicles. • Setback of crosswalks required to accommodate turning traffic and the need for a pedestrian refuge at Spring Garden Road and South Street. • Accessibility implications where centre platforms must accommodate all users. |

Attachment A

An options evaluation matrix was created in order to display the overall assessment of each option and enable comparison between categories (See Table 5-7).



**Table 5-7 - Robie Street - Coburg Road to Inglis Street
Options Evaluation Summary Matrix**

| | Transit Corridor Options | | | Description |
|------------------------------------|--------------------------|----------------------|--------------------|--|
| | Existing Conditions | 1 Curbside Bus Lanes | 2 Median Bus Lanes | |
| Transit Travel Time | Orange | Green | Green | Improved transit travel time with dedicated lanes. |
| Walking | Yellow | Yellow | Orange | Longer and setback pedestrian crossings with median bus lanes. |
| Bicycling | Orange | Yellow | Orange | Median lanes: Bicyclists must cycle in mixed traffic. Curbside lanes: Opportunity to widen curb lane for buses / bikes. |
| Traffic and Heavy Vehicle Flow | Yellow | Yellow | Orange | Median option: Protected only left turn phases increase delay. |
| Road Safety | Orange | Light Green | Light Green | Separation of transit vehicles from mixed traffic. Signal separation of left turns for median option. |
| Green space / Urban Forest | Yellow | Yellow | Red | Curbside Option: Some impact to trees. Median Option: Significant impact to trees. |
| Onstreet Parking / Loading Impacts | Grey | Red | Red | Remove all on-street parking from Robie Street in all options. |
| Property Requirements | Grey | Yellow | Orange | Curbside option: Minimal property impact. Median option: Property impacts with widening. |
| Implementation Cost | Grey | Orange | Red | Curbside option: Lower cost compared to Median option. |
| Public Feedback Response | Grey | Green | Light Green | Overall, public indicated preference for curbside lanes. |

5.3 ROBIE STREET OPTIONS EVALUATION

Recognizing that transit priority for each segment of this corridor should not be considered for implementation in isolation, corridor level options (summarized in Table 5-8) have been developed and evaluated.

Table 5-8 – Robie Street – Overall Corridor Options Summary

| | | Transit Corridor Option - Robie Street | | |
|-------------------|--|--|--|--|
| | | R1 - Curbside Bus Lanes (NB Only Cunard to Almon) | R2 - Curbside Bus Lanes (Both Directions Full Corridor) | R3 - Median Bus Lanes (Both Directions Full Corridor) |
| Corridor Segment | Young to Almon | 1 Continuous Curbside Transit Lanes | | 2 – Provide Continuous Median Transit Lanes |
| | Almon to Cunard | 1 Continuous Curbside Transit Lane (NB Only) | 2 Continuous Curbside Transit Lanes | 3 – Provide Continuous Median Transit Lanes |
| | Cunard to Coburg | 1 Continuous Curbside Transit Lanes | | 2 – Provide Continuous Median Transit Lanes |
| | Coburg to Inglis | 1 Continuous Curbside Transit Lanes | | 2 – Provide Continuous Median Transit Lanes |
| Estimated Results | Total Estimated Annual Operating Cost Savings to Halifax Transit | \$83,000 | \$94,000 | \$62,000 |
| | Total Estimated Daily Reduction in Transit User Delay | 100 user hours | 115 user hours | 100 user hours |
| | Total Estimated Daily Reduction in Overall User Delay | 195 user hours | 220 user hours | -550 user hours |
| | Total Estimated Implementation Cost (full 3.5 km corridor) | \$4,350,000 | \$5,825,000 | \$11,000,000 |

The estimated travel time calculations have not considered modifying signal progression to favour the flow of transit vehicles. These additional modifications (available for all options) may yield improved operations to transit above those projected.

Since the median transit option requires that substantial signal timing duration is provided to accommodate the heavy left turn volumes at several intersections, the median option is found to increase the overall user delay compared to existing operations and provide reduced transit user benefits relative to the Curbside options.

A summary of the considerations that impact the multimodal aspects along this corridor is presented in Table 5-9 with red shading indicating negative impacts and green shading indicating positive impacts with grey indicating that the factor is not applicable to the Option.

Further information on the cost estimates is provided in Section 3.4.5 and cost estimates are included in Appendix D.

Attachment A

Table 5-9 – Robie Street Options – MMLOS Accommodation Summary

| Mode | Description | Option / Evaluation Considerations | | |
|-------------------|---|------------------------------------|-----------|-----------|
| | | Option R1 | Option R2 | Option R3 |
| Pedestrians | Shorter Crossings between Cunard and Quinpool | Green | Green | Green |
| | Longer pedestrian crossings between Almon and Cunard. | Grey | Red | Red |
| | Removed medians at several crossings. | Red | Red | Grey |
| | Longer pedestrian crossings at most intersections. | Grey | Grey | Red |
| | All transit users must cross to / from stations. | Grey | Grey | Red |
| | Setback crosswalks may create sightline concerns for turning traffic. | Grey | Grey | Red |
| Cyclists | Opportunity to permit bikes in curbside transit lane. Reduced travel lane width and mixed traffic for median facility. | Green | Green | Red |
| Halifax Transit | Provides outbound transit lane for the full corridor, provides inbound transit lane for majority of the corridor. | Green | Green | Green |
| | Provides inbound transit lane for the full corridor. | Grey | Green | Green |
| Heavy Trucks | Restricts through trucks from using the curb lanes. | Red | Red | Grey |
| | Left turning trucks from / to Robie at signalized intersections only. | Grey | Grey | Red |
| | Travel lanes are narrowed. | Red | Red | Red |
| Vehicular Traffic | Improved intersections at Cunard, Quinpool, and Coburg. | Green | Green | Green |
| | Improved intersection at Almon. NB Left turn restriction for Option R1. | Red | Green | Green |
| | Significant increase in delay is anticipated. | Grey | Grey | Red |
| | Reduced access with left turn restrictions along entire corridor at unsignalized intersections. | Grey | Grey | Red |
| | Parking is prohibited. | Red | Red | Red |

Attachment A

An options evaluation matrix (See Table 5-10) was created in order to display the overall assessment of each option along Robie Street and enable comparison between categories.

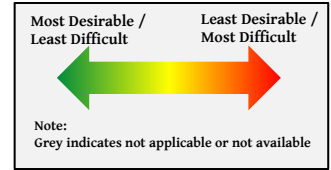

Table 5-10 – Robie Street – Overall Corridor Options Evaluation Summary Matrix

| | Transit Corridor Options | | | Description | |
|------------------------------------|--------------------------|----------------------|------------------------------|-------------|--|
| | Existing Conditions | 1-Curbside (NB Only) | 2-Curbside (Both Directions) | | 3-Median (Both Directions) |
| Transit Travel Time | Red | Green | Green | Green | Improved transit travel time with dedicated lanes. Option Y1 outbound only. |
| Walking | Yellow | Yellow | Yellow | Orange | Options R1 and R2: Adjustment to centre median for curbside option Option R3: Longer and set back pedestrian crossings with median bus lanes. |
| Bicycling | Orange | Orange | Yellow | Orange | Options R1 and R2: Potential to accommodate bikes along transit lane. Option R3: Bicyclists must cycle in mixed traffic in narrowed lane widths. |
| Traffic and Heavy Vehicle Flow | Orange | Orange | Orange | Red | Options R1 and R2: Slight improvement to traffic flow. Median option: Protected only left turn phases increase delay and turn restrictions increase travel distance. |
| Road Safety | Orange | Green | Green | Green | Realignment of intersections at Almon Street, Cunard Street, and Quinpool Road improves vehicle tracking and safety. |
| Green space / Urban Forest | Yellow | Yellow | Orange | Red | Option R1: Minimal impact to trees, new greenspace available at Common. Option R2: Impact to several trees, new greenspace available at Common. Option R3: Significant impact to trees, new greenspace available at Common. |
| Onstreet Parking / Loading Impacts | Grey | Red | Red | Red | Prohibits onstreet parking in all options. |
| Property Requirements | Grey | Yellow | Orange | Red | Option R1: Minimal widening, opportunity to add available surplus ROW to Common. Option R2: Some widening (mainly Almon to Cunard) and opportunity to add available surplus ROW to Common. Option R3: Significant widening along full corridor, opportunity to add some surplus ROW to Common. |
| Implementation Cost | Grey | Yellow | Orange | Red | Curb and sidewalk modifications required for Option 2. Significant road reconstruction for Option 3. |
| Public Feedback Response | Grey | Yellow | Green | Green | Overall, public indicated preference for curbside lanes. |

Attachment A

Each option for the study corridor was evaluated using the payback period analysis methodology (See Appendix E) included in Moving Forward Together Plan (Halifax Transit, 2016) and as described in Section 3.4.1 with results summarized in Table 5-11.

Table 5-11 – Robie Street Corridor Options - Payback Period

| | | Robie Street | | |
|---|--------------------------------------|--|--|--|
| | | R1 Curbside Transit Lanes (NB only Cunard to Almon) | R2 Curbside Transit Lanes (Both Directions Full Corridor) | R3 Median Transit Lanes (Both Directions Full Corridor) |
| Estimated Daily Delay Savings to Transit Users | | ~100 user hours | ~115 user hours | ~100 user hours |
| Estimated Daily Delay Savings to All Road Users | | ~195 user hours | ~220 user hours | ~(550 user hours (negative)) |
| Payback Period to Public | | 4.0 years | 4.6 years | -3.5 years (no payback) |
| Combined Score for Delay and Payback | | 9 | 10 | 0 |
| Other Key Factors | Safety Considerations | (+)Realignment of several intersections | (+)Realignment of several intersections | (+)Collision data for median lanes indicates a benefit relative to curbside lanes (+)Realignment of several intersections (-)Setback pedestrian crosswalks |
| | Impact to Other Users | No major impacts | (-)Longer pedestrian crossings at some intersections (+)Improves operations for emergency vehicles | (-)Longer pedestrian crossings at several intersections (-)Impacts property access Improves operations for emergency vehicles, impacts access to hospital |
| | Project Integration | None Expected | | |
| | TPM Enforcement Requirements | Enforcement of typical transit lane and parking signage | | (-) Requires additional enforcement of turn restrictions |
| | Issues to Implementation | (-)Acquisition of some properties is required Some tree impacts (fewer than R2) | (-)Acquisition of several properties is required (-) Impacts several trees (reduced impact than R3) | (-)Acquisition of several properties required (-) Impacts several trees |
| | Promotion of Transit | (+)Some Promotion of Transit | (++)Excellent Promotion of Transit | (++)Excellent Promotion of Transit |
| | Schedule Adherence | (++)Greatly Improved Schedule adherence while limited to NB only (Cunard to Almon) | (++)Greatly Improved Schedule adherence in both directions | (++)Greatly Improved Schedule adherence in both directions |
| | Public Consultation | (+)Seen by the public as not going far enough | (++)Overall seen as the best option by the public | (+)Seen as a good option by the public |
| | Score for Other Factors ¹ | 4 | 5 | 0 |
| Overall Evaluation | | 13 | 15 | 0 |

NOTES: 1. Score for other factors is the sum of the positive impacts less the negative impacts. Impacts with "++" or "--" receive double score.

While median transit lanes can offer significant benefits and are being considered by several jurisdictions nationwide and globally, the expected benefit on Robie Street is limited. The traffic volumes at many of the intersections along Robie Street can be categorized with low right turning volumes and high left turning volumes from Robie Street. Where the left turning volumes are substantial, the time required in the traffic signal phasing to provide protected-only left turn movements is found to limit the benefits of the median transit lanes, and the generally low right turning volume has only a small impediment to the progression of transit vehicles from the curbside lanes.

Attachment A

Comparative evaluation of the user impacts (Table 5-10), evaluation summary matrix (Table 5-10) and payback analysis (Table 5-11) indicate significant benefits to transit are anticipated with all corridor options. While Median Transit Lanes are expected to significantly improve the visibility of transit, their implementation on Robie Street is estimated to provide reduced benefits for transit compared to the curbside options and are expected to create negative impacts to non-transit vehicles (due to the high left turn volumes and the need for protected signal phasing). These non-transit impacts may worsen transit progression along the side streets (i.e. Spring Garden Road), and for these reasons, Option R2 (Curbside Transit Lanes on Robie Street) is recommended.

If HRM chooses to implement Option R1 then it should be considered an interim option while the additional property (Almon to Cunard) is acquired. With its added advantages for transit and consistency along the corridor in the southbound direction, Option R2 should ultimately be considered for implementation by HRM.

Given the similar benefits to transit and the higher property and tree impacts, higher implementation costs, longer pedestrian crossings, and negative traffic impacts with median transit lanes, **it is recommended that HRM select corridor option R2 Curbside Transit Lanes (Both Directions Full Corridor) for implementation.** HRM could consider the implementation of R1 as an interim option.

All transit options considered are expected to offer higher than projected benefits if:

- Consideration is given to restricting left turns at several intersections (however this would have severe implications on adjacent corridors);
- If Halifax Transit anticipates future implementation of LRT along the corridor; or,
- If consideration is given to expansion to 3 non-transit through lanes and / or dual left turn lanes at several intersections.

There may be benefit to preserving the corridor (as redevelopment progresses) to accommodate future implementation of median transit lanes if higher order transit is

Attachment A

This Space Intentionally Left Blank

6 SUMMARY & RECOMMENDATIONS

6.1 SUMMARY

Recent and ongoing policy development efforts have made improvements to Halifax's transit service a key priority for the Municipality. Specifically, Halifax Transit's *Moving Forward Together Plan* (adopted by Regional Council in April 2016) includes bold moves that will aim to improve transit service levels through increased priority, enhanced reliability, and reduced travel time. The bold moves are being made in support of the following four Council-endorsed '*Moving Forward Principles*':

1. Increase the proportion of resources allocated towards high ridership services.
2. Build a simplified transfer based system.
3. Invest in service quality and reliability.
4. Give transit increased priority in the transportation network.

Among the key initiatives that the Municipality is considering for transit upgrades are Transit Priority Measures (TPMs) – strategically located street and intersection upgrades that provide priority for the movement of buses. These measures have further been identified as action items in the Council approved *Integrated Mobility Plan* (IMP) with corridor level transit priority recommended for **Robie Street** and **Young Street**, which taken with the Regional Council approved transit priority on Bayers Road will provide a continuous transit corridor between Highway 102 and south end Halifax.

To address the identified need for transit priority along Robie and Young Streets, options were developed and evaluated against the level of impact that they are expected to have on transit operation as well as on active transportation (AT), general traffic, parking, road safety, and implementation cost.

Following initial development of the options for each corridor, consultation was held to gather input from key stakeholders through several meetings as well as from the overall public through an open house and online consultation on the project's Shape Your City website.

Options preparation included a significant data collection phase that included topographic survey, as well as obtaining and reviewing data on transit vehicle and ridership volumes, volumes of traffic, pedestrians, and bicycle, as well as consideration of public and stakeholder input. Analysis was completed to evaluate the identified options using criteria developed through discussion with HRM staff as well as the methodology presented in Appendix E of *Moving Forward Together* (Halifax Transit, 2016).

6.2 RECOMMENDATIONS

Based on the background review, public and stakeholder consultation, functional design, various analysis frameworks, and comparative analysis, the recommendations have been developed for consideration by HRM.

Consideration was given to the phasing of corridor improvements. A proposed implementation plan has been identified with recommendations presented as Priority A, B, or C where items in Priority 'A' should generally be considered during the earlier years of the Action Plan, with those in Priority 'C' considered in the later years.

6.2.1 RECOMMENDATIONS - YOUNG STREET

1. HRM should plan for the installation of Option Y3 (Continuous transit lanes – full corridor) along the entire corridor between Windsor Street and Robie Street.

PRIORITY 'A'

- Design modifications to implement Option Y3 (Continuous transit lanes – full corridor). Initiate acquisition of identified properties to implement this option.
- HRM should facilitate negotiations with abutting property owners and seek opportunities to provide access management along this corridor with consolidated access and traffic signalization at the Monaghan Drive intersection.

PRIORITY 'B'

- Implement Option Y3 between Windsor Street and Kempt Road (Option Y2).

PRIORITY 'C'

- Implement remainder of Option Y3 between Kempt Road and Robie Street.

6.2.2 RECOMMENDATIONS – ROBIE STREET

Segment 1 – Young Street to Almon Street:

1. HRM should plan for the installation of curbside transit lanes in each direction (Option R2, Option 1 in this segment). It is expected that this option can be implemented with limited property impacts.

Segment 2 – Almon Street to Cunard Street:

2. HRM should plan for the installation of curbside transit lanes in each direction (Option R2, Option 2 in this segment).
 - a. Given the property impacts associated with necessary widening HRM may wish to use a phased approach and implement Option 1 (curbside transit lanes, northbound only Cunard to Almon) initially with future plans to widen and provide the southbound transit lane through this segment as property becomes available.

Segment 3 – Cunard Street to Spring Garden Road:

3. HRM should plan for the installation of curbside transit lanes in each direction (Option R2, Option 1 in this segment).

Segment 4 – Spring Garden Road to Inglis Street:

4. HRM should plan for the installation of curbside transit lanes in each direction (Option R2, Option 1 in this segment).

PRIORITY ‘A’

- Complete an analysis of parking utilization on adjacent streets to understand the impact to parking and consider options to offset parking loss.
- Design modifications to implement corridor Option R-2 (Curbside transit lanes, both directions, full corridor). Initiate acquisition of identified properties to implement this option and / or identify desired right-of-way lines to accommodate this option as properties redevelop.
- Implement modifications for continuous transit lanes in both directions for Young Street to Almon Street.
- Design and implement modifications for Option 1 for the segment (northbound transit lane) between Almon Street and Cunard Street.

PRIORITY ‘B’

- Implement Option 1 (Curbside transit lanes) for the segment between Cunard Street and Spring Garden Road / Coburg Road.
- Implement Option 2 (Curbside transit lanes both directions) for the segment between Almon Street and Cunard Street when property is available.
- Implement Option 1 (Curbside transit lanes) for the segment between Spring Garden Road and South Street.

PRIORITY ‘C’

- Implement Option 1 (Curbside transit lanes) for the segment between South Street and Inglis Street.

6.3 CONCLUSION

Curbside transit lanes in both directions along the full corridor (Options Y3 on Young Street and R2 on Robie Street) are expected to provide significant benefit to Halifax Transit and, when combined with the Regional Council approved transit priority on Bayers Road will provide continuous transit lanes between Highway 102 and south end Halifax. While these benefits are projected to be significant using existing routing and ridership, any increase in transit vehicle frequency expected along this corridor or increased transit ridership will result in additional benefits beyond what is projected with this study.

APPENDIX

D

COST ESTIMATES



Attachment A

Attachment A

APPENDIX

E

METHODOLOGY
FOR DELAY AND
PAYBACK
CALCULATIONS

Attachment A

Attachment A

Using the Net User Delay Methodology developed in the *Transit Priority Measures Study* (WSP, 2016) as well the Transit ridership data and delay estimates obtained for each location it is possible to calculate the net road user delay during the subject peak hour as well as the payback periods associated with each measure. These equations are included below.

$$\text{Net Change in Road User Delay} = \text{Net Transit User Delay} + \text{Net Non Transit User Delay}$$

Where:

$$\text{Net Change in Transit User Delay} = \text{Delay/Transit Vehicle} \times \# \text{ Transit Vehicles} \times \text{Average Ridership per Transit Vehicle}$$

And,

$$\text{Net Change in Non Transit User Delay} = \text{Delay/Non Transit Vehicle} \times \# \text{ Non Transit Vehicles} \times \text{Average Vehicle Occupancy}$$

Note: Delay reductions will be a negative value while delay increases will be a positive value.

$$\text{Daily Change in Cost to Transit}$$

$$= \text{Average Change in Delay/Transit Vehicle} \times \# \text{ Transit Vehicles} \times \text{Cost/hour for Transit Vehicle}$$

$$\text{Annual Change in Cost to Transit} = \text{Daily Change in Cost to Transit} \times \text{Days/Year TPM is in Use}$$

$$\text{Daily Change in Cost to Public} = \text{Daily Change in Person Cost} + \text{Daily Change in nonTransit Vehicle Cost}$$

Where

$$\text{Daily Change in Person Cost}$$

$$= \text{Net Change in Road User Delay} \times \# \text{ hours TPM will be in effect per day} \times \text{Cost/hour for Road User}$$

$$\text{Daily Change in nonTransit Vehicle Cost}$$

$$= \text{Average delay change per nonTransit user} \times \# \text{ of NonTransit vehicles} \times \text{Cost /hour for nonTransit Vehicle}$$

$$\text{Annual Change in Cost to Public} = \text{Daily Change in Cost to Public} \times \text{Days/Year TPM is in Use}$$

$$\text{Payback Period} = \frac{\text{TPM Capital Cost}}{\text{Annual Cost Savings to Transit} + \text{Annual Cost Savings to Public} - \text{Annual Change in Operating Cost}}$$

Attachment A

APPENDIX

F

YOUNG STREET
INTERSECTION
CAPACITY
ANALYSIS

Attachment A

Attachment A

Table F-1 - Young Street AM Peak Hour Intersection Analysis

| Intersection | | AM Peak Hour | | | | | | | | | | | | |
|----------------|-------|------------------------|-----------------------|-------|------|-----|-------|---|-----------------------|-------|------|------|-------|-----|
| | | Existing Conditions | | | | | | Preferred Option | | | | | | |
| | | Scenario | Approach ¹ | Delay | V/C | LOS | Queue | Option | Approach ¹ | Delay | V/C | LOS | Queue | |
| Young Street @ | Kempt | Existing (Page F-2) | EB-L | 16.7 | 0.15 | B | 9.9 | High Invest ² (Page F-6) | EB-L | 21.8 | 0.21 | C | 12.4 | |
| | | | EB-TR | 23.5 | 0.55 | C | 53.2 | | EB-T | 24.3 | 0.49 | C | 58.3 | |
| | | | WB-LTR | 30.9 | 0.78 | C | 33.4 | | EB-R | 7.8 | 0.15 | A | 11.3 | |
| | | | NB-LTR | 14.0 | 0.29 | B | 29.9 | | WB-L | 17.4 | 0.24 | B | 5.0 | |
| | | | SB-L | 17.2 | 0.29 | B | 28.3 | | WB-T | 21.1 | 0.60 | C | 27.9 | |
| | | | SB-TR | 9.3 | 0.20 | A | 19.1 | | WB-R | 2.1 | 0.18 | A | 0.0 | |
| | Robie | Existing (Page F-3) | EB-L | 14.4 | 0.41 | B | 11.6 | Medium Invest ³ (Page F-7) | EB-L | 27.0 | 0.39 | C | 26.7 | |
| | | | EB-T | 24.8 | 0.79 | C | 109.2 | | EB-T | 23.9 | 0.75 | C | 61.9 | |
| | | | EB-R | 4.1 | 0.25 | A | 3.9 | | EB-R | 2.0 | 0.22 | A | 0.9 | |
| | | | WB-L | 20.5 | 0.13 | C | 5.6 | | WB-L | 40.2 | 0.15 | D | 11.6 | |
| | | | WB-TR | 41.2 | 0.79 | D | 95.5 | | WB-TR | 84.3 | 0.96 | F | 121.9 | |
| | | | NB-L | 28.7 | 0.53 | C | 19.5 | | NB-L | 20.8 | 0.46 | C | 19.3 | |
| | | | NB-TR | 18.0 | 0.40 | B | 37.3 | | NB-TR | 15.0 | 0.33 | B | 47.0 | |
| | | | SB-L | 17.8 | 0.24 | B | 16.3 | | SB-L | 22.5 | 0.21 | C | 19.8 | |
| | | | SB-TR | 21.0 | 0.67 | C | 85.5 | | SB-T | 66.0 | 1.01 | E | 256.1 | |
| | | | | | | | | | | SB-R | 4.5 | 0.13 | A | 9.1 |

Notes:

- Young Street is east/west for the full corridor
- Installation of eastbound and westbound right turn (except buses) lanes at Kempt intersection.
- Installation of eastbound and southbound right turn (except buses) lanes at Robie intersection. Modifications to eastbound right turn channel for bus-only.

Table F-2 - Young Street PM Peak Hour Intersection Analysis

| Intersection | | PM Peak Hour | | | | | | | | | | | | |
|----------------|-------|------------------------|-----------------------|-------|------|------|-------|---|-----------------------|-------|------|------|-------|------|
| | | Existing Conditions | | | | | | Preferred Option | | | | | | |
| | | Scenario | Approach ¹ | Delay | V/C | LOS | Queue | Option | Approach ¹ | Delay | V/C | LOS | Queue | |
| Young Street @ | Kempt | Existing (Page F-4) | EB-L | 30.4 | 0.69 | C | 36.2 | High Invest ² (Page F-8) | EB-L | 26.0 | 0.59 | C | 54.6 | |
| | | | EB-TR | 19.0 | 0.60 | B | 60.6 | | EB-T | 13.3 | 0.30 | B | 38.5 | |
| | | | WB-LTR | 51.0 | 0.88 | D | 44.7 | | EB-R | 2.9 | 0.28 | A | 11.9 | |
| | | | NB-LTR | 21.4 | 0.45 | C | 45.5 | | WB-L | 6.8 | 0.06 | A | 1.3 | |
| | | | SB-L | 27.2 | 0.58 | C | 56.1 | | WB-T | 11.8 | 0.52 | B | 25.6 | |
| | | | SB-TR | 8.5 | 0.26 | A | 19.5 | | WB-R | 1.4 | 0.20 | A | 0.0 | |
| | Robie | Existing (Page F-5) | EB-L | 25.3 | 0.66 | C | 33.5 | Medium Invest ³ (Page F-9) | EB-L | 48.3 | 0.62 | D | 34.2 | |
| | | | EB-T | 17.3 | 0.50 | B | 45.3 | | NB-TR | 35.4 | 0.36 | D | 27.9 | |
| | | | EB-R | 4.1 | 0.33 | A | 8.5 | | SB-L | 24.7 | 0.52 | C | 45.0 | |
| | | | WB-L | 24.6 | 0.07 | C | 7.1 | | SB-TR | 23.4 | 0.32 | C | 35.0 | |
| | | | WB-TR | 63.9 | 0.95 | E | 140.5 | | EB-L | 31.8 | 0.64 | C | 41.0 | |
| | | | NB-L | 25.6 | 0.77 | C | 13.8 | | EB-T | 18.6 | 0.48 | B | 48.2 | |
| | | | NB-TR | 14.3 | 0.81 | B | 36.7 | | EB-R | 4.7 | 0.24 | A | 13.7 | |
| | | | SB-L | 32.6 | 0.40 | C | 15.0 | | WB-L | 25.2 | 0.06 | C | 7.2 | |
| | | | SB-TR | 20.4 | 0.49 | C | 48.3 | | WB-TR | 56.1 | 0.90 | E | 134.3 | |
| | | | | | | | | | | NB-L | 25.9 | 0.66 | C | 32.2 |
| | | | | | | | | | | NB-TR | 22.7 | 0.65 | C | 85.3 |
| | | | | | | | | | | SB-L | 30.7 | 0.28 | C | 14.3 |
| | | | | | | SB-T | 60.2 | 0.94 | E | 135.9 | | | | |
| | | | | | | SB-R | 3.4 | 0.17 | A | 6.3 | | | | |

Notes:

- Young Street is east/west for the full corridor
- Installation of eastbound and westbound right turn (except buses) lanes at Kempt intersection.
- Installation of eastbound and southbound right turn (except buses) lanes at Robie intersection. Modifications to eastbound right turn channel for bus-only.

| Lane Group | EBL | EBT | EBR | WBL | WBT | WBR | NBL | NBT | NBR | SBL | SBT | SBR |
|------------------------|-------|------|-----|------|--------|-----|------|-------|-----|-------|-------|-----|
| Lane Configurations | | | | | | | | | | | | |
| Traffic Volume (vph) | 35 | 450 | 55 | 45 | 305 | 70 | 60 | 55 | 45 | 125 | 70 | 60 |
| Future Volume (vph) | 35 | 450 | 55 | 45 | 305 | 70 | 60 | 55 | 45 | 125 | 70 | 60 |
| Satd. Flow (prot) | 1371 | 2776 | 0 | 0 | 2837 | 0 | 0 | 1485 | 0 | 1456 | 1422 | 0 |
| Flt Permitted | 0.329 | | | | 0.815 | | | 0.843 | | 0.664 | | |
| Satd. Flow (perm) | 457 | 2776 | 0 | 0 | 2318 | 0 | 0 | 1267 | 0 | 1003 | 1422 | 0 |
| Satd. Flow (RTOR) | | 17 | | | 25 | | | 29 | | 63 | | |
| Lane Group Flow (vph) | 40 | 577 | 0 | 0 | 479 | 0 | 0 | 182 | 0 | 143 | 148 | 0 |
| Turn Type | pm+pt | NA | | Perm | NA | | Perm | NA | | Perm | NA | |
| Protected Phases | 3 | 8 | | | 4 | | | 6 | | | 2 | |
| Permitted Phases | 8 | | | 4 | | | 6 | | | 2 | | |
| Total Split (s) | 13.0 | 42.0 | | 29.0 | 29.0 | | 48.0 | 48.0 | | 48.0 | 48.0 | |
| Total Lost Time (s) | 4.0 | 6.4 | | | 6.4 | | | 6.4 | | 6.4 | 6.4 | |
| Act Effct Green (s) | 36.0 | 33.6 | | | 23.2 | | | 43.6 | | 43.6 | 43.6 | |
| Actuated g/C Ratio | 0.40 | 0.37 | | | 0.26 | | | 0.48 | | 0.48 | 0.48 | |
| v/c Ratio | 0.15 | 0.55 | | | 0.78 | | | 0.29 | | 0.29 | 0.20 | |
| Control Delay | 16.7 | 23.4 | | | 28.6 | | | 14.0 | | 17.2 | 9.3 | |
| Queue Delay | 0.0 | 0.1 | | | 2.4 | | | 0.0 | | 0.0 | 0.0 | |
| Total Delay | 16.7 | 23.5 | | | 30.9 | | | 14.0 | | 17.2 | 9.3 | |
| LOS | B | C | | | C | | | B | | B | A | |
| Approach Delay | | 23.0 | | | 30.9 | | | 14.0 | | | 13.2 | |
| Approach LOS | | C | | | C | | | B | | | B | |
| Queue Length 50th (m) | 3.8 | 36.3 | | | 18.5 | | | 16.4 | | 15.7 | 8.5 | |
| Queue Length 95th (m) | 9.9 | 53.2 | | | m#33.4 | | | 29.9 | | 28.3 | 19.1 | |
| Internal Link Dist (m) | | 97.3 | | | 50.7 | | | 102.8 | | | 408.6 | |
| Turn Bay Length (m) | | | | | | | | | | 30.0 | | |
| Base Capacity (vph) | 274 | 1121 | | | 616 | | | 635 | | 491 | 728 | |
| Starvation Cap Reductn | 0 | 0 | | | 57 | | | 0 | | 0 | 0 | |
| Spillback Cap Reductn | 0 | 68 | | | 0 | | | 0 | | 0 | 0 | |
| Storage Cap Reductn | 0 | 0 | | | 0 | | | 0 | | 0 | 0 | |
| Reduced v/c Ratio | 0.15 | 0.55 | | | 0.86 | | | 0.29 | | 0.29 | 0.20 | |

Intersection Summary

Cycle Length: 90
 Actuated Cycle Length: 90
 Offset: 50 (56%), Referenced to phase 2:SBTL and 6:NBTL, Start of Green
 Control Type: Actuated-Coordinated
 Maximum v/c Ratio: 0.79
 Intersection Signal Delay: 22.6
 Intersection Capacity Utilization 94.7%
 Analysis Period (min) 15
 Intersection LOS: C
 ICU Level of Service F

95th percentile volume exceeds capacity, queue may be longer.
 Queue shown is maximum after two cycles.
 m Volume for 95th percentile queue is metered by upstream signal.

Splits and Phases: 2: Young & Kempt

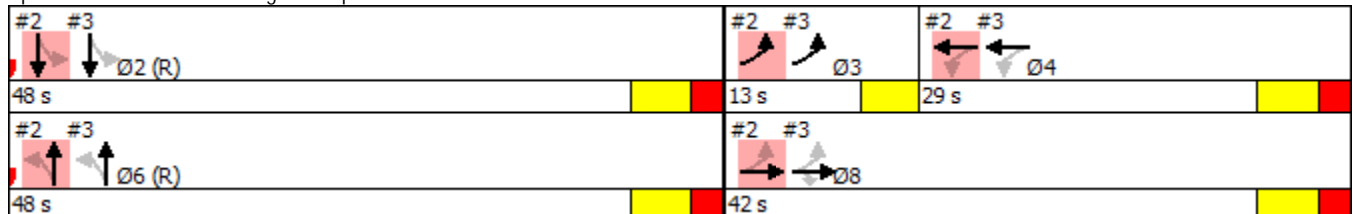

| Lane Group | EBL | EBT | EBR | WBL | WBT | WBR | NBL | NBT | NBR | SBL | SBT | SBR |
|------------------------|-------|-------|------|-------|-------|-----|--------|-------|-----|-------|-------|-----|
| Lane Configurations | | | | | | | | | | | | |
| Traffic Volume (vph) | 100 | 405 | 115 | 20 | 260 | 20 | 80 | 495 | 20 | 60 | 735 | 80 |
| Future Volume (vph) | 100 | 405 | 115 | 20 | 260 | 20 | 80 | 495 | 20 | 60 | 735 | 80 |
| Satd. Flow (prot) | 1439 | 1568 | 1348 | 1507 | 1559 | 0 | 1507 | 2990 | 0 | 1439 | 2861 | 0 |
| Flt Permitted | 0.316 | | | 0.460 | | | 0.227 | | | 0.396 | | |
| Satd. Flow (perm) | 463 | 1568 | 1238 | 702 | 1559 | 0 | 359 | 2990 | 0 | 595 | 2861 | 0 |
| Satd. Flow (RTOR) | | | 92 | | 4 | | | 6 | | | 17 | |
| Lane Group Flow (vph) | 114 | 462 | 131 | 23 | 320 | 0 | 91 | 588 | 0 | 68 | 930 | 0 |
| Turn Type | pm+pt | NA | Perm | Perm | NA | | Perm | NA | | Perm | NA | |
| Protected Phases | 3 | 8 | | | 4 | | | 6 | | | 2 | |
| Permitted Phases | 8 | | 8 | 4 | | | 6 | | | 2 | | |
| Total Split (s) | 13.0 | 42.0 | 42.0 | 29.0 | 29.0 | | 48.0 | 48.0 | | 48.0 | 48.0 | |
| Total Lost Time (s) | 4.0 | 6.4 | 6.4 | 6.4 | 6.4 | | 6.4 | 6.4 | | 6.4 | 6.4 | |
| Act Effct Green (s) | 36.0 | 33.6 | 33.6 | 23.2 | 23.2 | | 43.6 | 43.6 | | 43.6 | 43.6 | |
| Actuated g/C Ratio | 0.40 | 0.37 | 0.37 | 0.26 | 0.26 | | 0.48 | 0.48 | | 0.48 | 0.48 | |
| v/c Ratio | 0.41 | 0.79 | 0.25 | 0.13 | 0.79 | | 0.53 | 0.40 | | 0.24 | 0.67 | |
| Control Delay | 14.3 | 24.8 | 3.7 | 20.5 | 41.2 | | 28.7 | 18.0 | | 17.8 | 21.0 | |
| Queue Delay | 0.2 | 0.0 | 0.4 | 0.0 | 0.0 | | 0.0 | 0.0 | | 0.0 | 0.0 | |
| Total Delay | 14.4 | 24.8 | 4.1 | 20.5 | 41.2 | | 28.7 | 18.0 | | 17.8 | 21.0 | |
| LOS | B | C | A | C | D | | C | B | | B | C | |
| Approach Delay | | 19.3 | | | 39.8 | | | 19.5 | | | 20.8 | |
| Approach LOS | | B | | | D | | | B | | | C | |
| Queue Length 50th (m) | 6.3 | 28.5 | 0.9 | 1.7 | 52.3 | | 8.5 | 27.0 | | 7.2 | 66.6 | |
| Queue Length 95th (m) | 11.6 | 109.2 | 3.9 | m5.6 | #95.5 | | m#19.5 | 37.3 | | 16.3 | 85.5 | |
| Internal Link Dist (m) | | 50.7 | | | 118.4 | | | 360.9 | | | 410.5 | |
| Turn Bay Length (m) | 50.0 | | | | | | 140.0 | | | 70.0 | | |
| Base Capacity (vph) | 282 | 627 | 550 | 181 | 405 | | 175 | 1466 | | 291 | 1409 | |
| Starvation Cap Reductn | 13 | 0 | 169 | 0 | 0 | | 0 | 0 | | 0 | 0 | |
| Spillback Cap Reductn | 0 | 0 | 0 | 0 | 0 | | 0 | 0 | | 0 | 0 | |
| Storage Cap Reductn | 0 | 0 | 0 | 0 | 0 | | 0 | 0 | | 0 | 0 | |
| Reduced v/c Ratio | 0.42 | 0.74 | 0.34 | 0.13 | 0.79 | | 0.52 | 0.40 | | 0.23 | 0.66 | |

Intersection Summary

Cycle Length: 90
 Actuated Cycle Length: 90
 Offset: 50 (56%), Referenced to phase 2:SBTL and 6:NBTL, Start of Green
 Control Type: Actuated-Coordinated
 Maximum v/c Ratio: 0.79
 Intersection Signal Delay: 22.5
 Intersection Capacity Utilization 90.0%
 Analysis Period (min) 15
 Intersection LOS: C
 ICU Level of Service E

95th percentile volume exceeds capacity, queue may be longer.
 Queue shown is maximum after two cycles.
 m Volume for 95th percentile queue is metered by upstream signal.

Splits and Phases: 3: Robie & Young

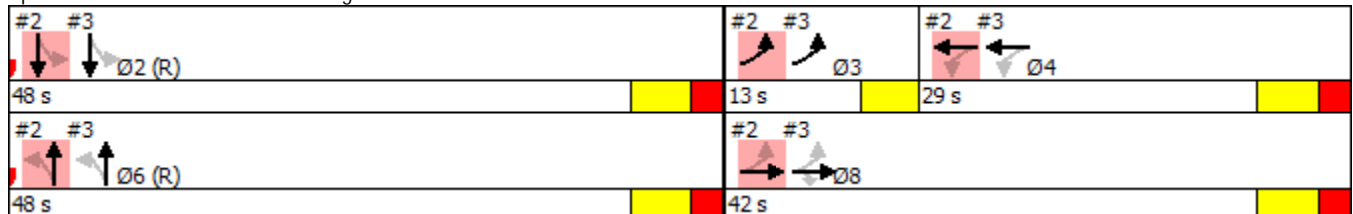

| Lane Group | EBL | EBT | EBR | WBL | WBT | WBR | NBL | NBT | NBR | SBL | SBT | SBR |
|------------------------|-------|------|-----|------|-------|-----|------|-------|-----|-------|-------|-----|
| Lane Configurations | | | | | | | | | | | | |
| Traffic Volume (vph) | 160 | 450 | 200 | 20 | 445 | 115 | 105 | 65 | 25 | 210 | 60 | 90 |
| Future Volume (vph) | 160 | 450 | 200 | 20 | 445 | 115 | 105 | 65 | 25 | 210 | 60 | 90 |
| Satd. Flow (prot) | 1411 | 2699 | 0 | 0 | 2857 | 0 | 0 | 1555 | 0 | 1498 | 1413 | 0 |
| Flt Permitted | 0.242 | | | | 0.905 | | | 0.742 | | 0.625 | | |
| Satd. Flow (perm) | 342 | 2699 | 0 | 0 | 2588 | 0 | 0 | 1168 | 0 | 974 | 1413 | 0 |
| Satd. Flow (RTOR) | | 100 | | | 34 | | | 10 | | | 103 | |
| Lane Group Flow (vph) | 183 | 742 | 0 | 0 | 662 | 0 | 0 | 223 | 0 | 240 | 171 | 0 |
| Turn Type | pm+pt | NA | | Perm | NA | | Perm | NA | | Perm | NA | |
| Protected Phases | 3 | 8 | | | 4 | | | 6 | | | 2 | |
| Permitted Phases | 8 | | | 4 | | | 6 | | | 2 | | |
| Total Split (s) | 14.0 | 46.0 | | 32.0 | 32.0 | | 44.0 | 44.0 | | 44.0 | 44.0 | |
| Total Lost Time (s) | 4.0 | 6.4 | | | 6.4 | | | 6.4 | | 6.4 | 6.4 | |
| Act Effct Green (s) | 43.8 | 41.4 | | | 27.6 | | | 35.8 | | 35.8 | 35.8 | |
| Actuated g/C Ratio | 0.49 | 0.46 | | | 0.31 | | | 0.40 | | 0.40 | 0.40 | |
| v/c Ratio | 0.65 | 0.57 | | | 0.81 | | | 0.47 | | 0.62 | 0.27 | |
| Control Delay | 26.8 | 17.8 | | | 29.6 | | | 22.6 | | 29.3 | 8.6 | |
| Queue Delay | 0.0 | 0.1 | | | 9.9 | | | 0.0 | | 0.0 | 0.0 | |
| Total Delay | 26.8 | 17.8 | | | 39.5 | | | 22.6 | | 29.3 | 8.6 | |
| LOS | C | B | | | D | | | C | | C | A | |
| Approach Delay | | 19.6 | | | 39.5 | | | 22.6 | | | 20.7 | |
| Approach LOS | | B | | | D | | | C | | | C | |
| Queue Length 50th (m) | 18.6 | 42.8 | | | 34.0 | | | 25.7 | | 31.2 | 7.0 | |
| Queue Length 95th (m) | #35.5 | 60.6 | | | m39.1 | | | 45.5 | | 56.2 | 19.5 | |
| Internal Link Dist (m) | | 97.3 | | | 50.7 | | | 38.9 | | | 145.1 | |
| Turn Bay Length (m) | | | | | | | | | | 30.0 | | |
| Base Capacity (vph) | 286 | 1294 | | | 817 | | | 493 | | 406 | 650 | |
| Starvation Cap Reductn | 0 | 0 | | | 133 | | | 0 | | 0 | 0 | |
| Spillback Cap Reductn | 0 | 33 | | | 0 | | | 0 | | 0 | 0 | |
| Storage Cap Reductn | 0 | 0 | | | 0 | | | 0 | | 0 | 0 | |
| Reduced v/c Ratio | 0.64 | 0.59 | | | 0.97 | | | 0.45 | | 0.59 | 0.26 | |

Intersection Summary

Cycle Length: 90
 Actuated Cycle Length: 90
 Offset: 56 (62%), Referenced to phase 2:SBTL and 6:NBTL, Start of Green
 Control Type: Actuated-Coordinated
 Maximum v/c Ratio: 0.95
 Intersection Signal Delay: 26.0
 Intersection Capacity Utilization 103.3%
 Analysis Period (min) 15
 # 95th percentile volume exceeds capacity, queue may be longer.
 Queue shown is maximum after two cycles.
 m Volume for 95th percentile queue is metered by upstream signal.

Splits and Phases: 2: Young & Kempt

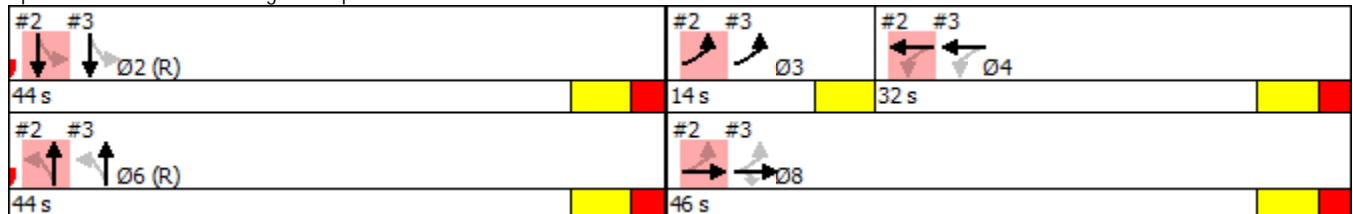

| Lane Group | EBL | EBT | EBR | WBL | WBT | WBR | NBL | NBT | NBR | SBL | SBT | SBR |
|------------------------|-------|------|------|-------|--------|-----|-------|-------|-----|-------|-------|-----|
| Lane Configurations | | | | | | | | | | | | |
| Traffic Volume (vph) | 160 | 325 | 200 | 15 | 340 | 60 | 165 | 850 | 15 | 35 | 420 | 75 |
| Future Volume (vph) | 160 | 325 | 200 | 15 | 340 | 60 | 165 | 850 | 15 | 35 | 420 | 75 |
| Satd. Flow (prot) | 1467 | 1598 | 1374 | 1536 | 1545 | 0 | 1536 | 3060 | 0 | 1467 | 2880 | 0 |
| Flt Permitted | 0.204 | | | 0.541 | | | 0.387 | | | 0.164 | | |
| Satd. Flow (perm) | 302 | 1598 | 1242 | 830 | 1545 | 0 | 617 | 3060 | 0 | 252 | 2880 | 0 |
| Satd. Flow (RTOR) | | | 204 | | 10 | | | 2 | | | 28 | |
| Lane Group Flow (vph) | 183 | 371 | 228 | 17 | 456 | 0 | 188 | 987 | 0 | 40 | 565 | 0 |
| Turn Type | pm+pt | NA | Perm | Perm | NA | | Perm | NA | | Perm | NA | |
| Protected Phases | 3 | 8 | | | 4 | | | 6 | | | 2 | |
| Permitted Phases | 8 | | 8 | 4 | | | 6 | | | 2 | | |
| Total Split (s) | 14.0 | 46.0 | 46.0 | 32.0 | 32.0 | | 44.0 | 44.0 | | 44.0 | 44.0 | |
| Total Lost Time (s) | 4.0 | 6.4 | 6.4 | 6.4 | 6.4 | | 6.4 | 6.4 | | 6.4 | 6.4 | |
| Act Effct Green (s) | 43.8 | 41.4 | 41.4 | 27.6 | 27.6 | | 35.8 | 35.8 | | 35.8 | 35.8 | |
| Actuated g/C Ratio | 0.49 | 0.46 | 0.46 | 0.31 | 0.31 | | 0.40 | 0.40 | | 0.40 | 0.40 | |
| v/c Ratio | 0.67 | 0.51 | 0.34 | 0.07 | 0.95 | | 0.77 | 0.81 | | 0.40 | 0.49 | |
| Control Delay | 26.6 | 15.8 | 3.6 | 24.6 | 63.1 | | 25.6 | 14.2 | | 32.6 | 20.4 | |
| Queue Delay | 0.0 | 1.5 | 0.5 | 0.0 | 0.0 | | 0.0 | 0.0 | | 0.0 | 0.0 | |
| Total Delay | 26.6 | 17.3 | 4.1 | 24.6 | 63.1 | | 25.6 | 14.2 | | 32.6 | 20.4 | |
| LOS | C | B | A | C | E | | C | B | | C | C | |
| Approach Delay | | 15.6 | | | 61.7 | | | 16.0 | | | 21.2 | |
| Approach LOS | | B | | | E | | | B | | | C | |
| Queue Length 50th (m) | 14.1 | 30.4 | 3.8 | 2.1 | -80.5 | | 9.6 | 26.5 | | 4.7 | 34.2 | |
| Queue Length 95th (m) | #34.8 | 45.3 | 8.5 | 7.1 | #140.5 | | m13.8 | m36.7 | | 15.0 | 48.3 | |
| Internal Link Dist (m) | | 50.7 | | | 216.3 | | | 360.9 | | | 146.5 | |
| Turn Bay Length (m) | 50.0 | | | | | | 140.0 | | | 70.0 | | |
| Base Capacity (vph) | 278 | 734 | 680 | 255 | 481 | | 257 | 1279 | | 105 | 1219 | |
| Starvation Cap Reductn | 0 | 198 | 178 | 0 | 0 | | 0 | 0 | | 0 | 0 | |
| Spillback Cap Reductn | 0 | 0 | 0 | 0 | 0 | | 0 | 0 | | 0 | 0 | |
| Storage Cap Reductn | 0 | 0 | 0 | 0 | 0 | | 0 | 0 | | 0 | 0 | |
| Reduced v/c Ratio | 0.66 | 0.69 | 0.45 | 0.07 | 0.95 | | 0.73 | 0.77 | | 0.38 | 0.46 | |

Intersection Summary

Cycle Length: 90
 Actuated Cycle Length: 90
 Offset: 56 (62%), Referenced to phase 2:SBTL and 6:NBTL, Start of Green
 Control Type: Actuated-Coordinated
 Maximum v/c Ratio: 0.95
 Intersection Signal Delay: 24.1
 Intersection Capacity Utilization 92.4%
 Analysis Period (min) 15
 ~ Volume exceeds capacity, queue is theoretically infinite.
 Queue shown is maximum after two cycles.
 # 95th percentile volume exceeds capacity, queue may be longer.
 Queue shown is maximum after two cycles.
 m Volume for 95th percentile queue is metered by upstream signal.

Splits and Phases: 3: Robie & Young

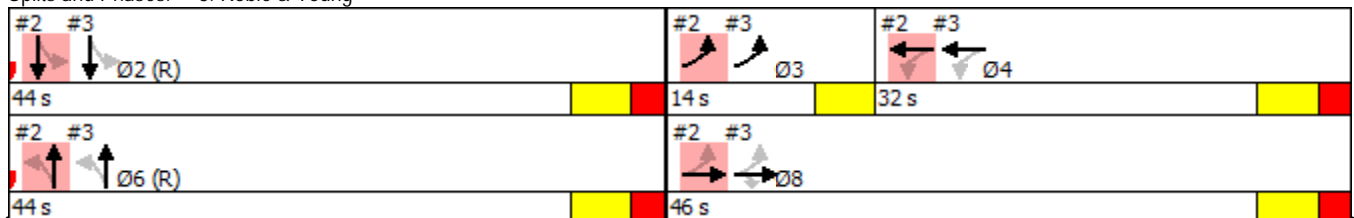

| Lane Group | EBL | EBT | EBR | WBL | WBT | WBR | NBL2 | NBT | SBL2 | SBT |
|------------------------|-------|-------|-------|-------|-------|-------|-------|-------|-------|-------|
| Lane Configurations | | | | | | | | | | |
| Traffic Volume (vph) | 35 | 442 | 8 | 45 | 299 | 6 | 60 | 55 | 125 | 70 |
| Future Volume (vph) | 35 | 442 | 8 | 45 | 299 | 6 | 60 | 55 | 125 | 70 |
| Lane Group Flow (vph) | 40 | 504 | 72 | 51 | 341 | 87 | 68 | 114 | 143 | 148 |
| Turn Type | Perm | NA | Perm | Perm | NA | Perm | Perm | NA | pm+pt | NA |
| Protected Phases | | 8 | | | 4 | | | 6 | 5 | 2 |
| Permitted Phases | 8 | | 8 | 4 | | 4 | 6 | | 2 | |
| Detector Phase | 8 | 8 | 8 | 4 | 4 | 4 | 6 | 6 | 5 | 2 |
| Switch Phase | | | | | | | | | | |
| Minimum Initial (s) | 10.0 | 10.0 | 10.0 | 10.0 | 10.0 | 10.0 | 10.0 | 10.0 | 8.0 | 10.0 |
| Minimum Split (s) | 27.4 | 27.4 | 27.4 | 27.4 | 27.4 | 27.4 | 29.4 | 29.4 | 13.0 | 29.4 |
| Total Split (s) | 51.0 | 51.0 | 51.0 | 51.0 | 51.0 | 51.0 | 30.0 | 30.0 | 29.0 | 59.0 |
| Total Split (%) | 46.4% | 46.4% | 46.4% | 46.4% | 46.4% | 46.4% | 27.3% | 27.3% | 26.4% | 53.6% |
| Yellow Time (s) | 4.1 | 4.1 | 4.1 | 4.1 | 4.1 | 4.1 | 4.1 | 4.1 | 3.0 | 4.1 |
| All-Red Time (s) | 2.3 | 2.3 | 2.3 | 2.3 | 2.3 | 2.3 | 2.3 | 2.3 | 0.0 | 2.3 |
| Lost Time Adjust (s) | 0.0 | 0.0 | 0.0 | 0.0 | 0.0 | 0.0 | 0.0 | 0.0 | 0.0 | 0.0 |
| Total Lost Time (s) | 6.4 | 6.4 | 6.4 | 6.4 | 6.4 | 6.4 | 6.4 | 6.4 | 3.0 | 6.4 |
| Lead/Lag | | | | | | | Lag | Lag | Lead | |
| Lead-Lag Optimize? | | | | | | | | | | |
| Recall Mode | C-Min | C-Min | C-Min | C-Min | C-Min | C-Min | Min | Min | Max | Min |
| Act Effct Green (s) | 35.5 | 35.5 | 35.5 | 35.5 | 35.5 | 35.5 | 13.4 | 13.4 | 65.1 | 61.7 |
| Actuated g/C Ratio | 0.32 | 0.32 | 0.32 | 0.32 | 0.32 | 0.32 | 0.12 | 0.12 | 0.59 | 0.56 |
| v/c Ratio | 0.21 | 0.49 | 0.15 | 0.24 | 0.60 | 0.18 | 0.49 | 0.57 | 0.17 | 0.17 |
| Control Delay | 21.8 | 24.3 | 7.8 | 17.4 | 20.0 | 2.1 | 56.4 | 56.5 | 11.4 | 13.1 |
| Queue Delay | 0.0 | 0.0 | 0.0 | 0.0 | 1.1 | 0.0 | 0.0 | 0.3 | 0.0 | 0.0 |
| Total Delay | 21.8 | 24.3 | 7.8 | 17.4 | 21.1 | 2.1 | 56.4 | 56.9 | 11.4 | 13.1 |
| LOS | C | C | A | B | C | A | E | E | B | B |
| Approach Delay | | 22.3 | | | 17.3 | | | 56.7 | | 12.3 |
| Approach LOS | | C | | | B | | | E | | B |
| Queue Length 50th (m) | 6.7 | 48.2 | 4.8 | 3.8 | 26.1 | 0.0 | 13.9 | 23.6 | 13.0 | 14.8 |
| Queue Length 95th (m) | m12.4 | 58.3 | m11.3 | m5.0 | m27.9 | m0.0 | 26.8 | 39.7 | 24.7 | 27.6 |
| Internal Link Dist (m) | | 97.3 | | | 50.7 | | | 38.9 | | 145.1 |
| Turn Bay Length (m) | 45.0 | | | 12.0 | | | | | 30.0 | |
| Base Capacity (vph) | 236 | 1288 | 598 | 266 | 710 | 580 | 243 | 349 | 837 | 879 |
| Starvation Cap Reductn | 0 | 0 | 0 | 0 | 181 | 0 | 0 | 0 | 0 | 0 |
| Spillback Cap Reductn | 0 | 0 | 0 | 0 | 0 | 0 | 0 | 46 | 79 | 0 |
| Storage Cap Reductn | 0 | 0 | 0 | 0 | 0 | 0 | 0 | 0 | 0 | 0 |
| Reduced v/c Ratio | 0.17 | 0.39 | 0.12 | 0.19 | 0.64 | 0.15 | 0.28 | 0.38 | 0.19 | 0.17 |

Intersection Summary

Cycle Length: 110
 Actuated Cycle Length: 110
 Offset: 16 (15%), Referenced to phase 4:WBTL and 8:EBTL, Start of Green
 Natural Cycle: 70
 Control Type: Actuated-Coordinated
 Maximum v/c Ratio: 0.60
 Intersection Signal Delay: 22.9
 Intersection Capacity Utilization 68.6%
 Analysis Period (min) 15
 m Volume for 95th percentile queue is metered by upstream signal.

Intersection LOS: C
 ICU Level of Service C

Splits and Phases: 2: Young & Kempt

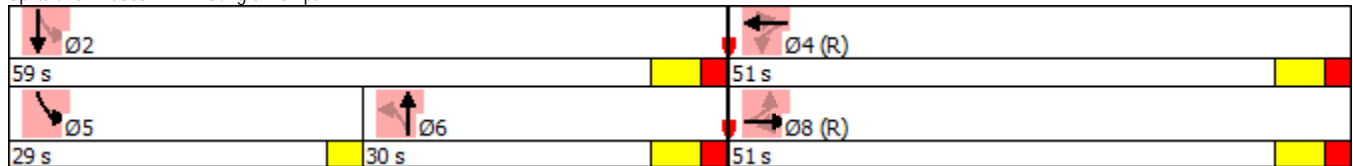

| Lane Group | EBL | EBT | EBR | WBL | WBT | NBL | NBT | SBL | SBT | SBR |
|------------------------|-------|-------|-------|-------|--------|-------|-------|-------|--------|-------|
| Lane Configurations | | | | | | | | | | |
| Traffic Volume (vph) | 100 | 405 | 107 | 20 | 260 | 80 | 495 | 60 | 731 | 80 |
| Future Volume (vph) | 100 | 405 | 107 | 20 | 260 | 80 | 495 | 60 | 731 | 80 |
| Lane Group Flow (vph) | 114 | 462 | 122 | 23 | 320 | 91 | 588 | 68 | 769 | 91 |
| Turn Type | pm+pt | NA | Perm | Perm | NA | pm+pt | NA | Perm | NA | Perm |
| Protected Phases | 3 | 8 | | | 4 | 1 | 6 | | 2 | |
| Permitted Phases | 8 | | 8 | 4 | | 6 | | 2 | | 2 |
| Detector Phase | 3 | 8 | 8 | 4 | 4 | 1 | 6 | 2 | 2 | 2 |
| Switch Phase | | | | | | | | | | |
| Minimum Initial (s) | 8.0 | 10.0 | 10.0 | 10.0 | 10.0 | 8.0 | 10.0 | 10.0 | 10.0 | 10.0 |
| Minimum Split (s) | 13.0 | 27.4 | 27.4 | 27.4 | 27.4 | 13.0 | 29.4 | 29.4 | 29.4 | 29.4 |
| Total Split (s) | 17.6 | 45.0 | 45.0 | 27.4 | 27.4 | 13.0 | 65.0 | 52.0 | 52.0 | 52.0 |
| Total Split (%) | 16.0% | 40.9% | 40.9% | 24.9% | 24.9% | 11.8% | 59.1% | 47.3% | 47.3% | 47.3% |
| Yellow Time (s) | 3.0 | 4.1 | 4.1 | 4.1 | 4.1 | 3.0 | 4.1 | 4.1 | 4.1 | 4.1 |
| All-Red Time (s) | 0.0 | 2.3 | 2.3 | 2.3 | 2.3 | 0.0 | 2.3 | 2.3 | 2.3 | 2.3 |
| Lost Time Adjust (s) | 0.0 | 0.0 | 0.0 | 0.0 | 0.0 | 0.0 | 0.0 | 0.0 | 0.0 | 0.0 |
| Total Lost Time (s) | 3.0 | 6.4 | 6.4 | 6.4 | 6.4 | 3.0 | 6.4 | 6.4 | 6.4 | 6.4 |
| Lead/Lag | Lead | | | Lag | Lag | | | | | |
| Lead-Lag Optimize? | | | | | | | | | | |
| Recall Mode | C-Max | C-Min | C-Min | Min | Min | None | Min | Min | Min | Min |
| Act Effct Green (s) | 42.0 | 38.6 | 38.6 | 21.0 | 21.0 | 62.0 | 58.6 | 49.1 | 49.1 | 49.1 |
| Actuated g/C Ratio | 0.38 | 0.35 | 0.35 | 0.19 | 0.19 | 0.56 | 0.53 | 0.45 | 0.45 | 0.45 |
| v/c Ratio | 0.39 | 0.75 | 0.22 | 0.15 | 0.96 | 0.46 | 0.33 | 0.21 | 1.01 | 0.13 |
| Control Delay | 26.8 | 23.0 | 1.5 | 40.2 | 84.3 | 20.8 | 15.0 | 22.5 | 66.0 | 4.5 |
| Queue Delay | 0.2 | 0.9 | 0.4 | 0.0 | 0.0 | 0.0 | 0.0 | 0.0 | 0.0 | 0.0 |
| Total Delay | 27.0 | 23.9 | 2.0 | 40.2 | 84.3 | 20.8 | 15.0 | 22.5 | 66.0 | 4.5 |
| LOS | C | C | A | D | F | C | B | C | E | A |
| Approach Delay | | 20.6 | | | 81.4 | | 15.8 | | 56.8 | |
| Approach LOS | | C | | | F | | B | | E | |
| Queue Length 50th (m) | 5.8 | 31.1 | 0.1 | 4.2 | 68.0 | 8.6 | 35.5 | 9.0 | -179.1 | 0.0 |
| Queue Length 95th (m) | 26.7 | 61.9 | 0.9 | 11.6 | #121.9 | 19.3 | 47.0 | 19.8 | #256.1 | 9.1 |
| Internal Link Dist (m) | | 50.7 | | | 218.5 | | 360.9 | | 375.2 | |
| Turn Bay Length (m) | 25.0 | | | | | 140.0 | | 70.0 | | 60.0 |
| Base Capacity (vph) | 291 | 615 | 556 | 149 | 334 | 217 | 1783 | 321 | 765 | 705 |
| Starvation Cap Reductn | 17 | 34 | 185 | 0 | 0 | 0 | 0 | 0 | 0 | 0 |
| Spillback Cap Reductn | 0 | 0 | 0 | 0 | 0 | 0 | 0 | 0 | 0 | 0 |
| Storage Cap Reductn | 0 | 0 | 0 | 0 | 0 | 0 | 0 | 0 | 0 | 0 |
| Reduced v/c Ratio | 0.42 | 0.80 | 0.33 | 0.15 | 0.96 | 0.42 | 0.33 | 0.21 | 1.01 | 0.13 |

Intersection Summary

Cycle Length: 110
 Actuated Cycle Length: 110
 Offset: 108 (98%), Referenced to phase 3:EBL and 8:EBTL, Start of Green
 Natural Cycle: 105
 Control Type: Actuated-Coordinated
 Maximum v/c Ratio: 1.01
 Intersection Signal Delay: 39.9
 Intersection Capacity Utilization 95.2%
 Analysis Period (min) 15
 ~ Volume exceeds capacity, queue is theoretically infinite.
 Queue shown is maximum after two cycles.
 # 95th percentile volume exceeds capacity, queue may be longer.
 Queue shown is maximum after two cycles.

Splits and Phases: 3: Robie & Young

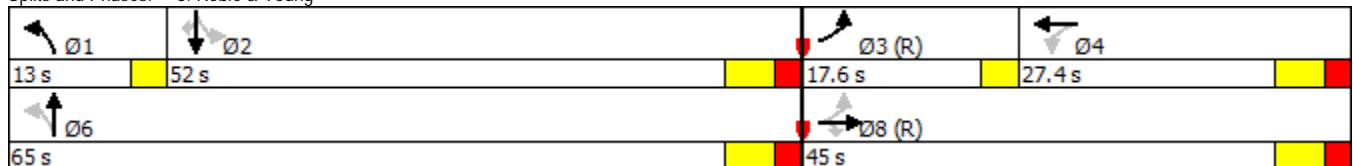

| Lane Group | EBL | EBT | EBR | WBL | WBT | WBR | NBL2 | NBT | SBL2 | SBT |
|------------------------|-------|-------|-------|-------|-------|-------|-------|-------|-------|-------|
| Lane Configurations | | | | | | | | | | |
| Traffic Volume (vph) | 160 | 446 | 4 | 20 | 432 | 13 | 105 | 65 | 210 | 60 |
| Future Volume (vph) | 160 | 446 | 4 | 20 | 432 | 13 | 105 | 65 | 210 | 60 |
| Lane Group Flow (vph) | 183 | 509 | 233 | 23 | 493 | 146 | 120 | 103 | 240 | 171 |
| Turn Type | Perm | NA | Perm | Perm | NA | Perm | Perm | NA | pm+pt | NA |
| Protected Phases | | 8 | | | 4 | | | 6 | 5 | 2 |
| Permitted Phases | 8 | | 8 | 4 | | 4 | 6 | | 2 | |
| Detector Phase | 8 | 8 | 8 | 4 | 4 | 4 | 6 | 6 | 5 | 2 |
| Switch Phase | | | | | | | | | | |
| Minimum Initial (s) | 10.0 | 10.0 | 10.0 | 10.0 | 10.0 | 10.0 | 10.0 | 10.0 | 8.0 | 10.0 |
| Minimum Split (s) | 27.4 | 27.4 | 27.4 | 27.4 | 27.4 | 27.4 | 29.4 | 29.4 | 13.0 | 29.4 |
| Total Split (s) | 47.0 | 47.0 | 47.0 | 47.0 | 47.0 | 47.0 | 30.0 | 30.0 | 13.0 | 43.0 |
| Total Split (%) | 52.2% | 52.2% | 52.2% | 52.2% | 52.2% | 52.2% | 33.3% | 33.3% | 14.4% | 47.8% |
| Yellow Time (s) | 4.1 | 4.1 | 4.1 | 4.1 | 4.1 | 4.1 | 4.1 | 4.1 | 3.0 | 4.1 |
| All-Red Time (s) | 2.3 | 2.3 | 2.3 | 2.3 | 2.3 | 2.3 | 2.3 | 2.3 | 0.0 | 2.3 |
| Lost Time Adjust (s) | 0.0 | 0.0 | 0.0 | 0.0 | 0.0 | 0.0 | 0.0 | 0.0 | 0.0 | 0.0 |
| Total Lost Time (s) | 6.4 | 6.4 | 6.4 | 6.4 | 6.4 | 6.4 | 6.4 | 6.4 | 3.0 | 6.4 |
| Lead/Lag | | | | | | | Lag | Lag | Lead | |
| Lead-Lag Optimize? | | | | | | | | | | |
| Recall Mode | C-Min | C-Min | C-Min | C-Min | C-Min | C-Min | Min | Min | None | Min |
| Act Effect Green (s) | 47.0 | 47.0 | 47.0 | 47.0 | 47.0 | 47.0 | 15.0 | 15.0 | 33.6 | 30.2 |
| Actuated g/C Ratio | 0.52 | 0.52 | 0.52 | 0.52 | 0.52 | 0.52 | 0.17 | 0.17 | 0.37 | 0.34 |
| v/c Ratio | 0.59 | 0.30 | 0.28 | 0.06 | 0.52 | 0.20 | 0.62 | 0.36 | 0.52 | 0.32 |
| Control Delay | 26.0 | 13.3 | 2.9 | 6.8 | 9.4 | 0.9 | 48.3 | 35.3 | 24.5 | 23.4 |
| Queue Delay | 0.0 | 0.0 | 0.0 | 0.0 | 2.5 | 0.5 | 0.0 | 0.1 | 0.2 | 0.0 |
| Total Delay | 26.0 | 13.3 | 2.9 | 6.8 | 11.8 | 1.4 | 48.3 | 35.4 | 24.7 | 23.4 |
| LOS | C | B | A | A | B | A | D | D | C | C |
| Approach Delay | | 13.2 | | | 9.4 | | | 42.4 | | 24.2 |
| Approach LOS | | B | | | A | | | D | | C |
| Queue Length 50th (m) | 21.9 | 26.2 | 0.4 | 1.1 | 23.9 | 0.0 | 19.6 | 16.0 | 28.6 | 21.0 |
| Queue Length 95th (m) | #54.6 | 38.5 | 11.9 | m1.3 | m25.6 | m0.0 | 34.2 | 27.9 | 45.0 | 35.0 |
| Internal Link Dist (m) | | 97.3 | | | 50.7 | | | 38.9 | | 145.1 |
| Turn Bay Length (m) | 45.0 | | | 12.0 | | | | | 30.0 | |
| Base Capacity (vph) | 310 | 1708 | 831 | 413 | 942 | 719 | 302 | 454 | 464 | 642 |
| Starvation Cap Reductn | 0 | 0 | 0 | 0 | 317 | 308 | 0 | 0 | 0 | 0 |
| Spillback Cap Reductn | 0 | 0 | 0 | 0 | 0 | 0 | 0 | 42 | 24 | 0 |
| Storage Cap Reductn | 0 | 0 | 0 | 0 | 0 | 0 | 0 | 0 | 0 | 0 |
| Reduced v/c Ratio | 0.59 | 0.30 | 0.28 | 0.06 | 0.79 | 0.36 | 0.40 | 0.25 | 0.55 | 0.27 |

Intersection Summary

Cycle Length: 90
 Actuated Cycle Length: 90
 Offset: 4 (4%), Referenced to phase 4:WBTL and 8:EBTL, Start of Green
 Natural Cycle: 80
 Control Type: Actuated-Coordinated
 Maximum v/c Ratio: 0.63
 Intersection Signal Delay: 17.0
 Intersection Capacity Utilization 78.7%
 Analysis Period (min) 15
 # 95th percentile volume exceeds capacity, queue may be longer.
 Queue shown is maximum after two cycles.
 m Volume for 95th percentile queue is metered by upstream signal.

Splits and Phases: 2: Young Street & Kempt

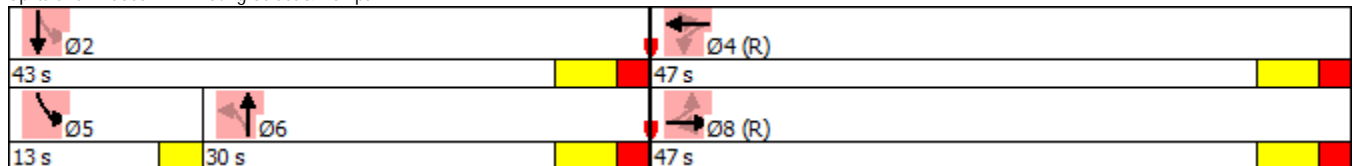

| Lane Group | EBL | EBT | EBR | WBL | WBT | NBL | NBT | SBL | SBT | SBR |
|------------------------|-------|-------|--------|-------|--------|-------|-------|-------|--------|-------|
| Lane Configurations | | | | | | | | | | |
| Traffic Volume (vph) | 160 | 325 | 191 | 15 | 340 | 165 | 850 | 35 | 416 | 75 |
| Future Volume (vph) | 160 | 325 | 191 | 15 | 340 | 165 | 850 | 35 | 416 | 75 |
| Lane Group Flow (vph) | 183 | 371 | 218 | 17 | 456 | 188 | 956 | 40 | 475 | 86 |
| Turn Type | pm+pt | NA | custom | Perm | NA | pm+pt | NA | Perm | NA | Perm |
| Protected Phases | 3 | 8 | | | 4 | 1 | 6 | | 2 | |
| Permitted Phases | 8 | | 1 8 | 4 | | 6 | | 2 | | 2 |
| Detector Phase | 3 | 8 | 1 8 | 4 | 4 | 1 | 6 | 2 | 2 | 2 |
| Switch Phase | | | | | | | | | | |
| Minimum Initial (s) | 8.0 | 10.0 | | 10.0 | 10.0 | 7.0 | 10.0 | 10.0 | 10.0 | 10.0 |
| Minimum Split (s) | 13.0 | 27.4 | | 27.4 | 27.4 | 11.0 | 29.4 | 29.4 | 29.4 | 29.4 |
| Total Split (s) | 13.0 | 44.0 | | 31.0 | 31.0 | 13.0 | 46.0 | 33.0 | 33.0 | 33.0 |
| Total Split (%) | 14.4% | 48.9% | | 34.4% | 34.4% | 14.4% | 51.1% | 36.7% | 36.7% | 36.7% |
| Yellow Time (s) | 3.0 | 4.1 | | 4.1 | 4.1 | 3.0 | 4.1 | 4.1 | 4.1 | 4.1 |
| All-Red Time (s) | 0.0 | 2.3 | | 2.3 | 2.3 | 0.0 | 2.3 | 2.3 | 2.3 | 2.3 |
| Lost Time Adjust (s) | 0.0 | 0.0 | | 0.0 | 0.0 | 0.0 | 0.0 | 0.0 | 0.0 | 0.0 |
| Total Lost Time (s) | 3.0 | 6.4 | | 6.4 | 6.4 | 3.0 | 6.4 | 6.4 | 6.4 | 6.4 |
| Lead/Lag | Lead | | | Lag | Lag | | | | | |
| Lead-Lag Optimize? | | | | | | | | | | |
| Recall Mode | None | C-Min | | C-Min | C-Min | None | Min | Min | Min | Min |
| Act Effct Green (s) | 42.0 | 38.6 | 54.5 | 26.0 | 26.0 | 42.0 | 38.6 | 26.1 | 26.1 | 26.1 |
| Actuated g/C Ratio | 0.47 | 0.43 | 0.61 | 0.29 | 0.29 | 0.47 | 0.43 | 0.29 | 0.29 | 0.29 |
| v/c Ratio | 0.64 | 0.48 | 0.24 | 0.06 | 0.90 | 0.66 | 0.65 | 0.28 | 0.94 | 0.17 |
| Control Delay | 31.7 | 16.5 | 4.2 | 25.2 | 54.5 | 25.9 | 22.7 | 30.7 | 60.2 | 3.4 |
| Queue Delay | 0.2 | 2.1 | 0.5 | 0.0 | 1.6 | 0.0 | 0.0 | 0.0 | 0.0 | 0.0 |
| Total Delay | 31.8 | 18.6 | 4.7 | 25.2 | 56.1 | 25.9 | 22.7 | 30.7 | 60.2 | 3.4 |
| LOS | C | B | A | C | E | C | C | C | E | A |
| Approach Delay | | 17.8 | | | 54.9 | | 23.2 | | 50.1 | |
| Approach LOS | | B | | | D | | C | | D | |
| Queue Length 50th (m) | 15.6 | 33.1 | 3.2 | 2.2 | 75.9 | 18.3 | 65.3 | 5.3 | 79.1 | 0.0 |
| Queue Length 95th (m) | #41.0 | 48.2 | 13.7 | 7.2 | #134.3 | #32.2 | 85.3 | 14.3 | #135.9 | 6.3 |
| Internal Link Dist (m) | | 50.7 | | | 218.5 | | 360.9 | | 255.1 | |
| Turn Bay Length (m) | 25.0 | | | 15.0 | | 140.0 | | 70.0 | | 60.0 |
| Base Capacity (vph) | 289 | 766 | 931 | 267 | 506 | 294 | 1505 | 145 | 517 | 515 |
| Starvation Cap Reductn | 4 | 254 | 389 | 0 | 0 | 0 | 0 | 0 | 0 | 0 |
| Spillback Cap Reductn | 0 | 0 | 0 | 0 | 10 | 0 | 0 | 0 | 0 | 0 |
| Storage Cap Reductn | 0 | 0 | 0 | 0 | 0 | 0 | 0 | 0 | 0 | 0 |
| Reduced v/c Ratio | 0.64 | 0.72 | 0.40 | 0.06 | 0.92 | 0.64 | 0.64 | 0.28 | 0.92 | 0.17 |

Intersection Summary

Cycle Length: 90
 Actuated Cycle Length: 90
 Offset: 0 (0%), Referenced to phase 4:WBTL and 8:EBTL, Start of Green, Master Intersection
 Natural Cycle: 85
 Control Type: Actuated-Coordinated
 Maximum v/c Ratio: 0.94
 Intersection Signal Delay: 32.2
 Intersection Capacity Utilization 85.7%
 Analysis Period (min) 15
 # 95th percentile volume exceeds capacity, queue may be longer.
 Queue shown is maximum after two cycles.

Splits and Phases: 3: Robie & Young Street

| | | | |
|------|------|------|------|
| | | | |
| 13 s | 33 s | 13 s | 31 s |
| | | | |
| 46 s | | 44 s | |

| Lane Group | EBL | EBT | WBL | WBT | WBR | NBL2 | NBT | SBL | SBT |
|------------------------|-------|-------|-------|-------|-------|-------|-------|-------|-------|
| Lane Configurations | | | | | | | | | |
| Traffic Volume (vph) | 35 | 450 | 45 | 299 | 6 | 60 | 55 | 125 | 70 |
| Future Volume (vph) | 35 | 450 | 45 | 299 | 6 | 60 | 55 | 125 | 70 |
| Lane Group Flow (vph) | 40 | 577 | 51 | 341 | 87 | 68 | 114 | 143 | 148 |
| Turn Type | Perm | NA | Perm | NA | Perm | Perm | NA | pm+pt | NA |
| Protected Phases | | 8 | | 4 | | | 6 | 5 | 2 |
| Permitted Phases | 8 | | 4 | | 4 | 6 | | 2 | |
| Detector Phase | 8 | 8 | 4 | 4 | 4 | 6 | 6 | 5 | 2 |
| Switch Phase | | | | | | | | | |
| Minimum Initial (s) | 10.0 | 10.0 | 10.0 | 10.0 | 10.0 | 10.0 | 10.0 | 8.0 | 10.0 |
| Minimum Split (s) | 27.4 | 27.4 | 27.4 | 27.4 | 27.4 | 29.4 | 29.4 | 13.0 | 29.4 |
| Total Split (s) | 51.0 | 51.0 | 51.0 | 51.0 | 51.0 | 30.0 | 30.0 | 29.0 | 59.0 |
| Total Split (%) | 46.4% | 46.4% | 46.4% | 46.4% | 46.4% | 27.3% | 27.3% | 26.4% | 53.6% |
| Yellow Time (s) | 4.1 | 4.1 | 4.1 | 4.1 | 4.1 | 4.1 | 4.1 | 3.0 | 4.1 |
| All-Red Time (s) | 2.3 | 2.3 | 2.3 | 2.3 | 2.3 | 2.3 | 2.3 | 0.0 | 2.3 |
| Lost Time Adjust (s) | 0.0 | 0.0 | 0.0 | 0.0 | 0.0 | 0.0 | 0.0 | 0.0 | 0.0 |
| Total Lost Time (s) | 6.4 | 6.4 | 6.4 | 6.4 | 6.4 | 6.4 | 6.4 | 3.0 | 6.4 |
| Lead/Lag | | | | | | Lag | Lag | Lead | |
| Lead-Lag Optimize? | | | | | | | | | |
| Recall Mode | C-Min | C-Min | C-Min | C-Min | C-Min | None | None | Max | None |
| Act Effct Green (s) | 36.3 | 36.3 | 36.3 | 36.3 | 36.3 | 12.8 | 12.8 | 64.3 | 60.9 |
| Actuated g/C Ratio | 0.33 | 0.33 | 0.33 | 0.33 | 0.33 | 0.12 | 0.12 | 0.58 | 0.55 |
| v/c Ratio | 0.21 | 0.56 | 0.27 | 0.59 | 0.18 | 0.52 | 0.52 | 0.17 | 0.17 |
| Control Delay | 20.6 | 23.9 | 17.9 | 19.5 | 2.1 | 59.1 | 39.9 | 11.8 | 13.5 |
| Queue Delay | 0.0 | 0.0 | 0.0 | 1.3 | 0.0 | 0.0 | 0.2 | 0.0 | 0.0 |
| Total Delay | 20.6 | 23.9 | 17.9 | 20.8 | 2.1 | 59.1 | 40.2 | 11.8 | 13.5 |
| LOS | C | C | B | C | A | E | D | B | B |
| Approach Delay | | 23.7 | | 17.1 | | | 47.2 | | 12.7 |
| Approach LOS | | C | | B | | | D | | B |
| Queue Length 50th (m) | 6.6 | 54.3 | 3.8 | 26.1 | 0.0 | 14.1 | 16.4 | 13.3 | 15.1 |
| Queue Length 95th (m) | m12.3 | 64.8 | m5.1 | m28.2 | m0.0 | 27.0 | 32.4 | 24.9 | 27.8 |
| Internal Link Dist (m) | | 97.3 | | 50.7 | | | 38.9 | | 145.1 |
| Turn Bay Length (m) | 45.0 | | 12.0 | | | | | 30.0 | |
| Base Capacity (vph) | 240 | 1264 | 232 | 710 | 580 | 243 | 375 | 827 | 868 |
| Starvation Cap Reductn | 0 | 0 | 0 | 193 | 0 | 0 | 0 | 0 | 0 |
| Spillback Cap Reductn | 0 | 0 | 0 | 0 | 0 | 0 | 47 | 64 | 0 |
| Storage Cap Reductn | 0 | 0 | 0 | 0 | 0 | 0 | 0 | 0 | 0 |
| Reduced v/c Ratio | 0.17 | 0.46 | 0.22 | 0.66 | 0.15 | 0.28 | 0.35 | 0.19 | 0.17 |

Intersection Summary

Cycle Length: 110
 Actuated Cycle Length: 110
 Offset: 16 (15%), Referenced to phase 4:WBTL and 8:EBTL, Start of Green
 Natural Cycle: 70
 Control Type: Actuated-Coordinated
 Maximum v/c Ratio: 0.59
 Intersection Signal Delay: 22.4
 Intersection Capacity Utilization 74.7%
 Analysis Period (min) 15
 m Volume for 95th percentile queue is metered by upstream signal.

Intersection LOS: C
 ICU Level of Service D

Splits and Phases: 2: Young & Kempt

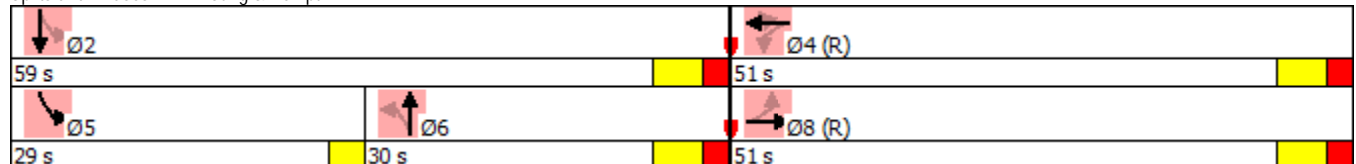

| Lane Group | EBL | EBT | EBR | WBL | WBT | NBL | NBT | SBL | SBT | SBR |
|------------------------|-------|-------|-------|-------|--------|-------|-------|-------|--------|-------|
| Lane Configurations | | | | | | | | | | |
| Traffic Volume (vph) | 100 | 405 | 115 | 20 | 260 | 80 | 495 | 60 | 731 | 80 |
| Future Volume (vph) | 100 | 405 | 115 | 20 | 260 | 80 | 495 | 60 | 731 | 80 |
| Lane Group Flow (vph) | 114 | 462 | 131 | 23 | 320 | 91 | 588 | 68 | 808 | 91 |
| Turn Type | pm+pt | NA | Perm | Perm | NA | pm+pt | NA | Perm | NA | Perm |
| Protected Phases | 3 | 8 | | | 4 | 1 | 6 | | 2 | |
| Permitted Phases | 8 | | 8 | 4 | | 6 | | 2 | | 2 |
| Detector Phase | 3 | 8 | | 4 | 4 | 1 | 6 | 2 | 2 | 2 |
| Switch Phase | | | | | | | | | | |
| Minimum Initial (s) | 8.0 | 10.0 | 10.0 | 10.0 | 10.0 | 8.0 | 10.0 | 10.0 | 10.0 | 10.0 |
| Minimum Split (s) | 13.0 | 27.4 | 27.4 | 27.4 | 27.4 | 13.0 | 29.4 | 29.4 | 29.4 | 29.4 |
| Total Split (s) | 17.6 | 45.0 | 45.0 | 27.4 | 27.4 | 13.0 | 65.0 | 52.0 | 52.0 | 52.0 |
| Total Split (%) | 16.0% | 40.9% | 40.9% | 24.9% | 24.9% | 11.8% | 59.1% | 47.3% | 47.3% | 47.3% |
| Yellow Time (s) | 3.0 | 4.1 | 4.1 | 4.1 | 4.1 | 3.0 | 4.1 | 4.1 | 4.1 | 4.1 |
| All-Red Time (s) | 0.0 | 2.3 | 2.3 | 2.3 | 2.3 | 0.0 | 2.3 | 2.3 | 2.3 | 2.3 |
| Lost Time Adjust (s) | 0.0 | 0.0 | 0.0 | 0.0 | 0.0 | 0.0 | 0.0 | 0.0 | 0.0 | 0.0 |
| Total Lost Time (s) | 3.0 | 6.4 | 6.4 | 6.4 | 6.4 | 3.0 | 6.4 | 6.4 | 6.4 | 6.4 |
| Lead/Lag | Lead | | | Lag | Lag | Lead | | Lag | Lag | Lag |
| Lead-Lag Optimize? | | | | | | | | | | |
| Recall Mode | C-Max | C-Min | C-Min | Min | Min | None | Min | Min | Min | Min |
| Act Effct Green (s) | 42.0 | 38.6 | 38.6 | 21.0 | 21.0 | 62.0 | 58.6 | 49.1 | 49.1 | 49.1 |
| Actuated g/C Ratio | 0.38 | 0.35 | 0.35 | 0.19 | 0.19 | 0.56 | 0.53 | 0.45 | 0.45 | 0.45 |
| v/c Ratio | 0.39 | 0.75 | 0.23 | 0.15 | 0.96 | 0.46 | 0.33 | 0.21 | 1.06 | 0.13 |
| Control Delay | 26.0 | 23.0 | 1.8 | 40.2 | 84.3 | 20.8 | 15.0 | 22.5 | 80.0 | 4.5 |
| Queue Delay | 0.2 | 0.6 | 0.5 | 0.0 | 0.0 | 0.0 | 0.0 | 0.0 | 0.0 | 0.0 |
| Total Delay | 26.2 | 23.6 | 2.2 | 40.2 | 84.3 | 20.8 | 15.0 | 22.5 | 80.0 | 4.5 |
| LOS | C | C | A | D | F | C | B | C | E | A |
| Approach Delay | | 20.0 | | | 81.4 | | 15.8 | | 68.8 | |
| Approach LOS | | C | | | F | | B | | E | |
| Queue Length 50th (m) | 6.3 | 32.3 | 0.1 | 4.2 | 68.0 | 8.6 | 35.5 | 9.0 | -196.6 | 0.0 |
| Queue Length 95th (m) | 26.6 | 59.1 | 1.2 | 11.6 | #121.9 | 19.3 | 47.0 | 19.8 | #274.5 | 9.1 |
| Internal Link Dist (m) | | 50.7 | | | 218.5 | | 360.9 | | 413.0 | |
| Turn Bay Length (m) | 25.0 | | | | | 140.0 | | 70.0 | | 60.0 |
| Base Capacity (vph) | 291 | 615 | 562 | 149 | 334 | 217 | 1783 | 321 | 765 | 705 |
| Starvation Cap Reductn | 17 | 25 | 184 | 0 | 0 | 0 | 0 | 0 | 0 | 0 |
| Spillback Cap Reductn | 0 | 0 | 0 | 0 | 0 | 0 | 0 | 0 | 0 | 0 |
| Storage Cap Reductn | 0 | 0 | 0 | 0 | 0 | 0 | 0 | 0 | 0 | 0 |
| Reduced v/c Ratio | 0.42 | 0.78 | 0.35 | 0.15 | 0.96 | 0.42 | 0.33 | 0.21 | 1.06 | 0.13 |

Intersection Summary

Cycle Length: 110
 Actuated Cycle Length: 110
 Offset: 108 (98%), Referenced to phase 3:EBL and 8:EBTL, Start of Green
 Natural Cycle: 115
 Control Type: Actuated-Coordinated
 Maximum v/c Ratio: 1.06
 Intersection Signal Delay: 44.3
 Intersection Capacity Utilization 97.1%
 Analysis Period (min) 15
 ~ Volume exceeds capacity, queue is theoretically infinite.
 Queue shown is maximum after two cycles.
 # 95th percentile volume exceeds capacity, queue may be longer.
 Queue shown is maximum after two cycles.

Splits and Phases: 3: Robie & Young

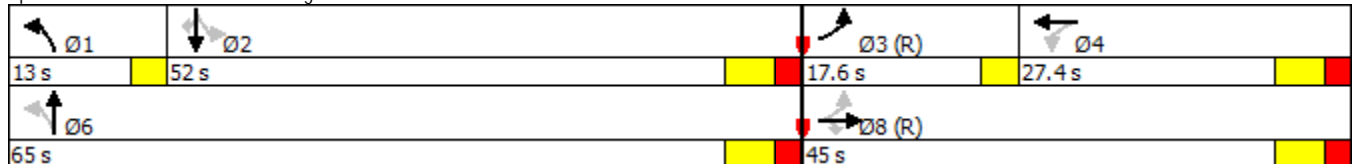

| Lane Group | EBL | EBT | WBL | WBT | WBR | NBL2 | NBT | SBL | SBT |
|------------------------|-------|-------|-------|-------|-------|-------|-------|-------|-------|
| Lane Configurations | | | | | | | | | |
| Traffic Volume (vph) | 160 | 450 | 20 | 432 | 13 | 105 | 65 | 210 | 60 |
| Future Volume (vph) | 160 | 450 | 20 | 432 | 13 | 105 | 65 | 210 | 60 |
| Lane Group Flow (vph) | 183 | 742 | 23 | 493 | 146 | 120 | 103 | 240 | 171 |
| Turn Type | Perm | NA | Perm | NA | Perm | Perm | NA | pm+pt | NA |
| Protected Phases | | 8 | | 4 | | | 6 | 5 | 2 |
| Permitted Phases | 8 | | 4 | | 4 | 6 | | 2 | |
| Detector Phase | 8 | 8 | 4 | 4 | 4 | 6 | 6 | 5 | 2 |
| Switch Phase | | | | | | | | | |
| Minimum Initial (s) | 10.0 | 10.0 | 10.0 | 10.0 | 10.0 | 10.0 | 10.0 | 8.0 | 10.0 |
| Minimum Split (s) | 27.4 | 27.4 | 27.4 | 27.4 | 27.4 | 29.4 | 29.4 | 13.0 | 29.4 |
| Total Split (s) | 47.0 | 47.0 | 47.0 | 47.0 | 47.0 | 30.0 | 30.0 | 13.0 | 43.0 |
| Total Split (%) | 52.2% | 52.2% | 52.2% | 52.2% | 52.2% | 33.3% | 33.3% | 14.4% | 47.8% |
| Yellow Time (s) | 4.1 | 4.1 | 4.1 | 4.1 | 4.1 | 4.1 | 4.1 | 3.0 | 4.1 |
| All-Red Time (s) | 2.3 | 2.3 | 2.3 | 2.3 | 2.3 | 2.3 | 2.3 | 0.0 | 2.3 |
| Lost Time Adjust (s) | 0.0 | 0.0 | 0.0 | 0.0 | 0.0 | 0.0 | 0.0 | 0.0 | 0.0 |
| Total Lost Time (s) | 6.4 | 6.4 | 6.4 | 6.4 | 6.4 | 6.4 | 6.4 | 3.0 | 6.4 |
| Lead/Lag | | | | | | Lag | Lag | Lead | |
| Lead-Lag Optimize? | | | | | | | | | |
| Recall Mode | C-Min | C-Min | C-Min | C-Min | C-Min | Min | Min | None | Min |
| Act Effct Green (s) | 47.0 | 47.0 | 47.0 | 47.0 | 47.0 | 15.0 | 15.0 | 33.6 | 30.2 |
| Actuated g/C Ratio | 0.52 | 0.52 | 0.52 | 0.52 | 0.52 | 0.17 | 0.17 | 0.37 | 0.34 |
| v/c Ratio | 0.59 | 0.46 | 0.08 | 0.52 | 0.20 | 0.62 | 0.34 | 0.52 | 0.32 |
| Control Delay | 26.0 | 13.0 | 7.0 | 9.4 | 0.9 | 48.3 | 27.8 | 24.5 | 23.4 |
| Queue Delay | 0.0 | 0.0 | 0.0 | 2.5 | 0.5 | 0.0 | 0.1 | 0.3 | 0.0 |
| Total Delay | 26.0 | 13.0 | 7.0 | 11.9 | 1.4 | 48.3 | 27.9 | 24.8 | 23.4 |
| LOS | C | B | A | B | A | D | C | C | C |
| Approach Delay | | 15.6 | | 9.4 | | | 38.9 | | 24.2 |
| Approach LOS | | B | | A | | | D | | C |
| Queue Length 50th (m) | 21.9 | 36.0 | 1.1 | 23.9 | 0.0 | 19.6 | 12.6 | 28.6 | 21.0 |
| Queue Length 95th (m) | #54.6 | 53.0 | m1.3 | m25.6 | m0.0 | 34.2 | 24.5 | 45.0 | 35.0 |
| Internal Link Dist (m) | | 97.3 | | 50.7 | | | 38.9 | | 145.1 |
| Turn Bay Length (m) | 45.0 | | 12.0 | | | | | 30.0 | |
| Base Capacity (vph) | 310 | 1624 | 302 | 942 | 719 | 302 | 469 | 464 | 642 |
| Starvation Cap Reductn | 0 | 0 | 0 | 317 | 308 | 0 | 0 | 0 | 0 |
| Spillback Cap Reductn | 0 | 3 | 0 | 0 | 0 | 0 | 54 | 31 | 0 |
| Storage Cap Reductn | 0 | 0 | 0 | 0 | 0 | 0 | 0 | 0 | 0 |
| Reduced v/c Ratio | 0.59 | 0.46 | 0.08 | 0.79 | 0.36 | 0.40 | 0.25 | 0.55 | 0.27 |

Intersection Summary

Cycle Length: 90
 Actuated Cycle Length: 90
 Offset: 4 (4%), Referenced to phase 4:WBTL and 8:EBTL, Start of Green
 Natural Cycle: 80
 Control Type: Actuated-Coordinated
 Maximum v/c Ratio: 0.63
 Intersection Signal Delay: 17.7
 Intersection Capacity Utilization 78.7%
 Analysis Period (min) 15
 # 95th percentile volume exceeds capacity, queue may be longer.
 Queue shown is maximum after two cycles.
 m Volume for 95th percentile queue is metered by upstream signal.

Splits and Phases: 2: Young Street & Kempt

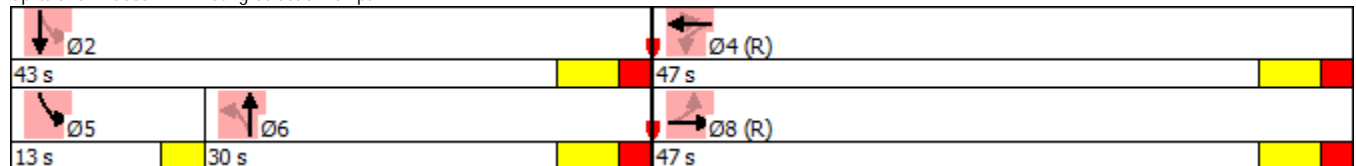

| Lane Group | EBL | EBT | EBR | WBL | WBT | NBL | NBT | SBL | SBT | SBR |
|------------------------|-------|-------|--------|-------|--------|-------|-------|-------|--------|-------|
| Lane Configurations | | | | | | | | | | |
| Traffic Volume (vph) | 160 | 325 | 200 | 15 | 340 | 165 | 850 | 35 | 416 | 75 |
| Future Volume (vph) | 160 | 325 | 200 | 15 | 340 | 165 | 850 | 35 | 416 | 75 |
| Lane Group Flow (vph) | 183 | 371 | 228 | 17 | 456 | 188 | 956 | 40 | 475 | 86 |
| Turn Type | pm+pt | NA | custom | Perm | NA | pm+pt | NA | Perm | NA | Perm |
| Protected Phases | 3 | 8 | | | 4 | 1 | 6 | | 2 | |
| Permitted Phases | 8 | | 1 8 | 4 | | 6 | | 2 | | 2 |
| Detector Phase | 3 | 8 | 1 8 | 4 | 4 | 1 | 6 | 2 | 2 | 2 |
| Switch Phase | | | | | | | | | | |
| Minimum Initial (s) | 8.0 | 10.0 | | 10.0 | 10.0 | 7.0 | 10.0 | 10.0 | 10.0 | 10.0 |
| Minimum Split (s) | 13.0 | 27.4 | | 27.4 | 27.4 | 11.0 | 29.4 | 29.4 | 29.4 | 29.4 |
| Total Split (s) | 13.0 | 44.0 | | 31.0 | 31.0 | 13.0 | 46.0 | 33.0 | 33.0 | 33.0 |
| Total Split (%) | 14.4% | 48.9% | | 34.4% | 34.4% | 14.4% | 51.1% | 36.7% | 36.7% | 36.7% |
| Yellow Time (s) | 3.0 | 4.1 | | 4.1 | 4.1 | 3.0 | 4.1 | 4.1 | 4.1 | 4.1 |
| All-Red Time (s) | 0.0 | 2.3 | | 2.3 | 2.3 | 0.0 | 2.3 | 2.3 | 2.3 | 2.3 |
| Lost Time Adjust (s) | 0.0 | 0.0 | | 0.0 | 0.0 | 0.0 | 0.0 | 0.0 | 0.0 | 0.0 |
| Total Lost Time (s) | 3.0 | 6.4 | | 6.4 | 6.4 | 3.0 | 6.4 | 6.4 | 6.4 | 6.4 |
| Lead/Lag | Lead | | | Lag | Lag | | | | | |
| Lead-Lag Optimize? | | | | | | | | | | |
| Recall Mode | None | C-Min | | C-Min | C-Min | None | Min | Min | Min | Min |
| Act Effct Green (s) | 42.0 | 38.6 | 54.5 | 26.0 | 26.0 | 42.0 | 38.6 | 26.1 | 26.1 | 26.1 |
| Actuated g/C Ratio | 0.47 | 0.43 | 0.61 | 0.29 | 0.29 | 0.47 | 0.43 | 0.29 | 0.29 | 0.29 |
| v/c Ratio | 0.64 | 0.48 | 0.25 | 0.06 | 0.90 | 0.66 | 0.65 | 0.28 | 0.94 | 0.17 |
| Control Delay | 29.2 | 17.7 | 4.6 | 25.2 | 54.5 | 25.9 | 22.7 | 30.7 | 60.2 | 3.4 |
| Queue Delay | 0.1 | 2.1 | 0.5 | 0.0 | 1.6 | 0.0 | 0.0 | 0.0 | 0.0 | 0.0 |
| Total Delay | 29.4 | 19.8 | 5.1 | 25.2 | 56.1 | 25.9 | 22.7 | 30.7 | 60.2 | 3.4 |
| LOS | C | B | A | C | E | C | C | C | E | A |
| Approach Delay | | 17.8 | | | 54.9 | | 23.2 | | 50.1 | |
| Approach LOS | | B | | | D | | C | | D | |
| Queue Length 50th (m) | 15.8 | 35.6 | 3.7 | 2.2 | 75.9 | 18.3 | 65.3 | 5.3 | 79.1 | 0.0 |
| Queue Length 95th (m) | #40.0 | 54.6 | 16.2 | 7.2 | #134.3 | #32.2 | 85.3 | 14.3 | #135.9 | 6.3 |
| Internal Link Dist (m) | | 50.7 | | | 218.5 | | 360.9 | | 255.1 | |
| Turn Bay Length (m) | 25.0 | | | 15.0 | | 140.0 | | 70.0 | | 60.0 |
| Base Capacity (vph) | 289 | 766 | 931 | 267 | 506 | 294 | 1505 | 145 | 517 | 515 |
| Starvation Cap Reductn | 3 | 257 | 380 | 0 | 0 | 0 | 0 | 0 | 0 | 0 |
| Spillback Cap Reductn | 0 | 0 | 0 | 0 | 10 | 0 | 0 | 0 | 0 | 0 |
| Storage Cap Reductn | 0 | 0 | 0 | 0 | 0 | 0 | 0 | 0 | 0 | 0 |
| Reduced v/c Ratio | 0.64 | 0.73 | 0.41 | 0.06 | 0.92 | 0.64 | 0.64 | 0.28 | 0.92 | 0.17 |

Intersection Summary

Cycle Length: 90
 Actuated Cycle Length: 90
 Offset: 0 (0%), Referenced to phase 4:WBTL and 8:EBTL, Start of Green, Master Intersection
 Natural Cycle: 85
 Control Type: Actuated-Coordinated
 Maximum v/c Ratio: 0.94
 Intersection Signal Delay: 32.2
 Intersection Capacity Utilization 85.7%
 Analysis Period (min) 15
 # 95th percentile volume exceeds capacity, queue may be longer.
 Queue shown is maximum after two cycles.

Splits and Phases: 3: Robie & Young Street

| | | | |
|------|------|------|------|
| | | | |
| 13 s | 33 s | 13 s | 31 s |
| | | | |
| 46 s | | 44 s | |

| Lane Group | EBL | EBT | WBL | WBT | WBR | NBL2 | NBT | SBL | SBT |
|------------------------|-------|-------|-------|-------|-------|-------|-------|-------|-------|
| Lane Configurations | | | | | | | | | |
| Traffic Volume (vph) | 35 | 450 | 45 | 299 | 6 | 60 | 55 | 125 | 70 |
| Future Volume (vph) | 35 | 450 | 45 | 299 | 6 | 60 | 55 | 125 | 70 |
| Lane Group Flow (vph) | 40 | 577 | 51 | 341 | 87 | 68 | 114 | 143 | 148 |
| Turn Type | Perm | NA | Perm | NA | Perm | Perm | NA | pm+pt | NA |
| Protected Phases | | 8 | | 4 | | | 6 | 5 | 2 |
| Permitted Phases | 8 | | 4 | | 4 | 6 | | 2 | |
| Detector Phase | 8 | 8 | 4 | 4 | 4 | 6 | 6 | 5 | 2 |
| Switch Phase | | | | | | | | | |
| Minimum Initial (s) | 10.0 | 10.0 | 10.0 | 10.0 | 10.0 | 10.0 | 10.0 | 8.0 | 10.0 |
| Minimum Split (s) | 27.4 | 27.4 | 27.4 | 27.4 | 27.4 | 29.4 | 29.4 | 13.0 | 29.4 |
| Total Split (s) | 51.0 | 51.0 | 51.0 | 51.0 | 51.0 | 30.0 | 30.0 | 29.0 | 59.0 |
| Total Split (%) | 46.4% | 46.4% | 46.4% | 46.4% | 46.4% | 27.3% | 27.3% | 26.4% | 53.6% |
| Yellow Time (s) | 4.1 | 4.1 | 4.1 | 4.1 | 4.1 | 4.1 | 4.1 | 3.0 | 4.1 |
| All-Red Time (s) | 2.3 | 2.3 | 2.3 | 2.3 | 2.3 | 2.3 | 2.3 | 0.0 | 2.3 |
| Lost Time Adjust (s) | 0.0 | 0.0 | 0.0 | 0.0 | 0.0 | 0.0 | 0.0 | 0.0 | 0.0 |
| Total Lost Time (s) | 6.4 | 6.4 | 6.4 | 6.4 | 6.4 | 6.4 | 6.4 | 3.0 | 6.4 |
| Lead/Lag | | | | | | Lag | Lag | Lead | |
| Lead-Lag Optimize? | | | | | | | | | |
| Recall Mode | C-Min | C-Min | C-Min | C-Min | C-Min | Min | Min | None | Min |
| Act Effct Green (s) | 67.1 | 67.1 | 67.1 | 67.1 | 67.1 | 12.8 | 12.8 | 33.5 | 30.1 |
| Actuated g/C Ratio | 0.61 | 0.61 | 0.61 | 0.61 | 0.61 | 0.12 | 0.12 | 0.30 | 0.27 |
| v/c Ratio | 0.08 | 0.30 | 0.12 | 0.32 | 0.10 | 0.52 | 0.52 | 0.39 | 0.35 |
| Control Delay | 20.8 | 22.1 | 14.3 | 15.8 | 5.9 | 59.1 | 39.9 | 30.7 | 32.7 |
| Queue Delay | 0.0 | 0.1 | 0.0 | 3.7 | 0.0 | 0.0 | 0.3 | 0.1 | 0.0 |
| Total Delay | 20.8 | 22.2 | 14.3 | 19.6 | 5.9 | 59.1 | 40.3 | 30.8 | 32.7 |
| LOS | C | C | B | B | A | E | D | C | C |
| Approach Delay | | 22.1 | | 16.5 | | | 47.3 | | 31.8 |
| Approach LOS | | C | | B | | | D | | C |
| Queue Length 50th (m) | 6.4 | 54.5 | 5.8 | 40.5 | 1.9 | 14.1 | 16.4 | 23.6 | 25.8 |
| Queue Length 95th (m) | m9.9 | m62.3 | m5.2 | m29.6 | m0.1 | 27.0 | 32.4 | 34.0 | 37.3 |
| Internal Link Dist (m) | | 97.3 | | 50.7 | | | 38.9 | | 145.1 |
| Turn Bay Length (m) | 45.0 | | 12.0 | | | | | 30.0 | |
| Base Capacity (vph) | 489 | 1896 | 442 | 1070 | 833 | 243 | 375 | 448 | 750 |
| Starvation Cap Reductn | 0 | 0 | 0 | 628 | 0 | 0 | 0 | 0 | 0 |
| Spillback Cap Reductn | 0 | 443 | 0 | 0 | 0 | 0 | 56 | 22 | 0 |
| Storage Cap Reductn | 0 | 0 | 0 | 0 | 0 | 0 | 0 | 0 | 0 |
| Reduced v/c Ratio | 0.08 | 0.40 | 0.12 | 0.77 | 0.10 | 0.28 | 0.36 | 0.34 | 0.20 |

Intersection Summary

Cycle Length: 110
 Actuated Cycle Length: 110
 Offset: 16 (15%), Referenced to phase 4:WBTL and 8:EBTL, Start of Green
 Natural Cycle: 70
 Control Type: Actuated-Coordinated
 Maximum v/c Ratio: 0.52
 Intersection Signal Delay: 25.1
 Intersection Capacity Utilization 68.6%
 Analysis Period (min) 15
 m Volume for 95th percentile queue is metered by upstream signal.

Intersection LOS: C
 ICU Level of Service C

Splits and Phases: 2: Young & Kempt

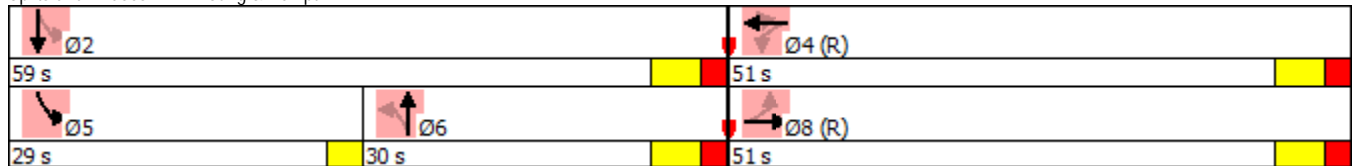

| Lane Group | EBL | EBT | EBR | WBL | WBT | NBL | NBT | SBL | SBT | SBR |
|------------------------|-------|-------|-------|-------|--------|-------|-------|-------|--------|-------|
| Lane Configurations | | | | | | | | | | |
| Traffic Volume (vph) | 100 | 405 | 115 | 20 | 260 | 80 | 495 | 60 | 731 | 80 |
| Future Volume (vph) | 100 | 405 | 115 | 20 | 260 | 80 | 495 | 60 | 731 | 80 |
| Lane Group Flow (vph) | 114 | 462 | 131 | 23 | 320 | 91 | 588 | 68 | 808 | 91 |
| Turn Type | pm+pt | NA | Perm | Perm | NA | pm+pt | NA | Perm | NA | Perm |
| Protected Phases | 3 | 8 | | | 4 | 1 | 6 | | 2 | |
| Permitted Phases | 8 | | 8 | 4 | | 6 | | 2 | | 2 |
| Detector Phase | 3 | 8 | 8 | 4 | 4 | 1 | 6 | 2 | 2 | 2 |
| Switch Phase | | | | | | | | | | |
| Minimum Initial (s) | 8.0 | 10.0 | 10.0 | 10.0 | 10.0 | 8.0 | 10.0 | 10.0 | 10.0 | 10.0 |
| Minimum Split (s) | 13.0 | 27.4 | 27.4 | 27.4 | 27.4 | 13.0 | 29.4 | 29.4 | 29.4 | 29.4 |
| Total Split (s) | 17.6 | 45.0 | 45.0 | 27.4 | 27.4 | 13.0 | 65.0 | 52.0 | 52.0 | 52.0 |
| Total Split (%) | 16.0% | 40.9% | 40.9% | 24.9% | 24.9% | 11.8% | 59.1% | 47.3% | 47.3% | 47.3% |
| Yellow Time (s) | 3.0 | 4.1 | 4.1 | 4.1 | 4.1 | 4.0 | 4.1 | 4.1 | 4.1 | 4.1 |
| All-Red Time (s) | 0.0 | 2.3 | 2.3 | 2.3 | 2.3 | 1.0 | 2.3 | 2.3 | 2.3 | 2.3 |
| Lost Time Adjust (s) | 0.0 | 0.0 | 0.0 | 0.0 | 0.0 | 0.0 | 0.0 | 0.0 | 0.0 | 0.0 |
| Total Lost Time (s) | 3.0 | 6.4 | 6.4 | 6.4 | 6.4 | 5.0 | 6.4 | 6.4 | 6.4 | 6.4 |
| Lead/Lag | Lead | | | Lag | Lag | | | | | |
| Lead-Lag Optimize? | | | | | | | | | | |
| Recall Mode | C-Max | C-Min | C-Min | Min | Min | None | Min | Min | Min | Min |
| Act Effct Green (s) | 42.0 | 38.6 | 38.6 | 21.0 | 21.0 | 60.0 | 58.6 | 48.2 | 48.2 | 48.2 |
| Actuated g/C Ratio | 0.38 | 0.35 | 0.35 | 0.19 | 0.19 | 0.55 | 0.53 | 0.44 | 0.44 | 0.44 |
| v/c Ratio | 0.39 | 0.75 | 0.23 | 0.16 | 0.96 | 0.49 | 0.33 | 0.22 | 1.08 | 0.13 |
| Control Delay | 29.8 | 47.0 | 9.0 | 40.4 | 84.3 | 23.6 | 15.0 | 23.1 | 87.3 | 2.7 |
| Queue Delay | 0.4 | 13.6 | 0.7 | 0.0 | 0.0 | 0.0 | 0.0 | 0.0 | 0.0 | 0.0 |
| Total Delay | 30.2 | 60.7 | 9.6 | 40.4 | 84.3 | 23.6 | 15.0 | 23.1 | 87.3 | 2.7 |
| LOS | C | E | A | D | F | C | B | C | F | A |
| Approach Delay | | 46.3 | | | 81.4 | | 16.2 | | 74.8 | |
| Approach LOS | | D | | | F | | B | | E | |
| Queue Length 50th (m) | 24.2 | 104.4 | 12.6 | 4.2 | 68.0 | 9.0 | 35.5 | 9.3 | -202.8 | 0.0 |
| Queue Length 95th (m) | 29.0 | 138.0 | 5.6 | 11.6 | #121.9 | 20.4 | 47.0 | 19.8 | #274.5 | 6.4 |
| Internal Link Dist (m) | | 50.7 | | | 218.5 | | 360.9 | | 359.6 | |
| Turn Bay Length (m) | 25.0 | | | | | 140.0 | | 70.0 | | 60.0 |
| Base Capacity (vph) | 291 | 615 | 562 | 145 | 334 | 185 | 1783 | 315 | 750 | 705 |
| Starvation Cap Reductn | 27 | 138 | 217 | 0 | 0 | 0 | 0 | 0 | 0 | 0 |
| Spillback Cap Reductn | 0 | 0 | 0 | 0 | 0 | 0 | 0 | 0 | 0 | 0 |
| Storage Cap Reductn | 0 | 0 | 0 | 0 | 0 | 0 | 0 | 0 | 0 | 0 |
| Reduced v/c Ratio | 0.43 | 0.97 | 0.38 | 0.16 | 0.96 | 0.49 | 0.33 | 0.22 | 1.08 | 0.13 |

Intersection Summary

Cycle Length: 110
 Actuated Cycle Length: 110
 Offset: 108 (98%), Referenced to phase 3:EBL and 8:EBTL, Start of Green
 Natural Cycle: 115
 Control Type: Actuated-Coordinated
 Maximum v/c Ratio: 1.08
 Intersection Signal Delay: 53.4
 Intersection Capacity Utilization 97.9%
 Analysis Period (min) 15
 ~ Volume exceeds capacity, queue is theoretically infinite.
 Queue shown is maximum after two cycles.
 # 95th percentile volume exceeds capacity, queue may be longer.
 Queue shown is maximum after two cycles.

Splits and Phases: 3: Robie & Young

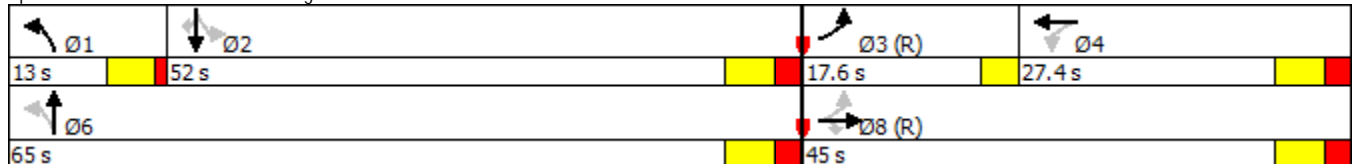

| Lane Group | EBL | EBT | WBL | WBT | WBR | NBL2 | NBT | SBL | SBT |
|------------------------|-------|-------|-------|-------|-------|-------|-------|-------|-------|
| Lane Configurations | | | | | | | | | |
| Traffic Volume (vph) | 160 | 450 | 20 | 432 | 13 | 105 | 65 | 210 | 60 |
| Future Volume (vph) | 160 | 450 | 20 | 432 | 13 | 105 | 65 | 210 | 60 |
| Lane Group Flow (vph) | 183 | 742 | 23 | 493 | 146 | 120 | 103 | 240 | 171 |
| Turn Type | Perm | NA | Perm | NA | Perm | Perm | NA | pm+pt | NA |
| Protected Phases | | 8 | | 4 | | | 6 | 5 | 2 |
| Permitted Phases | 8 | | 4 | | 4 | 6 | | 2 | |
| Detector Phase | 8 | 8 | 4 | 4 | 4 | 6 | 6 | 5 | 2 |
| Switch Phase | | | | | | | | | |
| Minimum Initial (s) | 10.0 | 10.0 | 10.0 | 10.0 | 10.0 | 10.0 | 10.0 | 8.0 | 10.0 |
| Minimum Split (s) | 27.4 | 27.4 | 27.4 | 27.4 | 27.4 | 29.4 | 29.4 | 13.0 | 29.4 |
| Total Split (s) | 47.0 | 47.0 | 47.0 | 47.0 | 47.0 | 30.0 | 30.0 | 13.0 | 43.0 |
| Total Split (%) | 52.2% | 52.2% | 52.2% | 52.2% | 52.2% | 33.3% | 33.3% | 14.4% | 47.8% |
| Yellow Time (s) | 4.1 | 4.1 | 4.1 | 4.1 | 4.1 | 4.1 | 4.1 | 3.0 | 4.1 |
| All-Red Time (s) | 2.3 | 2.3 | 2.3 | 2.3 | 2.3 | 2.3 | 2.3 | 0.0 | 2.3 |
| Lost Time Adjust (s) | 0.0 | 0.0 | 0.0 | 0.0 | 0.0 | 0.0 | 0.0 | 0.0 | 0.0 |
| Total Lost Time (s) | 6.4 | 6.4 | 6.4 | 6.4 | 6.4 | 6.4 | 6.4 | 3.0 | 6.4 |
| Lead/Lag | | | | | | Lag | Lag | Lead | |
| Lead-Lag Optimize? | | | | | | | | | |
| Recall Mode | C-Min | C-Min | C-Min | C-Min | C-Min | Min | Min | None | Min |
| Act Effect Green (s) | 46.9 | 46.9 | 46.9 | 46.9 | 46.9 | 15.2 | 15.2 | 33.7 | 30.3 |
| Actuated g/C Ratio | 0.52 | 0.52 | 0.52 | 0.52 | 0.52 | 0.17 | 0.17 | 0.37 | 0.34 |
| v/c Ratio | 0.59 | 0.46 | 0.08 | 0.53 | 0.20 | 0.63 | 0.33 | 0.52 | 0.33 |
| Control Delay | 26.3 | 13.2 | 7.1 | 9.5 | 0.9 | 48.6 | 27.5 | 24.3 | 23.4 |
| Queue Delay | 0.0 | 0.0 | 0.0 | 2.5 | 0.5 | 0.0 | 0.1 | 0.3 | 0.0 |
| Total Delay | 26.3 | 13.2 | 7.1 | 12.0 | 1.5 | 48.6 | 27.6 | 24.6 | 23.4 |
| LOS | C | B | A | B | A | D | C | C | C |
| Approach Delay | | 15.8 | | 9.5 | | | 38.9 | | 24.1 |
| Approach LOS | | B | | A | | | D | | C |
| Queue Length 50th (m) | 22.0 | 36.2 | 1.1 | 23.9 | 0.0 | 19.6 | 12.6 | 28.5 | 20.9 |
| Queue Length 95th (m) | #54.9 | 53.4 | m1.3 | m25.6 | m0.0 | 34.1 | 24.4 | 44.7 | 35.0 |
| Internal Link Dist (m) | | 97.3 | | 50.7 | | | 38.9 | | 145.1 |
| Turn Bay Length (m) | 45.0 | | 12.0 | | | | | 30.0 | |
| Base Capacity (vph) | 309 | 1619 | 301 | 939 | 717 | 297 | 469 | 466 | 630 |
| Starvation Cap Reductn | 0 | 0 | 0 | 316 | 307 | 0 | 0 | 0 | 0 |
| Spillback Cap Reductn | 0 | 3 | 0 | 0 | 0 | 0 | 56 | 32 | 0 |
| Storage Cap Reductn | 0 | 0 | 0 | 0 | 0 | 0 | 0 | 0 | 0 |
| Reduced v/c Ratio | 0.59 | 0.46 | 0.08 | 0.79 | 0.36 | 0.40 | 0.25 | 0.55 | 0.27 |

Intersection Summary

Cycle Length: 90
 Actuated Cycle Length: 90
 Offset: 4 (4%), Referenced to phase 4:WBTL and 8:EBTL, Start of Green
 Natural Cycle: 80
 Control Type: Actuated-Coordinated
 Maximum v/c Ratio: 0.63
 Intersection Signal Delay: 17.8
 Intersection Capacity Utilization 78.7%
 Analysis Period (min) 15
 # 95th percentile volume exceeds capacity, queue may be longer.
 Queue shown is maximum after two cycles.
 m Volume for 95th percentile queue is metered by upstream signal.

Splits and Phases: 2: Young Street & Kempt

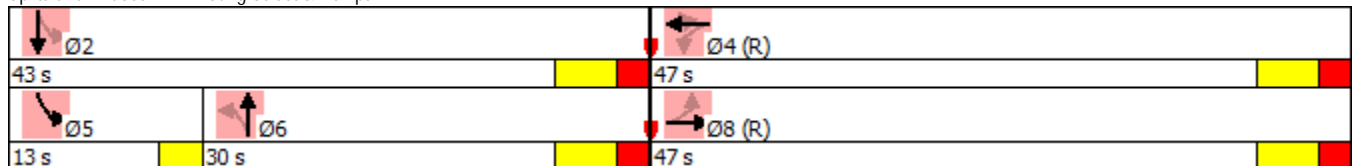

| Lane Group | EBL | EBT | EBR | WBL | WBT | NBL | NBT | SBL | SBT | SBR |
|------------------------|-------|-------|--------|-------|--------|-------|-------|-------|--------|-------|
| Lane Configurations | | | | | | | | | | |
| Traffic Volume (vph) | 160 | 325 | 200 | 15 | 340 | 165 | 850 | 35 | 416 | 75 |
| Future Volume (vph) | 160 | 325 | 200 | 15 | 340 | 165 | 850 | 35 | 416 | 75 |
| Lane Group Flow (vph) | 183 | 371 | 228 | 17 | 456 | 188 | 956 | 40 | 475 | 86 |
| Turn Type | pm+pt | NA | custom | Perm | NA | pm+pt | NA | Perm | NA | Perm |
| Protected Phases | 3 | 8 | | | 4 | 1 | 6 | | 2 | |
| Permitted Phases | 8 | | 1 8 | 4 | | 6 | | 2 | | 2 |
| Detector Phase | 3 | 8 | 1 8 | 4 | 4 | 1 | 6 | 2 | 2 | 2 |
| Switch Phase | | | | | | | | | | |
| Minimum Initial (s) | 8.0 | 10.0 | | 10.0 | 10.0 | 7.0 | 10.0 | 10.0 | 10.0 | 10.0 |
| Minimum Split (s) | 13.0 | 27.4 | | 27.4 | 27.4 | 11.0 | 29.4 | 29.4 | 29.4 | 29.4 |
| Total Split (s) | 13.0 | 44.0 | | 31.0 | 31.0 | 13.0 | 46.0 | 33.0 | 33.0 | 33.0 |
| Total Split (%) | 14.4% | 48.9% | | 34.4% | 34.4% | 14.4% | 51.1% | 36.7% | 36.7% | 36.7% |
| Yellow Time (s) | 3.0 | 4.1 | | 4.1 | 4.1 | 3.0 | 4.1 | 4.1 | 4.1 | 4.1 |
| All-Red Time (s) | 0.0 | 2.3 | | 2.3 | 2.3 | 0.0 | 2.3 | 2.3 | 2.3 | 2.3 |
| Lost Time Adjust (s) | 0.0 | 0.0 | | 0.0 | 0.0 | 0.0 | 0.0 | 0.0 | 0.0 | 0.0 |
| Total Lost Time (s) | 3.0 | 6.4 | | 6.4 | 6.4 | 3.0 | 6.4 | 6.4 | 6.4 | 6.4 |
| Lead/Lag | Lead | | | Lag | Lag | | | | | |
| Lead-Lag Optimize? | | | | | | | | | | |
| Recall Mode | None | C-Min | | C-Min | C-Min | None | Min | Min | Min | Min |
| Act Effct Green (s) | 42.0 | 38.6 | 54.5 | 26.0 | 26.0 | 42.0 | 38.6 | 26.1 | 26.1 | 26.1 |
| Actuated g/C Ratio | 0.47 | 0.43 | 0.61 | 0.29 | 0.29 | 0.47 | 0.43 | 0.29 | 0.29 | 0.29 |
| v/c Ratio | 0.64 | 0.48 | 0.25 | 0.06 | 0.90 | 0.66 | 0.65 | 0.28 | 0.94 | 0.17 |
| Control Delay | 29.3 | 17.8 | 4.6 | 25.2 | 54.5 | 25.9 | 22.7 | 30.7 | 60.2 | 3.4 |
| Queue Delay | 0.2 | 2.2 | 0.5 | 0.0 | 1.7 | 0.0 | 0.0 | 0.0 | 0.0 | 0.0 |
| Total Delay | 29.5 | 19.9 | 5.1 | 25.2 | 56.2 | 25.9 | 22.7 | 30.7 | 60.2 | 3.4 |
| LOS | C | B | A | C | E | C | C | C | E | A |
| Approach Delay | | 17.9 | | | 55.1 | | 23.2 | | 50.1 | |
| Approach LOS | | B | | | E | | C | | D | |
| Queue Length 50th (m) | 15.7 | 35.4 | 3.7 | 2.2 | 75.9 | 18.3 | 65.3 | 5.3 | 79.1 | 0.0 |
| Queue Length 95th (m) | #40.2 | 55.2 | 16.1 | 7.2 | #134.3 | #32.2 | 85.3 | 14.3 | #135.9 | 6.3 |
| Internal Link Dist (m) | | 50.7 | | | 218.5 | | 360.9 | | 255.1 | |
| Turn Bay Length (m) | 25.0 | | | 15.0 | | 140.0 | | 70.0 | | 60.0 |
| Base Capacity (vph) | 289 | 766 | 931 | 267 | 506 | 294 | 1505 | 145 | 517 | 515 |
| Starvation Cap Reductn | 4 | 258 | 379 | 0 | 0 | 0 | 0 | 0 | 0 | 0 |
| Spillback Cap Reductn | 0 | 0 | 0 | 0 | 11 | 0 | 0 | 0 | 0 | 0 |
| Storage Cap Reductn | 0 | 0 | 0 | 0 | 0 | 0 | 0 | 0 | 0 | 0 |
| Reduced v/c Ratio | 0.64 | 0.73 | 0.41 | 0.06 | 0.92 | 0.64 | 0.64 | 0.28 | 0.92 | 0.17 |

Intersection Summary

Cycle Length: 90
 Actuated Cycle Length: 90
 Offset: 0 (0%), Referenced to phase 4:WBTL and 8:EBTL, Start of Green, Master Intersection
 Natural Cycle: 85
 Control Type: Actuated-Coordinated
 Maximum v/c Ratio: 0.94
 Intersection Signal Delay: 32.2
 Intersection Capacity Utilization 85.7%
 Analysis Period (min) 15
 # 95th percentile volume exceeds capacity, queue may be longer.
 Queue shown is maximum after two cycles.

Splits and Phases: 3: Robie & Young Street

| | | | |
|------|------|------|------|
| | | | |
| 13 s | 33 s | 13 s | 31 s |
| | | | |
| 46 s | | 44 s | |

Attachment A

APPENDIX

G

ROBIE STREET
INTERSECTION
CAPACITY
ANALYSIS

Attachment A

Attachment A

Table G-1 - Robie Street AM Peak Hour Intersection Analysis

| Intersection | | AM Peak Hour | | | | | | | | | | | |
|------------------------|-------------------------|------------------------|-----------------------|-------|-------|-------|--|--|-----------------------|-------|------|-------|-------|
| | | Existing Conditions | | | | | Preferred Option | | | | | | |
| | | Scenario | Approach ¹ | Delay | V/C | LOS | Queue | Option | Approach ¹ | Delay | V/C | LOS | Queue |
| Robie Street @ | Almon | Existing (Page G-3) | EB-L | 45.2 | 0.68 | D | 57.8 | Curbside Lanes both directions ² (Page G-21) | EB-L | 70.3 | 0.82 | E | 67.7 |
| | | | EB-TR | 45.3 | 0.80 | D | 112.8 | | EB-TR | 56.7 | 0.84 | E | 115.3 |
| | | | WB-LT | 37.3 | 0.63 | D | 66.0 | | WB-LT | 66.9 | 0.85 | E | 87.6 |
| | | | WB-R | 5.2 | 0.13 | A | 6.1 | | WB-R | 9.0 | 0.14 | A | 9.0 |
| | | | NB-LTR | 14.0 | 0.46 | B | 45.0 | | NB-L | 11.2 | 0.10 | B | 8.3 |
| | | | NB-T | 15.6 | 0.14 | B | 11.5 | | NB-T | 15.6 | 0.53 | B | 103.1 |
| | SB-L | 15.6 | 0.14 | B | 11.5 | SB-L | 5.1 | 0.03 | A | 4.4 | | | |
| | SB-T | 35.7 | 0.86 | D | 173.2 | SB-T | 7.6 | 0.10 | A | 1.1 | | | |
| | SB-R | 2.6 | 0.31 | A | 10.5 | SB-T | 12.2 | 0.58 | B | 14.2 | | | |
| | SB-R | 2.6 | 0.31 | A | 10.5 | SB-R | 5.2 | 0.25 | A | 18.4 | | | |
| | North | Existing (Page G-4) | EB-TR | 47.8 | 0.89 | D | 118.0 | Curbside Lanes both directions ² (Page G-22) | EB-TR | 42.8 | 0.85 | D | 99.8 |
| | | | WB-TR | 42.8 | 0.86 | D | 115.7 | | WB-TR | 39.4 | 0.82 | D | 103.7 |
| | | | NB-T | 20.9 | 0.71 | C | 132.0 | | NB-T | 32.9 | 0.60 | C | 116.9 |
| | | | NB-R | 2.9 | 0.18 | A | 8.4 | | NB-Transit | 10.3 | 0.01 | B | 3.6 |
| | SB-TR | 26.5 | 0.77 | C | 159.8 | NB-R | 14.9 | 0.16 | B | 18.4 | | | |
| | SB-T | 19.4 | 0.64 | B | 123.5 | SB-T | 19.4 | 0.64 | B | 123.5 | | | |
| | SB-R | 8.5 | 0.03 | A | 5.2 | SB-R | 8.5 | 0.03 | A | 5.2 | | | |
| | Cunard | Existing (Page G-5) | EB-L | 19.0 | 0.04 | B | 4.7 | Curbside Lanes both directions ² (Page G-23) | EB-L | 13.4 | 0.03 | B | 3.8 |
| | | | EB-TR | 145.0 | 1.22 | F | 183.6 | | EB-TR | 44.5 | 0.92 | D | 146.8 |
| | | | WB-L | 38.2 | 0.45 | D | 18.3 | | WB-L | 18.4 | 0.23 | B | 12.2 |
| | | | WB-T | 23.2 | 0.35 | C | 39.6 | | WB-T | 16.5 | 0.26 | B | 31.8 |
| | | | WB-R | 0.4 | 0.09 | A | 0.0 | | WB-R | 4.0 | 0.08 | A | 4.9 |
| | | | NB-L | 56.1 | 0.55 | E | 23.8 | | NB-L | 83.8 | 0.76 | F | 31.5 |
| | | | NB-TR | 24.8 | 0.51 | C | 56.2 | | NB-T | 34.5 | 0.74 | C | 129.7 |
| | SB-LTR | 53.0 | 1.02 | D | 122.1 | NB-R | 9.9 | 0.05 | A | 6.8 | | | |
| | SB-L | 34.0 | 0.45 | C | 22.7 | SB-L | 34.0 | 0.45 | C | 22.7 | | | |
| | SB-T | 67.9 | 1.03 | E | 207.2 | SB-T | 67.9 | 1.03 | E | 207.2 | | | |
| | SB-R | 9.1 | 0.04 | A | 4.2 | SB-R | 9.1 | 0.04 | A | 4.2 | | | |
| | Quinpool | Existing (Page G-6) | EB-T | 150.7 | 1.18 | F | 233.5 | Curbside Lanes both directions ² (Page G-24) | EB-T | 110.2 | 1.05 | F | 219.0 |
| | | | EB-R | 41.9 | 0.79 | D | 183.0 | | EB-R | 35.9 | 0.71 | D | 167.1 |
| | | | EB-R2 | 70.7 | 1.01 | E | 144.7 | | EB-R2 | 55.8 | 0.95 | E | 135.6 |
| | | | WB-TR | 46.7 | 0.37 | D | 47.3 | | WB-TR | 45.9 | 0.33 | D | 46.6 |
| | | | NB-L | 81.9 | 0.79 | F | 73.6 | | NB-L | 47.7 | 0.73 | D | 52.5 |
| | | | NB-TR | 50.2 | 0.61 | D | 88.0 | | NB-T | 49.8 | 0.51 | D | 77.3 |
| | | | SB-L | 193.6 | 1.28 | F | 163.0 | | NB-R | 43.8 | 0.21 | D | 25.6 |
| | SB-TR | 120.9 | 1.13 | F | 201.6 | SB-L | 63.9 | 0.93 | E | 117.7 | | | |
| | SB-T | 53.3 | 0.80 | D | 141.5 | SB-T | 53.3 | 0.80 | D | 141.5 | | | |
| | SB-R | 14.0 | 0.16 | B | 16.2 | SB-R | 14.0 | 0.16 | B | 16.2 | | | |
| | NW-LR | 74.3 | 0.84 | E | 85.9 | NW-LR | 66.5 | 0.75 | E | 78.2 | | | |
| | Jubilee | Existing (Page G-7) | EB-LTR | 49.5 | 0.90 | D | 132.8 | Curbside Lanes both directions ² (Page G-25) | EB-LTR | 50.5 | 0.86 | D | 140.4 |
| | | | WB-LT | 22.1 | 0.26 | C | 31.1 | | WB-LT | 27.9 | 0.25 | C | 37.5 |
| | | | WB-R | 4.8 | 0.21 | A | 9.8 | | WB-R | 5.4 | 0.20 | A | 11.2 |
| | | | NB-L | 35.8 | 0.38 | D | 18.6 | | NB-L | 35.7 | 0.29 | D | 21.8 |
| | | | NB-TR | 30.3 | 0.64 | C | 85.7 | | NB-T | 32.8 | 0.42 | C | 80.2 |
| | | | SB-L | 25.7 | 0.66 | C | 44.6 | | NB-R | 4.7 | 0.12 | A | 2.0 |
| | | | SB-T | 22.9 | 0.69 | C | 109.8 | | SB-L | 19.6 | 0.53 | B | 43.1 |
| | SB-R | 2.7 | 0.05 | A | 2.6 | SB-T | 20.1 | 0.56 | C | 105.8 | | | |
| | SB-R | 2.7 | 0.05 | A | 2.6 | SB-R | 6.9 | 0.06 | A | 7.3 | | | |
| Spring Garden / Coburg | Existing (Page G-8) | EB-L | 32.3 | 0.25 | C | 18.0 | Curbside Lanes both directions ² (Page G-26) | EB-L | 54.2 | 0.44 | D | 22.5 | |
| | | EB-TR | 33.2 | 0.42 | C | 51.0 | | EB-T | 52.3 | 0.60 | D | 62.0 | |
| | | WB-LTR | 23.1 | 0.52 | C | 33.8 | | WB-LTR | 50.3 | 0.82 | D | 46.5 | |
| | | NB-LT | 20.5 | 0.58 | C | 42.5 | | NB-L | 15.3 | 0.18 | B | 21.3 | |
| | | NB-R | 0.70 | 0.31 | A | 0.2 | | NB-T | 11.9 | 0.25 | B | 58.3 | |
| | | SB-LT | 20.8 | 0.92 | C | 22.5 | | NB-R | 1.6 | 0.05 | A | 1.7 | |
| SB-R | 0.20 | 0.08 | A | 0.00 | SB-L | 10.9 | 0.41 | B | 65.7 | | | | |
| SB-T | 23.8 | 0.69 | C | 242.7 | SB-T | 23.8 | 0.69 | C | 242.7 | | | | |
| SB-R | 2.1 | 0.07 | A | 2.9 | SB-R | 2.1 | 0.07 | A | 2.9 | | | | |
| University | Existing (Page G-9) | EB-L | 31.2 | 0.17 | C | 13.3 | Curbside Lanes both directions ² (Page G-27) | EB-L | 40.9 | 0.18 | D | 15.7 | |
| | | EB-TR | 36.2 | 0.53 | D | 52.6 | | EB-TR | 47.3 | 0.56 | D | 62.8 | |
| | | WB-L | 31.5 | 0.17 | C | 13.4 | | WB-L | 42.0 | 0.20 | D | 15.9 | |
| | | WB-T | 31.6 | 0.26 | C | 28.6 | | WB-T | 41.3 | 0.27 | D | 34.1 | |
| | | WB-R | 9.9 | 0.37 | A | 13.6 | | WB-R | 11.5 | 0.39 | B | 15.4 | |
| | | NB-LT | 20.3 | 0.36 | C | 25.5 | | NB-L | 13.7 | 0.03 | B | 2.8 | |
| | | NB-R | 18.0 | 0.13 | B | 9.2 | | NB-T | 17.6 | 0.25 | B | 36.3 | |
| | | SB-L | 10.7 | 0.69 | B | 18.4 | | NB-R | 2.2 | 0.08 | A | 2.1 | |
| SB-T | 8.2 | 0.64 | A | 30.4 | SB-L | 11.1 | 0.55 | B | 73.8 | | | | |
| SB-R | 3.0 | 0.09 | A | 1.0 | SB-T | 10.3 | 0.51 | B | 102.4 | | | | |
| SB-R | 3.0 | 0.09 | A | 1.0 | SB-R | 5.0 | 0.07 | A | 6.6 | | | | |
| South | Existing (Page G-10) | EB-LTR | 34.3 | 0.76 | C | 101.5 | Curbside Lanes both directions ² (Page G-28) | EB-LTR | 41.8 | 0.77 | D | 106.4 | |
| | | WB-LTR | 19.1 | 0.45 | B | 50.9 | | WB-LTR | 24.9 | 0.45 | C | 55.9 | |
| | | NB-LT | 16.4 | 0.26 | B | 22.4 | | NB-L | 32.1 | 0.10 | C | 14.2 | |
| | | NB-R | 3.6 | 0.08 | A | 3.0 | | NB-T | 34.2 | 0.41 | C | 83.8 | |
| | | SB-LT | 25.0 | 0.63 | C | 48.6 | | NB-R | 13.8 | 0.10 | B | 10.2 | |
| SB-R | 4.7 | 0.11 | A | 1.3 | SB-L | 23.1 | 0.43 | C | 49.1 | | | | |
| SB-T | 25.5 | 0.40 | C | 80.0 | SB-T | 25.5 | 0.40 | C | 80.0 | | | | |
| SB-R | 0.2 | 0.07 | A | 0.0 | SB-R | 0.2 | 0.07 | A | 0.0 | | | | |
| Inglis | Existing (Page G-11) | EB-LTR | 40.9 | 0.77 | D | 83.4 | Curbside Lanes both directions ² (Page G-29) | EB-LTR | 33.8 | 0.70 | C | 75.2 | |
| | | WB-LR | 59.8 | 0.88 | E | 75.6 | | WB-LR | 44.2 | 0.79 | D | 67.0 | |
| | | WB-R | 5.3 | 0.38 | A | 12.8 | | WB-R | 4.9 | 0.35 | A | 12.6 | |
| | | NB-L | 12.9 | 0.02 | B | 4.2 | | NB-L | 11.3 | 0.02 | B | 3.7 | |
| | | NB-TR | 7.5 | 0.14 | A | 13.9 | | NB-TR | 6.6 | 0.16 | A | 12.4 | |
| | | SB-L | 10.7 | 0.48 | B | 12.3 | | SB-L | 16.2 | 0.43 | B | 49.1 | |
| | | SB-T | 4.6 | 0.15 | A | 6.3 | | SB-T | 11.5 | 0.14 | B | 21.4 | |
| SB-R | 0.1 | 0.04 | A | 0.0 | SB-R | 1.7 | 0.03 | A | 1.9 | | | | |

Notes:

1. Robie Street is north/south for the full corridor
2. See Appendix A for modification option.

Attachment A

Table G-2 - Robie Street PM Peak Hour Intersection Analysis

| Intersection | | PM Peak Hour | | | | | | | | | | | | | |
|----------------|-------------------------|-------------------------|-------------------------|-------|--------|--------|--|--|-----------------------|--|-------|-------|-------|---|-------|
| | | Existing Conditions | | | | | Preferred Option | | | | | | | | |
| | | Scenario | Approach ¹ | Delay | V/C | LOS | Queue | Option | Approach ¹ | Delay | V/C | LOS | Queue | | |
| Robie Street @ | Almon | Existing (Page G-12) | EB-L | 43.3 | 0.80 | D | 68.5 | Curbside Lanes both directions ² (Page G-30) | EB-L | 76.9 | 0.95 | E | 87.7 | | |
| | | | EB-TR | 18.4 | 0.36 | B | 55.7 | | EB-TR | 27.8 | 0.42 | C | 72.1 | | |
| | | | WB-LT | 63.0 | 0.96 | E | 169.3 | | WB-LT | 75.5 | 0.97 | E | 198.1 | | |
| | | | WB-R | 9.4 | 0.27 | A | 18.1 | | WB-R | 18.7 | 0.33 | B | 29.1 | | |
| | | | NB-LTR | 34.2 | 0.84 | C | 101.3 | | NB-L | 15.6 | 0.09 | B | 9.6 | | |
| | | | NB-T | | | | | | NB-T | 50.8 | 0.96 | D | 269.1 | | |
| | | | NB-R | | | | | | NB-R | 9.9 | 0.03 | A | 6.1 | | |
| | | SB-L | 26.4 | 0.17 | C | 9.2 | SB-L | | 17.4 | 0.33 | B | 1.9 | | | |
| | | SB-T | 37.1 | 0.72 | D | 99.3 | SB-T | | 7.0 | 0.46 | A | 26.0 | | | |
| | | SB-R | 4.5 | 0.27 | A | 12.0 | SB-R | | 5.9 | 0.36 | A | 18.8 | | | |
| | | SB-T | | | | | SB-T | | | | | | | | |
| | | SB-R | | | | | SB-R | | | | | | | | |
| | | North | Existing (Page G-13) | EB-TR | 36.5 | 0.75 | D | | 95.4 | Curbside Lanes both directions ² (Page G-31) | EB-TR | 36.5 | 0.75 | D | 95.4 |
| | | | | WB-TR | 50.1 | 0.91 | D | | 139.1 | | WB-TR | 50.1 | 0.91 | D | 139.1 |
| | NB-T | | | 13.9 | 0.79 | B | 179.2 | NB-T | 23.0 | | 0.77 | C | 150.8 | | |
| | NB-R | | | 48.3 | 0.98 | D | 124.9 | NB-Transit | 9.8 | | 0.02 | A | 3.9 | | |
| | SB-TR | | | 17.9 | 0.64 | B | 110.6 | NB-R | 54.9 | | 0.98 | D | 121.9 | | |
| | Cunard | Existing (Page G-14) | EB-L | 25.4 | 0.21 | C | 9.1 | Curbside Lanes both directions ² (Page G-32) | EB-L | 47.0 | 0.35 | D | 12.8 | | |
| | | | EB-TR | 35.8 | 0.77 | D | 103.6 | | EB-TR | 43.5 | 0.71 | D | 102.2 | | |
| | | | WB-L | 25.5 | 0.32 | C | 20.6 | | WB-L | 34.7 | 0.34 | C | 26.3 | | |
| | | | WB-T | 38.3 | 0.82 | D | 135.4 | | WB-T | 58.6 | 0.91 | E | 175.7 | | |
| | | | WB-R | 2.8 | 0.15 | A | 5.7 | | WB-R | 12.7 | 0.18 | B | 16.1 | | |
| | | | NB-L | 50.6 | 0.44 | D | 21.4 | | NB-L | 12.8 | 0.18 | B | 11.8 | | |
| | | | NB-TR | 29.4 | 0.74 | C | 98.9 | | NB-T | 31.1 | 0.83 | C | 239.8 | | |
| | | | SB-LTR | 39.7 | 0.92 | D | 108.6 | | NB-R | 4.6 | 0.10 | A | 8.9 | | |
| | Quinpool | Existing (Page G-15) | EB-T | 72.7 | 0.72 | E | 103.1 | Curbside Lanes both directions ² (Page G-33) | EB-T | 66.1 | 0.68 | E | 98.6 | | |
| | | | EB-R | 26.0 | 0.43 | C | 89.8 | | EB-R | 22.9 | 0.41 | C | 82.6 | | |
| | | | EB-R2 | 8.6 | 0.34 | A | 19.0 | | EB-R2 | 13.7 | 0.46 | B | 24.6 | | |
| | | | WB-TR | 130.1 | 1.13 | F | 173.1 | | WB-TR | 93.4 | 1.00 | F | 149.2 | | |
| | | | NB-L | 132.2 | 1.08 | F | 132.1 | | NB-L | 80.9 | 0.97 | F | 107.9 | | |
| | | | NB-TR | 103.9 | 1.07 | F | 212.7 | | NB-T | 89.6 | 1.02 | F | 183.5 | | |
| | | | SB-L | 132.2 | 1.05 | F | 122.7 | | NB-R | 47.9 | 0.28 | D | 37.8 | | |
| | | | SB-TR | 61.9 | 0.83 | E | 132.4 | | SB-L | 120.3 | 1.08 | F | 118.5 | | |
| | Jubilee | Existing (Page G-16) | NW-LR | 99.5 | 1.06 | F | 204.1 | Curbside Lanes both directions ² (Page G-34) | SB-T | 60.5 | 0.79 | E | 114.0 | | |
| | | | EB-LTR | 62.8 | 0.91 | E | 82.0 | | SB-R | 16.0 | 0.24 | A | 19.6 | | |
| | | | WB-LT | 35.8 | 0.73 | D | 88.9 | | NW-LR | 87.8 | 1.02 | F | 193.6 | | |
| | | | WB-R | 6.0 | 0.27 | A | 12.4 | | EB-LTR | 30.1 | 0.53 | C | 74.9 | | |
| | | | NB-L | 5.2 | 0.51 | A | 9.9 | | WB-LT | 29.5 | 0.54 | C | 105.0 | | |
| | | | NB-TR | 14.8 | 0.66 | B | 74.3 | | WB-R | 9.7 | 0.23 | A | 20.1 | | |
| | | | SB-L | 14.6 | 0.41 | B | 18.4 | | NB-L | 32.8 | 0.64 | C | 42.3 | | |
| | | | SB-T | 23.6 | 0.54 | C | 71.7 | | NB-T | 24.7 | 0.68 | C | 51.7 | | |
| | Spring Garden / Coburg | Existing (Page G-17) | SB-R | 0.3 | 0.08 | A | 0.0 | Curbside Lanes both directions ² (Page G-35) | NB-R | 19.2 | 0.20 | A | 17.3 | | |
| | | | EB-L | 33.5 | 0.39 | C | 20.8 | | SB-L | 24.7 | 0.50 | C | 24.6 | | |
| | | | EB-T | 25.3 | 0.27 | C | 35.4 | | SB-T | 34.9 | 0.61 | C | 84.5 | | |
| | | | WB-LTR | 29.0 | 0.73 | C | 60.8 | | SB-R | 8.8 | 0.09 | A | 9.7 | | |
| | | | NB-LT | 78.6 | 1.11 | E | 142.2 | | EB-L | 45.3 | 0.47 | D | 24.8 | | |
| | | | NB-R | 0.3 | 0.08 | A | 0.0 | | EB-T | 32.8 | 0.29 | C | 41.1 | | |
| | | | SB-LT | 6.9 | 0.57 | A | 18.3 | | WB-LTR | 42.5 | 0.80 | D | 76.5 | | |
| SB-R | | | 0.1 | 0.05 | A | 0.00 | NB-L | | 14.2 | 0.38 | B | 33.6 | | | |
| University | Existing (Page G-18) | NB-T | | | | | Curbside Lanes both directions ² (Page G-36) | NB-T | 24.7 | 0.54 | C | 99.1 | | | |
| | | EB-L | 26.9 | 0.21 | C | 15.9 | | NB-R | 7.4 | 0.09 | A | 8.0 | | | |
| | | EB-TR | 24.9 | 0.30 | C | 31.6 | | SB-L | 38.9 | 0.40 | D | 41.6 | | | |
| | | WB-L | 24.5 | 0.09 | C | 10.1 | | SB-T | 57.2 | 0.56 | E | 100.2 | | | |
| | | WB-T | 27.9 | 0.35 | C | 39.3 | | SB-R | 3.7 | 0.07 | A | 4.5 | | | |
| | | WB-R | 10.9 | 0.60 | B | 24.4 | | EB-L | 38.5 | 0.27 | D | 19.7 | | | |
| | | NB-LT | 22.1 | 0.69 | C | 51.8 | | EB-TR | 35.4 | 0.36 | D | 39.8 | | | |
| | | NB-R | 13.5 | 0.08 | B | 5.5 | | WB-L | 34.0 | 0.12 | C | 12.5 | | | |
| South | Existing (Page G-19) | SB-L | 16.6 | 0.42 | B | 29.2 | Curbside Lanes both directions ² (Page G-37) | WB-T | 39.2 | 0.42 | D | 49.1 | | | |
| | | SB-T | 16.6 | 0.36 | B | 56.0 | | WB-R | 12.4 | 0.64 | B | 25.1 | | | |
| | | SB-R | 9.9 | 0.08 | A | 6.9 | | NB-L | 11.8 | 0.07 | B | 7.0 | | | |
| | | EB-LTR | 16.9 | 0.51 | B | 48.80 | | NB-T | 14.3 | 0.49 | B | 52.2 | | | |
| | | WB-LTR | 24.8 | 0.81 | C | 118.80 | | NB-R | 14.0 | 0.07 | B | 11.3 | | | |
| | | NB-LT | 25.6 | 0.45 | C | 41.50 | | SB-L | 9.2 | 0.35 | A | 19.4 | | | |
| Inglis | Existing (Page G-20) | NB-R | 1.8 | 0.04 | A | 0.20 | Curbside Lanes both directions ² (Page G-38) | SB-T | 10.3 | 0.31 | B | 43.3 | | | |
| | | SB-LT | 23.3 | 0.47 | C | 34.30 | | SB-R | 8.2 | 0.08 | A | 9.7 | | | |
| | | SB-R | 6.9 | 0.14 | A | 4.10 | | EB-LTR | 25.1 | 0.58 | C | 71.6 | | | |
| | | EB-LTR | 24.4 | 0.52 | C | 56.7 | | WB-LT | 38.0 | 0.88 | D | 178.1 | | | |
| | | WB-LR | 41.2 | 0.83 | D | 87.0 | | NB-L | 23.8 | 0.18 | C | 16.3 | | | |
| | | WB-R | 4.1 | 0.44 | A | 13.7 | | NB-T | 28.9 | 0.54 | C | 93.1 | | | |
| | | | | | NB-R | 8.4 | 0.04 | A | 4.9 | | | | | | |
| | | | | | SB-L | 26.9 | 0.42 | C | 35.8 | | | | | | |
| | | | | | SB-T | 23.9 | 0.48 | C | 78.4 | | | | | | |
| | | | | | SB-R | 1.4 | 0.10 | A | 0.0 | | | | | | |
| | | | | | EB-LTR | 10.3 | 0.31 | B | 44.2 | | | | | | |
| | | | | | WB-LR | 12.9 | 0.47 | B | 64.9 | | | | | | |
| | | | | | WB-R | 1.3 | 0.28 | A | 7.3 | | | | | | |
| | | | | | NB-LTR | 30.2 | 0.62 | C | 26.1 | | | | | | |
| | | | | | SB-L | 39.3 | 0.70 | D | 43.4 | | | | | | |
| | | | | | SB-T | 26.5 | 0.20 | C | 20.7 | | | | | | |
| | | | | | SB-R | 1.4 | 0.05 | A | 1.1 | | | | | | |

Notes:
 1. Robie Street is north/south for the full corridor
 2. See Appendix A for modification option.

| Lane Group | EBL | EBT | WBL2 | WBT | WBR | NBL | NBT | SBL | SBT | SBR |
|------------------------|-------|--------|-------|-------|-------|-------|-------|-------|--------|--------|
| Lane Configurations | | | | | | | | | | |
| Traffic Volume (vph) | 150 | 290 | 20 | 195 | 45 | 30 | 465 | 40 | 573 | 12 |
| Future Volume (vph) | 150 | 290 | 20 | 195 | 45 | 30 | 465 | 40 | 573 | 12 |
| Lane Group Flow (vph) | 171 | 388 | 0 | 246 | 51 | 0 | 582 | 46 | 654 | 248 |
| Turn Type | Perm | NA | Perm | NA | Perm | Perm | NA | Perm | NA | custom |
| Protected Phases | | 8 | | 4 | 4 | | 6 | | 2 | 1 |
| Permitted Phases | 8 | | 4 | | 4 | 6 | | 2 | | 2 |
| Detector Phase | 8 | 8 | 4 | 4 | 4 | 6 | 6 | 2 | 2 | 1 |
| Switch Phase | | | | | | | | | | |
| Minimum Initial (s) | 10.0 | 10.0 | 10.0 | 10.0 | 10.0 | 10.0 | 10.0 | 10.0 | 10.0 | 5.0 |
| Minimum Split (s) | 37.0 | 37.0 | 37.0 | 37.0 | 37.0 | 53.0 | 53.0 | 53.0 | 53.0 | 8.0 |
| Total Split (s) | 37.0 | 37.0 | 37.0 | 37.0 | 37.0 | 61.0 | 61.0 | 53.0 | 53.0 | 8.0 |
| Total Split (%) | 37.8% | 37.8% | 37.8% | 37.8% | 37.8% | 62.2% | 62.2% | 54.1% | 54.1% | 8.2% |
| Yellow Time (s) | 4.1 | 4.1 | 4.1 | 4.1 | 4.1 | 4.1 | 4.1 | 4.1 | 4.1 | 3.0 |
| All-Red Time (s) | 2.1 | 2.1 | 2.1 | 2.1 | 2.1 | 1.7 | 1.7 | 1.7 | 1.7 | 0.0 |
| Lost Time Adjust (s) | 0.0 | 0.0 | | 0.0 | 0.0 | | 0.0 | 0.0 | 0.0 | 0.0 |
| Total Lost Time (s) | 6.2 | 6.2 | | 6.2 | 6.2 | | 5.8 | 5.8 | 5.8 | 3.0 |
| Lead/Lag | | | | | | | | Lag | Lag | Lead |
| Lead-Lag Optimize? | | | | | | | | | | |
| Recall Mode | Max | Max | Max | Max | Max | C-Max | C-Max | C-Max | C-Max | Min |
| Act Effct Green (s) | 30.8 | 30.8 | | 30.8 | 30.8 | | 55.2 | 47.2 | 47.2 | 55.0 |
| Actuated g/C Ratio | 0.31 | 0.31 | | 0.31 | 0.31 | | 0.56 | 0.48 | 0.48 | 0.56 |
| v/c Ratio | 0.68 | 0.80 | | 0.63 | 0.13 | | 0.46 | 0.14 | 0.86 | 0.31 |
| Control Delay | 45.2 | 45.3 | | 37.3 | 5.2 | | 14.0 | 15.6 | 35.7 | 2.6 |
| Queue Delay | 0.0 | 0.0 | | 0.0 | 0.0 | | 0.0 | 0.0 | 0.0 | 0.0 |
| Total Delay | 45.2 | 45.3 | | 37.3 | 5.2 | | 14.0 | 15.6 | 35.7 | 2.6 |
| LOS | D | D | | D | A | | B | B | D | A |
| Approach Delay | | 45.3 | | 31.8 | | | 14.0 | | 26.0 | |
| Approach LOS | | D | | C | | | B | | C | |
| Queue Length 50th (m) | 28.1 | 67.1 | | 39.6 | 0.0 | | 31.8 | 4.7 | 105.3 | 1.0 |
| Queue Length 95th (m) | #57.8 | #112.8 | | 66.0 | 6.1 | | 45.0 | 11.5 | #173.2 | 10.5 |
| Internal Link Dist (m) | | 208.6 | | 311.8 | | | 93.8 | | 360.9 | |
| Turn Bay Length (m) | 80.0 | | | | 50.0 | | | 180.0 | | |
| Base Capacity (vph) | 251 | 483 | | 390 | 404 | | 1260 | 327 | 763 | 809 |
| Starvation Cap Reductn | 0 | 0 | | 0 | 0 | | 0 | 0 | 0 | 0 |
| Spillback Cap Reductn | 0 | 0 | | 0 | 0 | | 0 | 0 | 0 | 0 |
| Storage Cap Reductn | 0 | 0 | | 0 | 0 | | 0 | 0 | 0 | 0 |
| Reduced v/c Ratio | 0.68 | 0.80 | | 0.63 | 0.13 | | 0.46 | 0.14 | 0.86 | 0.31 |

Intersection Summary

Cycle Length: 98
 Actuated Cycle Length: 98
 Offset: 48 (49%), Referenced to phase 2:SBTL and 6:NBT, Start of Green
 Natural Cycle: 100
 Control Type: Actuated-Coordinated
 Maximum v/c Ratio: 0.86
 Intersection Signal Delay: 28.3
 Intersection Capacity Utilization 124.9%
 Analysis Period (min) 15
 # 95th percentile volume exceeds capacity, queue may be longer.
 Queue shown is maximum after two cycles.

Splits and Phases: 4: Robie & Almon

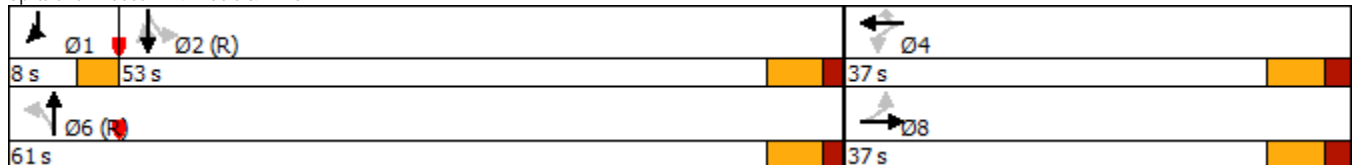

| | → | ← | ↑ | ↗ | ↓ |
|------------------------|--------|--------|--------|-------|--------|
| Lane Group | EBT | WBT | NBT | NBR | SBT |
| Lane Configurations | ↗ | ↗ | ↑ | ↗ | ↗ |
| Traffic Volume (vph) | 375 | 420 | 470 | 110 | 565 |
| Future Volume (vph) | 375 | 420 | 470 | 110 | 565 |
| Lane Group Flow (vph) | 457 | 490 | 536 | 126 | 656 |
| Turn Type | NA | NA | NA | Perm | NA |
| Protected Phases | 8 | 4 | 6 | | 2 |
| Permitted Phases | | | | 6 | |
| Detector Phase | 8 | 4 | 6 | 6 | 2 |
| Switch Phase | | | | | |
| Minimum Initial (s) | 10.0 | 10.0 | 10.0 | 10.0 | 10.0 |
| Minimum Split (s) | 23.7 | 23.7 | 49.0 | 49.0 | 49.0 |
| Total Split (s) | 41.0 | 41.0 | 49.0 | 49.0 | 49.0 |
| Total Split (%) | 45.6% | 45.6% | 54.4% | 54.4% | 54.4% |
| Yellow Time (s) | 4.1 | 4.1 | 4.1 | 4.1 | 4.1 |
| All-Red Time (s) | 1.6 | 1.6 | 1.5 | 1.5 | 1.5 |
| Lost Time Adjust (s) | 0.0 | 0.0 | 0.0 | 0.0 | 0.0 |
| Total Lost Time (s) | 5.7 | 5.7 | 5.6 | 5.6 | 5.6 |
| Lead/Lag | | | | | |
| Lead-Lag Optimize? | | | | | |
| Recall Mode | Ped | Ped | C-Max | C-Max | C-Max |
| Act Effct Green (s) | 31.7 | 31.7 | 47.0 | 47.0 | 47.0 |
| Actuated g/C Ratio | 0.35 | 0.35 | 0.52 | 0.52 | 0.52 |
| v/c Ratio | 0.89 | 0.86 | 0.71 | 0.18 | 0.77 |
| Control Delay | 47.8 | 42.8 | 20.9 | 2.9 | 26.5 |
| Queue Delay | 0.0 | 0.0 | 0.0 | 0.0 | 0.0 |
| Total Delay | 47.8 | 42.8 | 20.9 | 2.9 | 26.5 |
| LOS | D | D | C | A | C |
| Approach Delay | 47.8 | 42.8 | 17.5 | | 26.5 |
| Approach LOS | D | D | B | | C |
| Queue Length 50th (m) | 69.9 | 74.1 | 96.6 | 2.6 | 91.1 |
| Queue Length 95th (m) | #118.0 | #115.7 | #132.0 | 8.4 | #159.8 |
| Internal Link Dist (m) | 492.1 | 538.5 | 386.8 | | 285.2 |
| Turn Bay Length (m) | | | | | |
| Base Capacity (vph) | 571 | 633 | 756 | 686 | 847 |
| Starvation Cap Reductn | 0 | 0 | 0 | 0 | 0 |
| Spillback Cap Reductn | 0 | 0 | 0 | 0 | 0 |
| Storage Cap Reductn | 0 | 0 | 0 | 0 | 0 |
| Reduced v/c Ratio | 0.80 | 0.77 | 0.71 | 0.18 | 0.77 |

Intersection Summary

Cycle Length: 90
 Actuated Cycle Length: 90
 Offset: 8 (9%), Referenced to phase 2:SBT and 6:NBT, Start of Green
 Natural Cycle: 80
 Control Type: Actuated-Coordinated
 Maximum v/c Ratio: 0.89
 Intersection Signal Delay: 31.7
 Intersection Capacity Utilization 72.4%
 Analysis Period (min) 15
 # 95th percentile volume exceeds capacity, queue may be longer.
 Queue shown is maximum after two cycles.

Intersection LOS: C
 ICU Level of Service C

Splits and Phases: 5: Robie & North

| | |
|---------------------|-----------------|
| ↓ Ø2 (R) 49 s | ← Ø4 41 s |
| ↑ Ø6 (R) 49 s | → Ø8 41 s |

| Lane Group | EBL | EBT | WBL | WBT | WBR | NBL | NBT | SBL | SBT |
|------------------------|-------|--------|-------|-------|-------|-------|-------|-------|--------|
| Lane Configurations | | | | | | | | | |
| Traffic Volume (vph) | 10 | 410 | 40 | 160 | 40 | 50 | 470 | 75 | 655 |
| Future Volume (vph) | 10 | 410 | 40 | 160 | 40 | 50 | 470 | 75 | 655 |
| Lane Group Flow (vph) | 11 | 571 | 46 | 183 | 46 | 57 | 559 | 0 | 845 |
| Turn Type | Perm | NA | Perm | NA | Perm | Prot | NA | Perm | NA |
| Protected Phases | | 8 | | 4 | | 1 | 6 | | 2 |
| Permitted Phases | 8 | | 4 | | 4 | | | 2 | |
| Detector Phase | 8 | 8 | 4 | 4 | 4 | 1 | 6 | 2 | 2 |
| Switch Phase | | | | | | | | | |
| Minimum Initial (s) | 10.0 | 10.0 | 10.0 | 10.0 | 10.0 | 7.0 | 10.0 | 10.0 | 10.0 |
| Minimum Split (s) | 39.1 | 39.1 | 39.1 | 39.1 | 39.1 | 12.0 | 38.0 | 38.0 | 38.0 |
| Total Split (s) | 40.0 | 40.0 | 40.0 | 40.0 | 40.0 | 12.0 | 38.0 | 38.0 | 38.0 |
| Total Split (%) | 44.4% | 44.4% | 44.4% | 44.4% | 44.4% | 13.3% | 42.2% | 42.2% | 42.2% |
| Yellow Time (s) | 4.1 | 4.1 | 4.1 | 4.1 | 4.1 | 4.0 | 4.1 | 4.1 | 4.1 |
| All-Red Time (s) | 3.0 | 3.0 | 3.0 | 3.0 | 3.0 | 1.0 | 3.2 | 3.2 | 3.2 |
| Lost Time Adjust (s) | 0.0 | 0.0 | 0.0 | 0.0 | 0.0 | 0.0 | 0.0 | 0.0 | 0.0 |
| Total Lost Time (s) | 7.1 | 7.1 | 7.1 | 7.1 | 7.1 | 5.0 | 7.3 | | 7.3 |
| Lead/Lag | | | | | | | | | |
| Lead-Lag Optimize? | | | | | | | | | |
| Recall Mode | Ped | Ped | Ped | Ped | Ped | None | C-Max | C-Max | C-Max |
| Act Effct Green (s) | 32.9 | 32.9 | 32.9 | 32.9 | 32.9 | 7.0 | 33.1 | | 33.1 |
| Actuated g/C Ratio | 0.37 | 0.37 | 0.37 | 0.37 | 0.37 | 0.08 | 0.37 | | 0.37 |
| v/c Ratio | 0.04 | 1.22 | 0.45 | 0.35 | 0.09 | 0.50 | 0.51 | | 1.02 |
| Control Delay | 19.0 | 145.0 | 38.2 | 23.2 | 0.4 | 56.1 | 24.8 | | 53.0 |
| Queue Delay | 0.0 | 0.0 | 0.0 | 0.0 | 0.0 | 0.0 | 0.0 | | 0.0 |
| Total Delay | 19.0 | 145.0 | 38.2 | 23.2 | 0.4 | 56.1 | 24.8 | | 53.0 |
| LOS | B | F | D | C | A | E | C | | D |
| Approach Delay | | 142.7 | | 21.9 | | | 27.7 | | 53.0 |
| Approach LOS | | F | | C | | | C | | D |
| Queue Length 50th (m) | 1.2 | ~121.5 | 5.9 | 22.6 | 0.0 | 9.6 | 40.3 | | ~88.5 |
| Queue Length 95th (m) | 4.7 | #183.6 | #18.3 | 39.6 | 0.0 | #23.8 | 56.2 | | #122.1 |
| Internal Link Dist (m) | | 72.7 | | 213.1 | | | 124.0 | | 35.4 |
| Turn Bay Length (m) | 50.0 | | | | 50.0 | | | | |
| Base Capacity (vph) | 297 | 468 | 103 | 521 | 489 | 113 | 1101 | | 829 |
| Starvation Cap Reductn | 0 | 0 | 0 | 0 | 0 | 0 | 0 | | 0 |
| Spillback Cap Reductn | 0 | 0 | 0 | 0 | 0 | 0 | 0 | | 0 |
| Storage Cap Reductn | 0 | 0 | 0 | 0 | 0 | 0 | 0 | | 0 |
| Reduced v/c Ratio | 0.04 | 1.22 | 0.45 | 0.35 | 0.09 | 0.50 | 0.51 | | 1.02 |

Intersection Summary

Cycle Length: 90
 Actuated Cycle Length: 90
 Offset: 55 (61%), Referenced to phase 2:SBTL and 6:NBT, Start of Green
 Natural Cycle: 120
 Control Type: Actuated-Coordinated
 Maximum v/c Ratio: 1.22
 Intersection Signal Delay: 65.1
 Intersection Capacity Utilization 108.3%
 Analysis Period (min) 15
 ~ Volume exceeds capacity, queue is theoretically infinite.
 Queue shown is maximum after two cycles.
 # 95th percentile volume exceeds capacity, queue may be longer.
 Queue shown is maximum after two cycles.

Splits and Phases: 6: Robie & Cunard

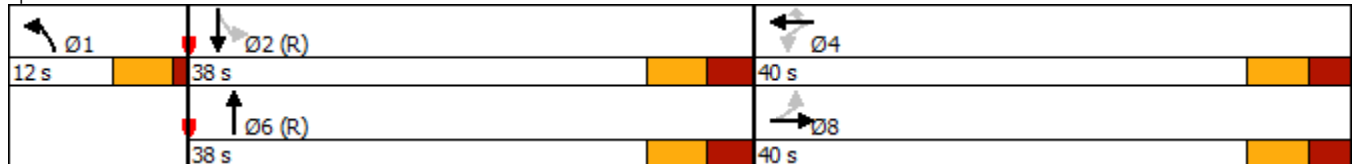

| Lane Group | EBT | EBR | EBR2 | WBT | NBL | NBT | SBL2 | SBL | SBT | NWL |
|------------------------|--------|-------|--------|-------|-------|-------|-------|--------|--------|-------|
| Lane Configurations | | | | | | | | | | |
| Traffic Volume (vph) | 410 | 470 | 400 | 205 | 150 | 405 | 68 | 240 | 730 | 245 |
| Future Volume (vph) | 410 | 470 | 400 | 205 | 150 | 405 | 68 | 240 | 730 | 245 |
| Lane Group Flow (vph) | 468 | 536 | 457 | 268 | 171 | 502 | 0 | 352 | 884 | 406 |
| Turn Type | NA | pt+ov | custom | NA | pm+pt | NA | pm+pt | pm+pt | NA | Prot |
| Protected Phases | 8 | 7 8 | | 8 | 1 | 6 | 5 | 5 | 2 | 7 |
| Permitted Phases | | | 7 | | 6 | | 2 | 2 | | |
| Minimum Split (s) | 36.0 | | 37.0 | 36.0 | 14.0 | 33.0 | 14.0 | 14.0 | 46.0 | 37.0 |
| Total Split (s) | 44.0 | | 37.0 | 44.0 | 23.0 | 46.0 | 23.0 | 23.0 | 46.0 | 37.0 |
| Total Split (%) | 29.3% | | 24.7% | 29.3% | 15.3% | 30.7% | 15.3% | 15.3% | 30.7% | 24.7% |
| Yellow Time (s) | 4.0 | | 4.0 | 4.0 | 4.0 | 4.0 | 4.0 | 4.0 | 4.0 | 4.0 |
| All-Red Time (s) | 4.0 | | 4.0 | 4.0 | 3.0 | 0.0 | 3.0 | 3.0 | 0.0 | 4.0 |
| Lost Time Adjust (s) | -1.0 | | -1.0 | -1.0 | -1.0 | -1.0 | | -1.0 | -1.0 | -1.0 |
| Total Lost Time (s) | 7.0 | | 7.0 | 7.0 | 6.0 | 3.0 | | 6.0 | 3.0 | 7.0 |
| Lead/Lag | Lag | | Lead | Lag | Lag | Lead | Lag | Lag | Lead | Lead |
| Lead-Lag Optimize? | | | | | | | | | | |
| Act Effct Green (s) | 37.0 | 74.0 | 30.0 | 37.0 | 57.0 | 43.0 | | 57.0 | 43.0 | 30.0 |
| Actuated g/C Ratio | 0.25 | 0.49 | 0.20 | 0.25 | 0.38 | 0.29 | | 0.38 | 0.29 | 0.20 |
| v/c Ratio | 1.18 | 0.79 | 1.01 | 0.37 | 0.79 | 0.61 | | 1.28 | 1.13 | 0.84 |
| Control Delay | 150.7 | 41.9 | 70.7 | 46.7 | 81.9 | 50.2 | | 193.6 | 120.9 | 74.3 |
| Queue Delay | 0.0 | 0.0 | 0.0 | 0.0 | 0.0 | 0.0 | | 0.0 | 0.0 | 0.0 |
| Total Delay | 150.7 | 41.9 | 70.7 | 46.7 | 81.9 | 50.2 | | 193.6 | 120.9 | 74.3 |
| LOS | F | D | E | D | F | D | | F | F | E |
| Approach Delay | 85.8 | | | 46.7 | | 58.2 | | | 141.6 | 74.3 |
| Approach LOS | F | | | D | | E | | | F | E |
| Queue Length 50th (m) | -165.7 | 130.0 | -73.3 | 33.6 | 37.2 | 68.3 | | -107.8 | -159.4 | 60.6 |
| Queue Length 95th (m) | #233.5 | 183.0 | #144.7 | 47.3 | #73.6 | 88.0 | | #163.0 | #201.6 | #85.9 |
| Internal Link Dist (m) | 1002.5 | | | 532.1 | | 189.5 | | | 254.3 | 700.6 |
| Turn Bay Length (m) | | 70.0 | 70.0 | | | | | | | |
| Base Capacity (vph) | 398 | 677 | 451 | 731 | 216 | 818 | | 275 | 784 | 481 |
| Starvation Cap Reductn | 0 | 0 | 0 | 0 | 0 | 0 | | 0 | 0 | 0 |
| Spillback Cap Reductn | 0 | 0 | 0 | 0 | 0 | 0 | | 0 | 0 | 0 |
| Storage Cap Reductn | 0 | 0 | 0 | 0 | 0 | 0 | | 0 | 0 | 0 |
| Reduced v/c Ratio | 1.18 | 0.79 | 1.01 | 0.37 | 0.79 | 0.61 | | 1.28 | 1.13 | 0.84 |

Intersection Summary

Cycle Length: 150
 Actuated Cycle Length: 150
 Offset: 0 (0%), Referenced to phase 2:SBTL and 6:NBTL, Start of Green
 Natural Cycle: 135
 Control Type: Pretimed
 Maximum v/c Ratio: 1.28
 Intersection Signal Delay: 94.5
 Intersection Capacity Utilization 114.2%
 Analysis Period (min) 15
 Intersection LOS: F
 ICU Level of Service H

- Volume exceeds capacity, queue is theoretically infinite.
 Queue shown is maximum after two cycles.
 # 95th percentile volume exceeds capacity, queue may be longer.
 Queue shown is maximum after two cycles.

Splits and Phases: 7: Robie & Bell & Quinpool/Cogswell

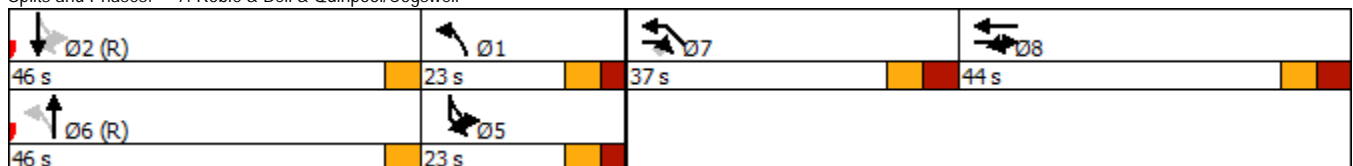

| Lane Group | EBL | EBT | WBL | WBT | WBR | NBL | NBT | SBL | SBT | SBR |
|------------------------|-------|--------|-------|-------|-------|-------|-------|-------|-------|-------|
| Lane Configurations | | | | | | | | | | |
| Traffic Volume (vph) | 65 | 275 | 20 | 105 | 95 | 45 | 510 | 195 | 905 | 20 |
| Future Volume (vph) | 65 | 275 | 20 | 105 | 95 | 45 | 510 | 195 | 905 | 20 |
| Lane Group Flow (vph) | 0 | 485 | 0 | 143 | 108 | 51 | 639 | 223 | 1033 | 23 |
| Turn Type | Perm | NA | Perm | NA | Perm | Perm | NA | pm+pt | NA | Perm |
| Protected Phases | | 8 | | 4 | | | 6 | 5 | 2 | |
| Permitted Phases | 8 | | 4 | | 4 | 6 | | 2 | | 2 |
| Detector Phase | 8 | 8 | 4 | 4 | 4 | 6 | 6 | 5 | 2 | 2 |
| Switch Phase | | | | | | | | | | |
| Minimum Initial (s) | 10.0 | 10.0 | 10.0 | 10.0 | 10.0 | 10.0 | 10.0 | 7.0 | 10.0 | 10.0 |
| Minimum Split (s) | 31.6 | 31.6 | 31.6 | 31.6 | 31.6 | 22.8 | 22.8 | 11.0 | 22.8 | 22.8 |
| Total Split (s) | 48.0 | 48.0 | 48.0 | 48.0 | 48.0 | 36.0 | 36.0 | 16.0 | 52.0 | 52.0 |
| Total Split (%) | 48.0% | 48.0% | 48.0% | 48.0% | 48.0% | 36.0% | 36.0% | 16.0% | 52.0% | 52.0% |
| Yellow Time (s) | 4.1 | 4.1 | 4.1 | 4.1 | 4.1 | 4.1 | 4.1 | 4.0 | 4.1 | 4.1 |
| All-Red Time (s) | 2.4 | 2.4 | 2.4 | 2.4 | 2.4 | 1.7 | 1.7 | 0.0 | 1.7 | 1.7 |
| Lost Time Adjust (s) | | 0.0 | | 0.0 | 0.0 | 0.0 | 0.0 | 0.0 | 0.0 | 0.0 |
| Total Lost Time (s) | | 6.5 | | 6.5 | 6.5 | 5.8 | 5.8 | 4.0 | 5.8 | 5.8 |
| Lead/Lag | | | | | | Lag | Lag | Lead | | |
| Lead-Lag Optimize? | | | | | | | | | | |
| Recall Mode | Ped | Ped | Ped | Ped | Ped | C-Max | C-Max | None | C-Max | C-Max |
| Act Effct Green (s) | | 37.1 | | 37.1 | 37.1 | 34.8 | 34.8 | 52.4 | 50.6 | 50.6 |
| Actuated g/C Ratio | | 0.37 | | 0.37 | 0.37 | 0.35 | 0.35 | 0.52 | 0.51 | 0.51 |
| v/c Ratio | | 0.90 | | 0.26 | 0.21 | 0.38 | 0.64 | 0.66 | 0.69 | 0.05 |
| Control Delay | | 49.5 | | 22.1 | 4.8 | 35.8 | 30.3 | 25.7 | 22.9 | 2.7 |
| Queue Delay | | 0.0 | | 0.0 | 0.0 | 0.0 | 0.0 | 0.0 | 0.0 | 0.0 |
| Total Delay | | 49.5 | | 22.1 | 4.8 | 35.8 | 30.3 | 25.7 | 22.9 | 2.7 |
| LOS | | D | | C | A | D | C | C | C | A |
| Approach Delay | | 49.5 | | 14.7 | | | 30.8 | | 23.1 | |
| Approach LOS | | D | | B | | | C | | C | |
| Queue Length 50th (m) | | 81.3 | | 18.2 | 0.0 | 8.9 | 67.1 | 24.6 | 81.4 | 0.0 |
| Queue Length 95th (m) | | #132.8 | | 31.1 | 9.8 | m18.6 | 85.7 | #44.6 | 109.8 | 2.6 |
| Internal Link Dist (m) | | 189.8 | | 183.6 | | | 355.1 | | 199.9 | |
| Turn Bay Length (m) | | | | | 40.0 | 50.0 | | 90.0 | | 60.0 |
| Base Capacity (vph) | | 601 | | 606 | 556 | 133 | 994 | 343 | 1493 | 467 |
| Starvation Cap Reductn | | 0 | | 0 | 0 | 0 | 0 | 0 | 0 | 0 |
| Spillback Cap Reductn | | 0 | | 0 | 0 | 0 | 0 | 0 | 0 | 0 |
| Storage Cap Reductn | | 0 | | 0 | 0 | 0 | 0 | 0 | 0 | 0 |
| Reduced v/c Ratio | | 0.81 | | 0.24 | 0.19 | 0.38 | 0.64 | 0.65 | 0.69 | 0.05 |

Intersection Summary

Cycle Length: 100
 Actuated Cycle Length: 100
 Offset: 71 (71%), Referenced to phase 2:SBTL and 6:NBTL, Start of Green
 Natural Cycle: 70
 Control Type: Actuated-Coordinated
 Maximum v/c Ratio: 0.90
 Intersection Signal Delay: 29.0
 Intersection Capacity Utilization 87.5%
 Analysis Period (min) 15
 # 95th percentile volume exceeds capacity, queue may be longer.
 Queue shown is maximum after two cycles.
 m Volume for 95th percentile queue is metered by upstream signal.

Splits and Phases: 8: Robie & Jubilee/Veterans Memorial

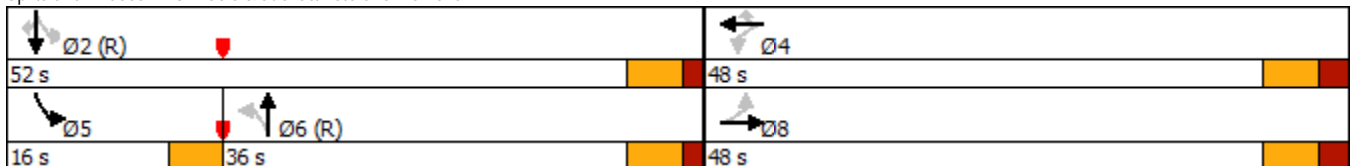

| Lane Group | EBL | EBT | WBL | WBT | NBL | NBT | NBR | SBL | SBT | SBR |
|------------------------|-------|-------|-------|-------|-------|-------|-------|-------|-------|-------|
| Lane Configurations | | | | | | | | | | |
| Traffic Volume (vph) | 45 | 170 | 45 | 150 | 50 | 420 | 25 | 215 | 750 | 50 |
| Future Volume (vph) | 45 | 170 | 45 | 150 | 50 | 420 | 25 | 215 | 750 | 50 |
| Lane Group Flow (vph) | 51 | 194 | 0 | 353 | 0 | 536 | 29 | 0 | 1101 | 57 |
| Turn Type | Perm | NA | Perm | NA | Perm | NA | Perm | pm+pt | NA | Perm |
| Protected Phases | | 4 | | 4 | | 6 | | 5 | 2 | |
| Permitted Phases | 4 | | 4 | | 6 | | 6 | 2 | | 2 |
| Minimum Split (s) | 34.0 | 34.0 | 34.0 | 34.0 | 34.5 | 34.5 | 34.5 | 13.0 | 34.5 | 34.5 |
| Total Split (s) | 34.0 | 34.0 | 34.0 | 34.0 | 52.0 | 52.0 | 52.0 | 14.0 | 66.0 | 66.0 |
| Total Split (%) | 34.0% | 34.0% | 34.0% | 34.0% | 52.0% | 52.0% | 52.0% | 14.0% | 66.0% | 66.0% |
| Yellow Time (s) | 4.1 | 4.1 | 4.1 | 4.1 | 4.1 | 4.1 | 4.1 | 4.0 | 4.1 | 4.1 |
| All-Red Time (s) | 2.4 | 2.4 | 2.4 | 2.4 | 2.4 | 2.4 | 2.4 | 0.0 | 2.4 | 2.4 |
| Lost Time Adjust (s) | 0.0 | 0.0 | | 0.0 | | 0.0 | 0.0 | | 0.0 | 0.0 |
| Total Lost Time (s) | 6.5 | 6.5 | | 6.5 | | 6.5 | 6.5 | | 6.5 | 6.5 |
| Lead/Lag | | | | | Lag | Lag | Lag | Lead | | |
| Lead-Lag Optimize? | | | | | | | | | | |
| Act Effct Green (s) | 27.5 | 27.5 | | 27.5 | | 45.5 | 45.5 | | 59.5 | 59.5 |
| Actuated g/C Ratio | 0.28 | 0.28 | | 0.28 | | 0.46 | 0.46 | | 0.60 | 0.60 |
| v/c Ratio | 0.25 | 0.42 | | 0.52 | | 0.58 | 0.07 | | 0.92 | 0.08 |
| Control Delay | 32.3 | 33.2 | | 23.1 | | 20.5 | 0.7 | | 20.8 | 0.2 |
| Queue Delay | 0.0 | 0.0 | | 0.0 | | 0.0 | 0.0 | | 0.0 | 0.0 |
| Total Delay | 32.3 | 33.2 | | 23.1 | | 20.5 | 0.7 | | 20.8 | 0.2 |
| LOS | C | C | | C | | C | A | | C | A |
| Approach Delay | | 33.0 | | 23.1 | | 19.5 | | | 19.8 | |
| Approach LOS | | C | | C | | B | | | B | |
| Queue Length 50th (m) | 7.7 | 30.8 | | 19.8 | | 23.8 | 0.0 | | 9.8 | 0.0 |
| Queue Length 95th (m) | 18.0 | 51.0 | | 33.8 | | 42.5 | 0.2 | | #22.5 | m0.0 |
| Internal Link Dist (m) | | 121.4 | | 321.4 | | 240.3 | | | 355.1 | |
| Turn Bay Length (m) | 30.0 | | | | | | 30.0 | | | 70.0 |
| Base Capacity (vph) | 204 | 457 | | 679 | | 931 | 440 | | 1196 | 714 |
| Starvation Cap Reductn | 0 | 0 | | 0 | | 0 | 0 | | 0 | 0 |
| Spillback Cap Reductn | 0 | 0 | | 0 | | 0 | 0 | | 0 | 0 |
| Storage Cap Reductn | 0 | 0 | | 0 | | 0 | 0 | | 0 | 0 |
| Reduced v/c Ratio | 0.25 | 0.42 | | 0.52 | | 0.58 | 0.07 | | 0.92 | 0.08 |

Intersection Summary

Cycle Length: 100
 Actuated Cycle Length: 100
 Offset: 94 (94%), Referenced to phase 2:SBTL and 6:NBTL, Start of Green
 Natural Cycle: 85
 Control Type: Pretimed
 Maximum v/c Ratio: 0.92
 Intersection Signal Delay: 21.6
 Intersection Capacity Utilization 122.5%
 Analysis Period (min) 15
 # 95th percentile volume exceeds capacity, queue may be longer.
 Queue shown is maximum after two cycles.
 m Volume for 95th percentile queue is metered by upstream signal.

Splits and Phases: 9: Robie & Coburg/Spring Garden

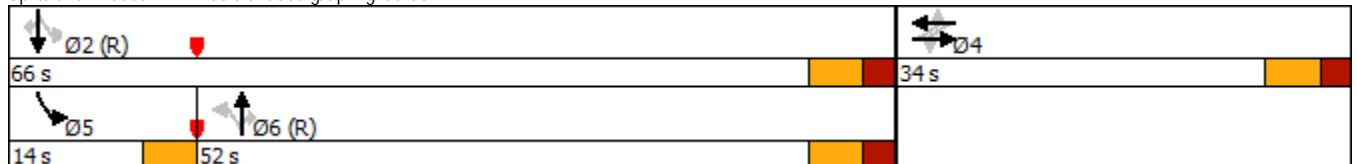

| Lane Group | EBL | EBT | WBL | WBT | WBR | NBL | NBT | NBR | SBL | SBT | SBR |
|------------------------|-------|-------|-------|-------|-------|-------|-------|-------|-------|-------|-------|
| Lane Configurations | | | | | | | | | | | |
| Traffic Volume (vph) | 30 | 145 | 30 | 85 | 95 | 10 | 310 | 40 | 345 | 455 | 50 |
| Future Volume (vph) | 30 | 145 | 30 | 85 | 95 | 10 | 310 | 40 | 345 | 455 | 50 |
| Lane Group Flow (vph) | 34 | 194 | 34 | 97 | 108 | 0 | 365 | 46 | 394 | 519 | 57 |
| Turn Type | Perm | NA | Perm | NA | Perm | Perm | NA | Perm | pm+pt | NA | Perm |
| Protected Phases | | 8 | | 4 | | | 6 | | 5 | 2 | |
| Permitted Phases | 8 | | 4 | | 4 | 6 | | 6 | 2 | | 2 |
| Detector Phase | 8 | 8 | 4 | 4 | 4 | 6 | 6 | 6 | 5 | 2 | 2 |
| Switch Phase | | | | | | | | | | | |
| Minimum Initial (s) | 10.0 | 10.0 | 10.0 | 10.0 | 10.0 | 10.0 | 10.0 | 10.0 | 7.0 | 10.0 | 10.0 |
| Minimum Split (s) | 32.5 | 32.5 | 32.5 | 32.5 | 32.5 | 43.3 | 43.3 | 43.3 | 11.0 | 43.3 | 43.3 |
| Total Split (s) | 33.0 | 33.0 | 33.0 | 33.0 | 33.0 | 46.0 | 46.0 | 46.0 | 21.0 | 67.0 | 67.0 |
| Total Split (%) | 33.0% | 33.0% | 33.0% | 33.0% | 33.0% | 46.0% | 46.0% | 46.0% | 21.0% | 67.0% | 67.0% |
| Yellow Time (s) | 4.1 | 4.1 | 4.1 | 4.1 | 4.1 | 4.1 | 4.1 | 4.1 | 4.0 | 4.1 | 4.1 |
| All-Red Time (s) | 2.4 | 2.4 | 2.4 | 2.4 | 2.4 | 3.2 | 3.2 | 3.2 | 0.0 | 3.2 | 3.2 |
| Lost Time Adjust (s) | 0.0 | 0.0 | 0.0 | 0.0 | 0.0 | | 0.0 | 0.0 | 0.0 | 0.0 | 0.0 |
| Total Lost Time (s) | 6.5 | 6.5 | 6.5 | 6.5 | 6.5 | | 7.3 | 7.3 | 4.0 | 7.3 | 7.3 |
| Lead/Lag | | | | | | Lag | Lag | Lag | Lead | | |
| Lead-Lag Optimize? | | | | | | | | | | | |
| Recall Mode | Ped | Ped | Ped | Ped | Ped | C-Max | C-Max | C-Max | None | C-Max | C-Max |
| Act Effct Green (s) | 26.0 | 26.0 | 26.0 | 26.0 | 26.0 | | 40.2 | 40.2 | 63.5 | 60.2 | 60.2 |
| Actuated g/C Ratio | 0.26 | 0.26 | 0.26 | 0.26 | 0.26 | | 0.40 | 0.40 | 0.64 | 0.60 | 0.60 |
| v/c Ratio | 0.17 | 0.53 | 0.17 | 0.26 | 0.37 | | 0.36 | 0.13 | 0.69 | 0.64 | 0.09 |
| Control Delay | 31.2 | 36.2 | 31.5 | 31.6 | 9.9 | | 20.3 | 18.0 | 10.7 | 8.2 | 3.0 |
| Queue Delay | 0.0 | 0.0 | 0.0 | 0.0 | 0.0 | | 0.0 | 0.0 | 0.0 | 0.0 | 0.0 |
| Total Delay | 31.2 | 36.2 | 31.5 | 31.6 | 9.9 | | 20.3 | 18.0 | 10.7 | 8.2 | 3.0 |
| LOS | C | D | C | C | A | | C | B | B | A | A |
| Approach Delay | | 35.5 | | 21.8 | | | 20.1 | | | 8.9 | |
| Approach LOS | | D | | C | | | C | | | A | |
| Queue Length 50th (m) | 5.1 | 30.7 | 5.1 | 14.9 | 0.0 | | 31.6 | 7.1 | 10.5 | 20.0 | 0.1 |
| Queue Length 95th (m) | 13.3 | 52.6 | 13.4 | 28.6 | 13.6 | | 25.5 | m9.2 | m18.3 | m30.4 | m1.0 |
| Internal Link Dist (m) | | 178.0 | | 171.4 | | | 167.5 | | | 240.3 | |
| Turn Bay Length (m) | 15.0 | | 15.0 | | 60.0 | | | 70.0 | | | 40.0 |
| Base Capacity (vph) | 210 | 376 | 203 | 385 | 295 | | 1005 | 348 | 582 | 816 | 633 |
| Starvation Cap Reductn | 0 | 0 | 0 | 0 | 0 | | 0 | 0 | 0 | 0 | 0 |
| Spillback Cap Reductn | 0 | 0 | 0 | 0 | 0 | | 0 | 0 | 0 | 0 | 0 |
| Storage Cap Reductn | 0 | 0 | 0 | 0 | 0 | | 0 | 0 | 0 | 0 | 0 |
| Reduced v/c Ratio | 0.16 | 0.52 | 0.17 | 0.25 | 0.37 | | 0.36 | 0.13 | 0.68 | 0.64 | 0.09 |

Intersection Summary

Cycle Length: 100
 Actuated Cycle Length: 100
 Offset: 7 (7%), Referenced to phase 2:SBTL and 6:NBT, Start of Green
 Natural Cycle: 90
 Control Type: Actuated-Coordinated
 Maximum v/c Ratio: 0.69
 Intersection Signal Delay: 16.3
 Intersection Capacity Utilization 106.8%
 Analysis Period (min) 15
 m Volume for 95th percentile queue is metered by upstream signal.

Intersection LOS: B
 ICU Level of Service G

Splits and Phases: 10: Robie & University

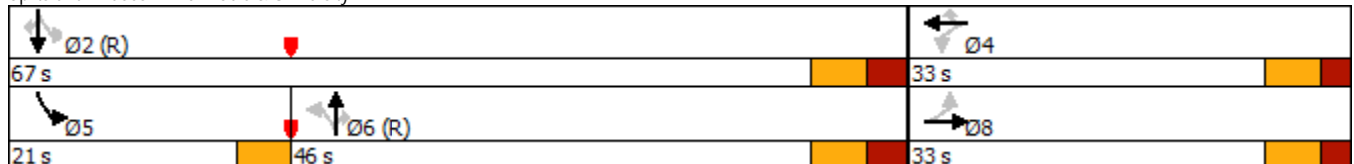

| Lane Group | EBL | EBT | WBL | WBT | NBL | NBT | NBR | SBL | SBT | SBR |
|------------------------|-------|-------|-------|-------|-------|-------|-------|-------|-------|-------|
| Lane Configurations | | | | | | | | | | |
| Traffic Volume (vph) | 50 | 290 | 10 | 135 | 25 | 225 | 30 | 175 | 275 | 40 |
| Future Volume (vph) | 50 | 290 | 10 | 135 | 25 | 225 | 30 | 175 | 275 | 40 |
| Lane Group Flow (vph) | 0 | 422 | 0 | 285 | 0 | 286 | 34 | 0 | 514 | 46 |
| Turn Type | Perm | NA | Perm | NA | Perm | NA | Perm | Perm | NA | Perm |
| Protected Phases | | 4 | | 4 | | 2 | | | 2 | |
| Permitted Phases | 4 | | 4 | | 2 | | 2 | 2 | | 2 |
| Detector Phase | 4 | 4 | 4 | 4 | 2 | 2 | 2 | 2 | 2 | 2 |
| Switch Phase | | | | | | | | | | |
| Minimum Initial (s) | 10.0 | 10.0 | 10.0 | 10.0 | 10.0 | 10.0 | 10.0 | 10.0 | 10.0 | 10.0 |
| Minimum Split (s) | 47.8 | 47.8 | 47.8 | 47.8 | 24.7 | 24.7 | 24.7 | 24.7 | 24.7 | 24.7 |
| Total Split (s) | 52.0 | 52.0 | 52.0 | 52.0 | 48.0 | 48.0 | 48.0 | 48.0 | 48.0 | 48.0 |
| Total Split (%) | 52.0% | 52.0% | 52.0% | 52.0% | 48.0% | 48.0% | 48.0% | 48.0% | 48.0% | 48.0% |
| Yellow Time (s) | 4.1 | 4.1 | 4.1 | 4.1 | 4.1 | 4.1 | 4.1 | 4.1 | 4.1 | 4.1 |
| All-Red Time (s) | 2.7 | 2.7 | 2.7 | 2.7 | 1.6 | 1.6 | 1.6 | 1.6 | 1.6 | 1.6 |
| Lost Time Adjust (s) | | 0.0 | | 0.0 | | 0.0 | 0.0 | | 0.0 | 0.0 |
| Total Lost Time (s) | | 6.8 | | 6.8 | | 5.7 | 5.7 | | 5.7 | 5.7 |
| Lead/Lag | | | | | | | | | | |
| Lead-Lag Optimize? | | | | | | | | | | |
| Recall Mode | Ped | Ped | Ped | Ped | C-Min | C-Min | C-Min | C-Min | C-Min | C-Min |
| Act Effct Green (s) | | 42.5 | | 42.5 | | 45.0 | 45.0 | | 45.0 | 45.0 |
| Actuated g/C Ratio | | 0.42 | | 0.42 | | 0.45 | 0.45 | | 0.45 | 0.45 |
| v/c Ratio | | 0.76 | | 0.45 | | 0.26 | 0.08 | | 0.63 | 0.11 |
| Control Delay | | 34.3 | | 19.1 | | 16.4 | 3.6 | | 25.0 | 4.7 |
| Queue Delay | | 0.0 | | 0.0 | | 0.0 | 0.0 | | 0.0 | 0.0 |
| Total Delay | | 34.3 | | 19.1 | | 16.4 | 3.6 | | 25.0 | 4.7 |
| LOS | | C | | B | | B | A | | C | A |
| Approach Delay | | 34.3 | | 19.1 | | 15.1 | | | 23.3 | |
| Approach LOS | | C | | B | | B | | | C | |
| Queue Length 50th (m) | | 69.0 | | 32.3 | | 15.7 | 0.0 | | 29.6 | 0.9 |
| Queue Length 95th (m) | | 101.5 | | 50.9 | | 22.4 | m3.0 | | 48.6 | m1.3 |
| Internal Link Dist (m) | | 115.5 | | 183.6 | | 422.3 | | | 167.5 | |
| Turn Bay Length (m) | | | | | | | 100.0 | | | 50.0 |
| Base Capacity (vph) | | 589 | | 673 | | 1098 | 415 | | 813 | 431 |
| Starvation Cap Reductn | | 0 | | 0 | | 0 | 0 | | 0 | 0 |
| Spillback Cap Reductn | | 0 | | 0 | | 0 | 0 | | 0 | 0 |
| Storage Cap Reductn | | 0 | | 0 | | 0 | 0 | | 0 | 0 |
| Reduced v/c Ratio | | 0.72 | | 0.42 | | 0.26 | 0.08 | | 0.63 | 0.11 |

Intersection Summary

Cycle Length: 100
 Actuated Cycle Length: 100
 Offset: 0 (0%), Referenced to phase 2:NBSB and 6:, Start of Green
 Natural Cycle: 80
 Control Type: Actuated-Coordinated
 Maximum v/c Ratio: 0.76
 Intersection Signal Delay: 23.8
 Intersection Capacity Utilization 91.8%
 Analysis Period (min) 15
 m Volume for 95th percentile queue is metered by upstream signal.

Intersection LOS: C
 ICU Level of Service F

Splits and Phases: 11: Robie & South

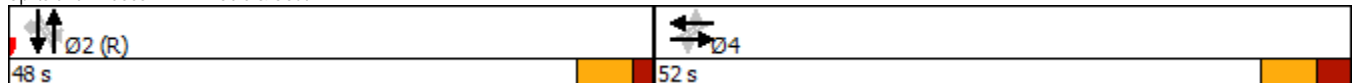

| Lane Group | EBL | EBT | WBL | WBT | WBR | NBL | NBT | SBL | SBT | SBR |
|------------------------|-------|-------|-------|-------|-------|-------|-------|-------|-------|-------|
| Lane Configurations | | | | | | | | | | |
| Traffic Volume (vph) | 20 | 260 | 65 | 185 | 170 | 10 | 40 | 210 | 105 | 20 |
| Future Volume (vph) | 20 | 260 | 65 | 185 | 170 | 10 | 40 | 210 | 105 | 20 |
| Lane Group Flow (vph) | 0 | 371 | 0 | 285 | 194 | 11 | 97 | 240 | 120 | 23 |
| Turn Type | Perm | NA | Perm | NA | Perm | Perm | NA | Perm | NA | Perm |
| Protected Phases | | 8 | | 4 | | | 6 | | 2 | |
| Permitted Phases | 8 | | 4 | | 4 | 6 | | 2 | | 2 |
| Detector Phase | 8 | 8 | 4 | 4 | 4 | 6 | 6 | 2 | 2 | 2 |
| Switch Phase | | | | | | | | | | |
| Minimum Initial (s) | 10.0 | 10.0 | 10.0 | 10.0 | 10.0 | 10.0 | 10.0 | 10.0 | 10.0 | 10.0 |
| Minimum Split (s) | 31.7 | 31.7 | 31.7 | 31.7 | 31.7 | 23.1 | 23.1 | 23.1 | 23.1 | 23.1 |
| Total Split (s) | 47.0 | 47.0 | 47.0 | 47.0 | 47.0 | 53.0 | 53.0 | 53.0 | 53.0 | 53.0 |
| Total Split (%) | 47.0% | 47.0% | 47.0% | 47.0% | 47.0% | 53.0% | 53.0% | 53.0% | 53.0% | 53.0% |
| Yellow Time (s) | 4.1 | 4.1 | 4.1 | 4.1 | 4.1 | 4.1 | 4.1 | 4.1 | 4.1 | 4.1 |
| All-Red Time (s) | 2.6 | 2.6 | 2.6 | 2.6 | 2.6 | 2.0 | 2.0 | 2.0 | 2.0 | 2.0 |
| Lost Time Adjust (s) | | 0.0 | | 0.0 | 0.0 | 0.0 | 0.0 | 0.0 | 0.0 | 0.0 |
| Total Lost Time (s) | | 6.7 | | 6.7 | 6.7 | 6.1 | 6.1 | 6.1 | 6.1 | 6.1 |
| Lead/Lag | | | | | | | | | | |
| Lead-Lag Optimize? | | | | | | | | | | |
| Recall Mode | Ped | Ped | Ped | Ped | Ped | C-Min | C-Min | C-Min | C-Min | C-Min |
| Act Effct Green (s) | | 31.2 | | 31.2 | 31.2 | 56.0 | 56.0 | 56.0 | 56.0 | 56.0 |
| Actuated g/C Ratio | | 0.31 | | 0.31 | 0.31 | 0.56 | 0.56 | 0.56 | 0.56 | 0.56 |
| v/c Ratio | | 0.77 | | 0.88 | 0.38 | 0.02 | 0.14 | 0.48 | 0.15 | 0.04 |
| Control Delay | | 40.9 | | 59.8 | 5.3 | 12.9 | 7.5 | 10.7 | 7.6 | 0.1 |
| Queue Delay | | 0.0 | | 0.0 | 0.0 | 0.0 | 0.0 | 0.0 | 0.0 | 0.0 |
| Total Delay | | 40.9 | | 59.8 | 5.3 | 12.9 | 7.5 | 10.7 | 7.6 | 0.1 |
| LOS | | D | | E | A | B | A | B | A | A |
| Approach Delay | | 40.9 | | 37.7 | | | 8.1 | | 9.1 | |
| Approach LOS | | D | | D | | | A | | A | |
| Queue Length 50th (m) | | 63.7 | | 52.6 | 0.0 | 0.9 | 3.8 | 15.5 | 7.3 | 0.0 |
| Queue Length 95th (m) | | 83.4 | | 75.6 | 12.8 | 4.2 | 13.9 | m12.3 | m6.3 | m0.0 |
| Internal Link Dist (m) | | 113.9 | | 142.4 | | | 118.8 | | 422.3 | |
| Turn Bay Length (m) | | | | | 50.0 | 20.0 | | | | 20.0 |
| Base Capacity (vph) | | 620 | | 418 | 608 | 578 | 688 | 495 | 776 | 618 |
| Starvation Cap Reductn | | 0 | | 0 | 0 | 0 | 0 | 0 | 0 | 0 |
| Spillback Cap Reductn | | 0 | | 0 | 0 | 0 | 0 | 0 | 0 | 0 |
| Storage Cap Reductn | | 0 | | 0 | 0 | 0 | 0 | 0 | 0 | 0 |
| Reduced v/c Ratio | | 0.60 | | 0.68 | 0.32 | 0.02 | 0.14 | 0.48 | 0.15 | 0.04 |

Intersection Summary

Cycle Length: 100
 Actuated Cycle Length: 100
 Offset: 28 (28%), Referenced to phase 2:SBTL and 6:NBTL, Start of Green
 Natural Cycle: 60
 Control Type: Actuated-Coordinated
 Maximum v/c Ratio: 0.88
 Intersection Signal Delay: 28.0
 Intersection Capacity Utilization 72.3%
 Analysis Period (min) 15
 m Volume for 95th percentile queue is metered by upstream signal.

Intersection LOS: C
 ICU Level of Service C

Splits and Phases: 12: Robie & Inglis

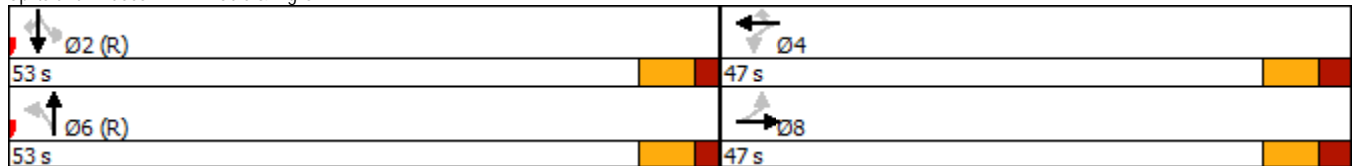

| Lane Group | EBL | EBT | WBL2 | WBT | WBR | NBL | NBT | SBL | SBT | SBR |
|------------------------|-------|-------|-------|--------|-------|-------|-------|-------|-------|--------|
| Lane Configurations | | | | | | | | | | |
| Traffic Volume (vph) | 190 | 195 | 15 | 470 | 125 | 30 | 760 | 20 | 369 | 11 |
| Future Volume (vph) | 190 | 195 | 15 | 470 | 125 | 30 | 760 | 20 | 369 | 11 |
| Lane Group Flow (vph) | 217 | 291 | 0 | 553 | 143 | 0 | 912 | 23 | 421 | 161 |
| Turn Type | pm+pt | NA | Perm | NA | Perm | Perm | NA | Perm | NA | custom |
| Protected Phases | 3 | 8 | | 4 | | | 6 | | 2 | 1 |
| Permitted Phases | 8 | | 4 | | 4 | 6 | | 2 | | 2 |
| Detector Phase | 3 | 8 | 4 | 4 | 4 | 6 | 6 | 2 | 2 | 1 |
| Switch Phase | | | | | | | | | | |
| Minimum Initial (s) | 7.0 | 10.0 | 10.0 | 10.0 | 10.0 | 10.0 | 10.0 | 10.0 | 10.0 | 4.0 |
| Minimum Split (s) | 11.0 | 50.0 | 37.0 | 37.0 | 37.0 | 40.0 | 40.0 | 40.0 | 40.0 | 8.0 |
| Total Split (s) | 13.0 | 50.0 | 37.0 | 37.0 | 37.0 | 48.0 | 48.0 | 40.0 | 40.0 | 8.0 |
| Total Split (%) | 13.3% | 51.0% | 37.8% | 37.8% | 37.8% | 49.0% | 49.0% | 40.8% | 40.8% | 8.2% |
| Yellow Time (s) | 4.0 | 4.1 | 4.1 | 4.1 | 4.1 | 4.1 | 4.1 | 4.1 | 4.1 | 3.0 |
| All-Red Time (s) | 0.0 | 2.1 | 2.1 | 2.1 | 2.1 | 1.7 | 1.7 | 1.7 | 1.7 | 0.0 |
| Lost Time Adjust (s) | 0.0 | 0.0 | | 0.0 | 0.0 | | 0.0 | 0.0 | 0.0 | 0.0 |
| Total Lost Time (s) | 4.0 | 6.2 | | 6.2 | 6.2 | | 5.8 | 5.8 | 5.8 | 3.0 |
| Lead/Lag | Lead | | Lag | Lag | Lag | | | Lag | Lag | Lead |
| Lead-Lag Optimize? | | | | | | | | | | |
| Recall Mode | None | None | None | None | None | C-Min | C-Min | C-Min | C-Min | None |
| Act Effct Green (s) | 48.7 | 46.5 | | 31.5 | 31.5 | | 39.5 | 31.4 | 31.4 | 39.3 |
| Actuated g/C Ratio | 0.50 | 0.47 | | 0.32 | 0.32 | | 0.40 | 0.32 | 0.32 | 0.40 |
| v/c Ratio | 0.80 | 0.36 | | 0.96 | 0.27 | | 0.84 | 0.17 | 0.72 | 0.27 |
| Control Delay | 43.3 | 18.4 | | 63.0 | 9.4 | | 34.2 | 26.4 | 37.1 | 4.5 |
| Queue Delay | 0.0 | 0.0 | | 0.0 | 0.0 | | 0.0 | 0.0 | 0.0 | 0.0 |
| Total Delay | 43.3 | 18.4 | | 63.0 | 9.4 | | 34.2 | 26.4 | 37.1 | 4.5 |
| LOS | D | B | | E | A | | C | C | D | A |
| Approach Delay | | 29.0 | | 52.0 | | | 34.2 | | 28.0 | |
| Approach LOS | | C | | D | | | C | | C | |
| Queue Length 50th (m) | 23.9 | 33.5 | | 103.4 | 4.5 | | 80.6 | 3.1 | 70.3 | 1.4 |
| Queue Length 95th (m) | #68.5 | 55.7 | | #169.3 | 18.1 | | 101.3 | 9.2 | 99.3 | 12.0 |
| Internal Link Dist (m) | | 253.6 | | 109.0 | | | 402.8 | | 360.9 | |
| Turn Bay Length (m) | 80.0 | | | | 50.0 | | | 180.0 | | |
| Base Capacity (vph) | 271 | 816 | | 576 | 530 | | 1162 | 149 | 636 | 600 |
| Starvation Cap Reductn | 0 | 0 | | 0 | 0 | | 0 | 0 | 0 | 0 |
| Spillback Cap Reductn | 0 | 0 | | 0 | 0 | | 0 | 0 | 0 | 0 |
| Storage Cap Reductn | 0 | 0 | | 0 | 0 | | 0 | 0 | 0 | 0 |
| Reduced v/c Ratio | 0.80 | 0.36 | | 0.96 | 0.27 | | 0.78 | 0.15 | 0.66 | 0.27 |

Intersection Summary

Cycle Length: 98
 Actuated Cycle Length: 98
 Offset: 29 (30%), Referenced to phase 2:SBTL and 6:NBTL, Start of Green
 Natural Cycle: 100
 Control Type: Actuated-Coordinated
 Maximum v/c Ratio: 0.96
 Intersection Signal Delay: 36.4
 Intersection Capacity Utilization 121.9%
 Analysis Period (min) 15
 # 95th percentile volume exceeds capacity, queue may be longer.
 Queue shown is maximum after two cycles.

Splits and Phases: 4: Robie & Almon

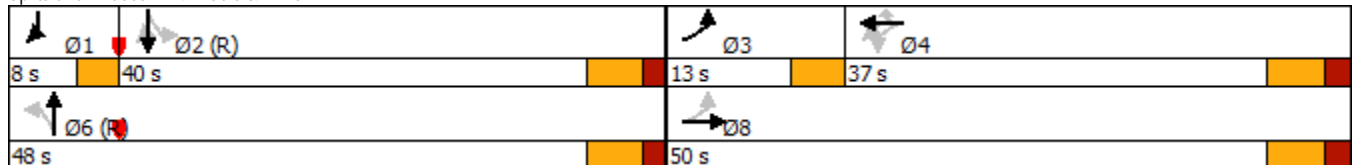

Halifax Transit Priority Corridors
5: Robie & North

| | → | ← | ↑ | ↗ | ↓ |
|------------------------|-------|--------|--------|--------|-------|
| Lane Group | EBT | WBT | NBT | NBR | SBT |
| Lane Configurations | ↗ | ↗ | ↗ | ↗ | ↗ |
| Traffic Volume (vph) | 345 | 445 | 670 | 375 | 525 |
| Future Volume (vph) | 345 | 445 | 670 | 375 | 525 |
| Lane Group Flow (vph) | 423 | 531 | 765 | 428 | 633 |
| Turn Type | NA | NA | NA | Perm | NA |
| Protected Phases | 8 | 4 | 6 | | 2 |
| Permitted Phases | | | | 6 | |
| Detector Phase | 8 | 4 | 6 | 6 | 2 |
| Switch Phase | | | | | |
| Minimum Initial (s) | 10.0 | 10.0 | 10.0 | 10.0 | 10.0 |
| Minimum Split (s) | 23.7 | 23.7 | 54.0 | 54.0 | 54.0 |
| Total Split (s) | 36.0 | 36.0 | 54.0 | 54.0 | 54.0 |
| Total Split (%) | 40.0% | 40.0% | 60.0% | 60.0% | 60.0% |
| Yellow Time (s) | 4.1 | 4.1 | 4.1 | 4.1 | 4.1 |
| All-Red Time (s) | 1.6 | 1.6 | 1.5 | 1.5 | 1.5 |
| Lost Time Adjust (s) | 0.0 | 0.0 | 0.0 | 0.0 | 0.0 |
| Total Lost Time (s) | 5.7 | 5.7 | 5.6 | 5.6 | 5.6 |
| Lead/Lag | | | | | |
| Lead-Lag Optimize? | | | | | |
| Recall Mode | Ped | Ped | C-Max | C-Max | C-Max |
| Act Effct Green (s) | 28.5 | 28.5 | 50.2 | 50.2 | 50.2 |
| Actuated g/C Ratio | 0.32 | 0.32 | 0.56 | 0.56 | 0.56 |
| v/c Ratio | 0.75 | 0.91 | 0.79 | 0.98 | 0.64 |
| Control Delay | 36.5 | 50.1 | 13.9 | 48.3 | 17.9 |
| Queue Delay | 0.0 | 0.0 | 0.0 | 0.0 | 0.0 |
| Total Delay | 36.5 | 50.1 | 13.9 | 48.3 | 17.9 |
| LOS | D | D | B | D | B |
| Approach Delay | 36.5 | 50.1 | 26.3 | | 17.9 |
| Approach LOS | D | D | C | | B |
| Queue Length 50th (m) | 62.4 | 84.0 | 130.7 | -38.3 | 73.5 |
| Queue Length 95th (m) | 95.4 | #139.1 | #179.2 | #124.9 | 110.6 |
| Internal Link Dist (m) | 171.5 | 181.9 | 446.6 | | 402.8 |
| Turn Bay Length (m) | | | | | |
| Base Capacity (vph) | 597 | 623 | 971 | 438 | 989 |
| Starvation Cap Reductn | 0 | 0 | 0 | 0 | 0 |
| Spillback Cap Reductn | 0 | 0 | 0 | 0 | 0 |
| Storage Cap Reductn | 0 | 0 | 0 | 0 | 0 |
| Reduced v/c Ratio | 0.71 | 0.85 | 0.79 | 0.98 | 0.64 |

Intersection Summary

Cycle Length: 90
 Actuated Cycle Length: 90
 Offset: 74 (82%), Referenced to phase 2:SBT and 6:NBT, Start of Green
 Natural Cycle: 90
 Control Type: Actuated-Coordinated
 Maximum v/c Ratio: 0.98
 Intersection Signal Delay: 30.5
 Intersection Capacity Utilization 81.6%
 Analysis Period (min) 15
 ~ Volume exceeds capacity, queue is theoretically infinite.
 Queue shown is maximum after two cycles.
 # 95th percentile volume exceeds capacity, queue may be longer.
 Queue shown is maximum after two cycles.

Splits and Phases: 5: Robie & North

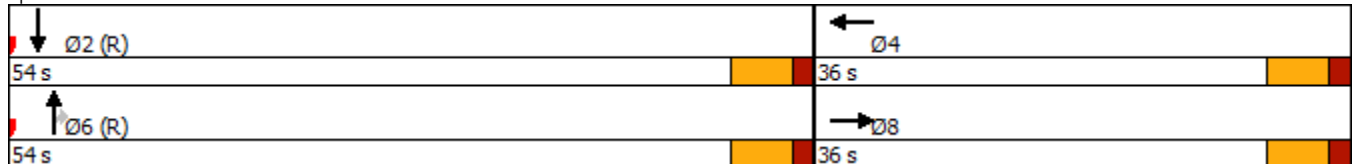

| Lane Group | EBL | EBT | WBL | WBT | WBR | NBL | NBT | SBL | SBT |
|------------------------|-------|--------|-------|--------|-------|-------|-------|-------|--------|
| Lane Configurations | | | | | | | | | |
| Traffic Volume (vph) | 20 | 300 | 65 | 475 | 75 | 50 | 760 | 55 | 545 |
| Future Volume (vph) | 20 | 300 | 65 | 475 | 75 | 50 | 760 | 55 | 545 |
| Lane Group Flow (vph) | 23 | 410 | 74 | 542 | 86 | 57 | 935 | 0 | 742 |
| Turn Type | Perm | NA | Perm | NA | Perm | Prot | NA | Perm | NA |
| Protected Phases | | 8 | | 4 | | 1 | 6 | | 2 |
| Permitted Phases | 8 | | 4 | | 4 | | | 2 | |
| Detector Phase | 8 | 8 | 4 | 4 | 4 | 1 | 6 | 2 | 2 |
| Switch Phase | | | | | | | | | |
| Minimum Initial (s) | 10.0 | 10.0 | 10.0 | 10.0 | 10.0 | 7.0 | 10.0 | 10.0 | 10.0 |
| Minimum Split (s) | 39.1 | 39.1 | 39.1 | 39.1 | 39.1 | 12.0 | 38.0 | 38.0 | 38.0 |
| Total Split (s) | 40.0 | 40.0 | 40.0 | 40.0 | 40.0 | 12.0 | 38.0 | 38.0 | 38.0 |
| Total Split (%) | 44.4% | 44.4% | 44.4% | 44.4% | 44.4% | 13.3% | 42.2% | 42.2% | 42.2% |
| Yellow Time (s) | 4.1 | 4.1 | 4.1 | 4.1 | 4.1 | 4.0 | 4.1 | 4.1 | 4.1 |
| All-Red Time (s) | 3.0 | 3.0 | 3.0 | 3.0 | 3.0 | 1.0 | 3.2 | 3.2 | 3.2 |
| Lost Time Adjust (s) | 0.0 | 0.0 | 0.0 | 0.0 | 0.0 | 0.0 | 0.0 | 0.0 | 0.0 |
| Total Lost Time (s) | 7.1 | 7.1 | 7.1 | 7.1 | 7.1 | 5.0 | 7.3 | | 7.3 |
| Lead/Lag | | | | | | | | | |
| Lead-Lag Optimize? | | | | | | | | | |
| Recall Mode | Ped | Ped | Ped | Ped | Ped | None | C-Max | C-Max | C-Max |
| Act Effct Green (s) | 32.5 | 32.5 | 32.5 | 32.5 | 32.5 | 7.0 | 33.4 | | 33.4 |
| Actuated g/C Ratio | 0.36 | 0.36 | 0.36 | 0.36 | 0.36 | 0.08 | 0.37 | | 0.37 |
| v/c Ratio | 0.21 | 0.77 | 0.32 | 0.82 | 0.15 | 0.44 | 0.74 | | 0.92 |
| Control Delay | 25.4 | 35.8 | 25.5 | 38.3 | 2.8 | 50.6 | 29.4 | | 39.7 |
| Queue Delay | 0.0 | 0.0 | 0.0 | 0.0 | 0.0 | 0.0 | 0.0 | | 0.0 |
| Total Delay | 25.4 | 35.8 | 25.5 | 38.3 | 2.8 | 50.6 | 29.4 | | 39.7 |
| LOS | C | D | C | D | A | D | C | | D |
| Approach Delay | | 35.2 | | 32.6 | | | 30.6 | | 39.7 |
| Approach LOS | | D | | C | | | C | | D |
| Queue Length 50th (m) | 2.7 | 59.4 | 9.0 | 83.3 | 0.0 | 9.6 | 75.4 | | 72.5 |
| Queue Length 95th (m) | 9.1 | #103.6 | 20.6 | #135.4 | 5.7 | 21.4 | 98.9 | | #108.6 |
| Internal Link Dist (m) | | 72.7 | | 213.1 | | | 402.3 | | 446.6 |
| Turn Bay Length (m) | 50.0 | | | | 50.0 | | | | |
| Base Capacity (vph) | 114 | 540 | 233 | 666 | 596 | 130 | 1271 | | 810 |
| Starvation Cap Reductn | 0 | 0 | 0 | 0 | 0 | 0 | 0 | | 0 |
| Spillback Cap Reductn | 0 | 0 | 0 | 0 | 0 | 0 | 0 | | 0 |
| Storage Cap Reductn | 0 | 0 | 0 | 0 | 0 | 0 | 0 | | 0 |
| Reduced v/c Ratio | 0.20 | 0.76 | 0.32 | 0.81 | 0.14 | 0.44 | 0.74 | | 0.92 |

Intersection Summary

Cycle Length: 90
 Actuated Cycle Length: 90
 Offset: 43 (48%), Referenced to phase 2:SBTL and 6:NBT, Start of Green
 Natural Cycle: 90
 Control Type: Actuated-Coordinated
 Maximum v/c Ratio: 0.92
 Intersection Signal Delay: 34.1
 Intersection Capacity Utilization 110.2%
 Analysis Period (min) 15
 # 95th percentile volume exceeds capacity, queue may be longer.
 Queue shown is maximum after two cycles.

Splits and Phases: 6: Robie & Cunard

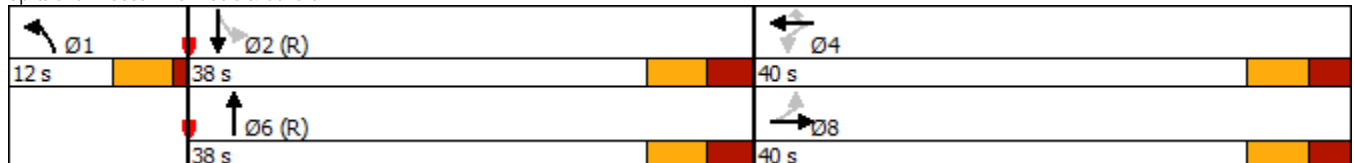

| Lane Group | EBT | EBR | EBR2 | WBT | NBL | NBT | SBL2 | SBL | SBT | NWL |
|------------------------|-------|-------|--------|--------|--------|--------|-------|--------|-------|--------|
| Lane Configurations | | | | | | | | | | |
| Traffic Volume (vph) | 215 | 295 | 140 | 565 | 245 | 775 | 70 | 140 | 560 | 625 |
| Future Volume (vph) | 215 | 295 | 140 | 565 | 245 | 775 | 70 | 140 | 560 | 625 |
| Lane Group Flow (vph) | 245 | 337 | 160 | 713 | 280 | 953 | 0 | 240 | 707 | 941 |
| Turn Type | NA | pt+ov | custom | NA | pm+pt | NA | pm+pt | pm+pt | NA | Prot |
| Protected Phases | 8 | 7 8 | | 8 | 1 | 6 | 5 | 5 | 2 | 7 |
| Permitted Phases | | | 7 | | 6 | | 2 | 2 | | |
| Minimum Split (s) | 36.0 | | 37.0 | 36.0 | 14.0 | 33.0 | 14.0 | 14.0 | 46.0 | 37.0 |
| Total Split (s) | 36.0 | | 50.0 | 36.0 | 23.0 | 46.0 | 23.0 | 23.0 | 46.0 | 50.0 |
| Total Split (%) | 23.2% | | 32.3% | 23.2% | 14.8% | 29.7% | 14.8% | 14.8% | 29.7% | 32.3% |
| Yellow Time (s) | 4.0 | | 4.0 | 4.0 | 4.0 | 4.0 | 4.0 | 4.0 | 4.0 | 4.0 |
| All-Red Time (s) | 4.0 | | 4.0 | 4.0 | 3.0 | 0.0 | 3.0 | 3.0 | 0.0 | 4.0 |
| Lost Time Adjust (s) | -1.0 | | -1.0 | -1.0 | -1.0 | -1.0 | | -1.0 | -1.0 | -1.0 |
| Total Lost Time (s) | 7.0 | | 7.0 | 7.0 | 6.0 | 3.0 | | 6.0 | 3.0 | 7.0 |
| Lead/Lag | Lag | | Lead | Lag | Lag | Lead | Lag | Lag | Lead | Lead |
| Lead-Lag Optimize? | | | | | | | | | | |
| Act Effct Green (s) | 29.0 | 79.0 | 43.0 | 29.0 | 57.0 | 43.0 | | 57.0 | 43.0 | 43.0 |
| Actuated g/C Ratio | 0.19 | 0.51 | 0.28 | 0.19 | 0.37 | 0.28 | | 0.37 | 0.28 | 0.28 |
| v/c Ratio | 0.72 | 0.43 | 0.34 | 1.12 | 1.08 | 1.07 | | 1.05 | 0.83 | 1.06 |
| Control Delay | 72.7 | 26.0 | 8.6 | 130.1 | 132.2 | 103.9 | | 132.2 | 61.9 | 99.5 |
| Queue Delay | 0.0 | 0.0 | 0.0 | 0.0 | 0.0 | 0.0 | | 0.0 | 0.0 | 0.0 |
| Total Delay | 72.7 | 26.0 | 8.6 | 130.1 | 132.2 | 103.9 | | 132.2 | 61.9 | 99.5 |
| LOS | E | C | A | F | F | F | | F | E | F |
| Approach Delay | 37.7 | | | 130.1 | | 110.3 | | | 79.7 | 99.5 |
| Approach LOS | D | | | F | | F | | | E | F |
| Queue Length 50th (m) | 71.8 | 63.8 | 0.9 | -132.3 | -72.6 | -170.7 | | -66.5 | 107.3 | -163.0 |
| Queue Length 95th (m) | 103.1 | 89.8 | 19.0 | #173.1 | #132.1 | #212.7 | | #122.7 | 132.4 | #204.1 |
| Internal Link Dist (m) | 472.7 | | | 207.4 | | 413.3 | | | 402.3 | 324.9 |
| Turn Bay Length (m) | | 70.0 | 70.0 | | 200.0 | | | | | |
| Base Capacity (vph) | 338 | 782 | 466 | 634 | 260 | 888 | | 228 | 848 | 889 |
| Starvation Cap Reductn | 0 | 0 | 0 | 0 | 0 | 0 | | 0 | 0 | 0 |
| Spillback Cap Reductn | 0 | 0 | 0 | 0 | 0 | 0 | | 0 | 0 | 0 |
| Storage Cap Reductn | 0 | 0 | 0 | 0 | 0 | 0 | | 0 | 0 | 0 |
| Reduced v/c Ratio | 0.72 | 0.43 | 0.34 | 1.12 | 1.08 | 1.07 | | 1.05 | 0.83 | 1.06 |

Intersection Summary

Cycle Length: 155
 Actuated Cycle Length: 155
 Offset: 0 (0%), Referenced to phase 2:SBTL and 6:NBTL, Start of Green
 Natural Cycle: 135
 Control Type: Pretimed
 Maximum v/c Ratio: 1.12
 Intersection Signal Delay: 93.1
 Intersection Capacity Utilization 119.3%
 Analysis Period (min) 15
 - Volume exceeds capacity, queue is theoretically infinite.
 Queue shown is maximum after two cycles.
 # 95th percentile volume exceeds capacity, queue may be longer.
 Queue shown is maximum after two cycles.

Intersection LOS: F
 ICU Level of Service H

Splits and Phases: 7: Robie & Bell & Quinpool/Cogswell

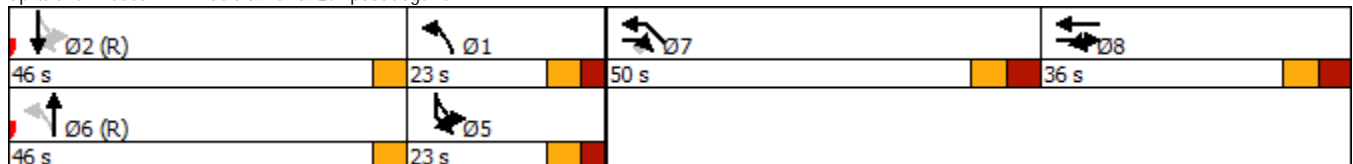

| Lane Group | EBL | EBT | WBL | WBT | WBR | NBL | NBT | SBL | SBT | SBR |
|------------------------|-------|-------|-------|-------|-------|-------|-------|-------|-------|-------|
| Lane Configurations | | | | | | | | | | |
| Traffic Volume (vph) | 60 | 135 | 15 | 340 | 120 | 160 | 740 | 105 | 625 | 30 |
| Future Volume (vph) | 60 | 135 | 15 | 340 | 120 | 160 | 740 | 105 | 625 | 30 |
| Lane Group Flow (vph) | 0 | 268 | 0 | 405 | 137 | 183 | 896 | 120 | 713 | 34 |
| Turn Type | Perm | NA | Perm | NA | Perm | pm+pt | NA | pm+pt | NA | Perm |
| Protected Phases | | 8 | | 4 | | 1 | 6 | 5 | 2 | |
| Permitted Phases | 8 | | 4 | | 4 | 6 | | 2 | | 2 |
| Detector Phase | 8 | 8 | 4 | 4 | 4 | 1 | 6 | 5 | 2 | 2 |
| Switch Phase | | | | | | | | | | |
| Minimum Initial (s) | 10.0 | 10.0 | 10.0 | 10.0 | 10.0 | 7.0 | 10.0 | 7.0 | 10.0 | 10.0 |
| Minimum Split (s) | 31.6 | 31.6 | 31.6 | 31.6 | 31.6 | 11.0 | 22.8 | 11.0 | 22.8 | 22.8 |
| Total Split (s) | 38.0 | 38.0 | 38.0 | 38.0 | 38.0 | 15.0 | 41.0 | 11.0 | 37.0 | 37.0 |
| Total Split (%) | 42.2% | 42.2% | 42.2% | 42.2% | 42.2% | 16.7% | 45.6% | 12.2% | 41.1% | 41.1% |
| Yellow Time (s) | 4.1 | 4.1 | 4.1 | 4.1 | 4.1 | 4.0 | 4.1 | 4.0 | 4.1 | 4.1 |
| All-Red Time (s) | 2.4 | 2.4 | 2.4 | 2.4 | 2.4 | 0.0 | 1.7 | 0.0 | 1.7 | 1.7 |
| Lost Time Adjust (s) | | 0.0 | | 0.0 | 0.0 | 0.0 | 0.0 | 0.0 | 0.0 | 0.0 |
| Total Lost Time (s) | | 6.5 | | 6.5 | 6.5 | 4.0 | 5.8 | 4.0 | 5.8 | 5.8 |
| Lead/Lag | | | | | | Lead | Lag | Lead | Lag | Lag |
| Lead-Lag Optimize? | | | | | | | | | | |
| Recall Mode | Ped | Ped | Ped | Ped | Ped | None | C-Max | None | C-Max | C-Max |
| Act Effct Green (s) | | 28.0 | | 28.0 | 28.0 | 49.8 | 38.3 | 45.1 | 35.9 | 35.9 |
| Actuated g/C Ratio | | 0.31 | | 0.31 | 0.31 | 0.55 | 0.43 | 0.50 | 0.40 | 0.40 |
| v/c Ratio | | 0.91 | | 0.73 | 0.27 | 0.51 | 0.66 | 0.41 | 0.54 | 0.08 |
| Control Delay | | 62.8 | | 35.8 | 6.0 | 5.2 | 14.8 | 14.6 | 23.6 | 0.3 |
| Queue Delay | | 0.0 | | 0.0 | 0.0 | 0.0 | 0.0 | 0.0 | 0.0 | 0.0 |
| Total Delay | | 62.8 | | 35.8 | 6.0 | 5.2 | 14.8 | 14.6 | 23.6 | 0.3 |
| LOS | | E | | D | A | A | B | B | C | A |
| Approach Delay | | 62.8 | | 28.3 | | | 13.2 | | 21.4 | |
| Approach LOS | | E | | C | | | B | | C | |
| Queue Length 50th (m) | | 42.8 | | 62.8 | 0.8 | 3.9 | 67.5 | 8.7 | 48.6 | 0.0 |
| Queue Length 95th (m) | | #82.0 | | 88.9 | 12.4 | m9.9 | m74.3 | 18.4 | 71.7 | 0.0 |
| Internal Link Dist (m) | | 189.8 | | 183.6 | | | 355.1 | | 413.3 | |
| Turn Bay Length (m) | | | | | 40.0 | 50.0 | | 90.0 | | 60.0 |
| Base Capacity (vph) | | 330 | | 624 | 551 | 379 | 1358 | 292 | 1315 | 453 |
| Starvation Cap Reductn | | 0 | | 0 | 0 | 0 | 0 | 0 | 0 | 0 |
| Spillback Cap Reductn | | 0 | | 0 | 0 | 0 | 0 | 0 | 0 | 0 |
| Storage Cap Reductn | | 0 | | 0 | 0 | 0 | 0 | 0 | 0 | 0 |
| Reduced v/c Ratio | | 0.81 | | 0.65 | 0.25 | 0.48 | 0.66 | 0.41 | 0.54 | 0.08 |

Intersection Summary

Cycle Length: 90
 Actuated Cycle Length: 90
 Offset: 1 (1%), Referenced to phase 2:SBTL and 6:NBT, Start of Green
 Natural Cycle: 70
 Control Type: Actuated-Coordinated
 Maximum v/c Ratio: 0.91
 Intersection Signal Delay: 23.6
 Intersection Capacity Utilization 90.1%
 Analysis Period (min) 15
 # 95th percentile volume exceeds capacity, queue may be longer.
 Queue shown is maximum after two cycles.
 m Volume for 95th percentile queue is metered by upstream signal.

Splits and Phases: 8: Robie & Jubilee/Veterans Memorial

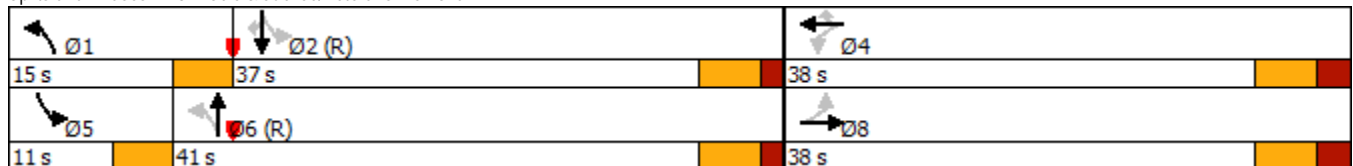

| Lane Group | EBL | EBT | WBL | WBT | NBL | NBT | NBR | SBL | SBT | SBR |
|------------------------|-------|-------|-------|-------|-------|--------|-------|-------|-------|-------|
| Lane Configurations | | | | | | | | | | |
| Traffic Volume (vph) | 55 | 135 | 40 | 315 | 160 | 730 | 30 | 120 | 385 | 35 |
| Future Volume (vph) | 55 | 135 | 40 | 315 | 160 | 730 | 30 | 120 | 385 | 35 |
| Lane Group Flow (vph) | 63 | 154 | 0 | 611 | 0 | 1016 | 34 | 0 | 576 | 40 |
| Turn Type | Perm | NA | Perm | NA | Perm | NA | Perm | pm+pt | NA | Perm |
| Protected Phases | | 4 | | 4 | | 6 | | 5 | 2 | |
| Permitted Phases | 4 | | 4 | | 6 | | 6 | 2 | | 2 |
| Minimum Split (s) | 33.5 | 33.5 | 33.5 | 33.5 | 34.5 | 34.5 | 34.5 | 13.0 | 34.5 | 34.5 |
| Total Split (s) | 34.0 | 34.0 | 34.0 | 34.0 | 43.0 | 43.0 | 43.0 | 13.0 | 56.0 | 56.0 |
| Total Split (%) | 37.8% | 37.8% | 37.8% | 37.8% | 47.8% | 47.8% | 47.8% | 14.4% | 62.2% | 62.2% |
| Yellow Time (s) | 4.1 | 4.1 | 4.1 | 4.1 | 4.1 | 4.1 | 4.1 | 4.0 | 4.1 | 4.1 |
| All-Red Time (s) | 2.4 | 2.4 | 2.4 | 2.4 | 2.4 | 2.4 | 2.4 | 0.0 | 2.4 | 2.4 |
| Lost Time Adjust (s) | 0.0 | 0.0 | | 0.0 | | 0.0 | 0.0 | | 0.0 | 0.0 |
| Total Lost Time (s) | 6.5 | 6.5 | | 6.5 | | 6.5 | 6.5 | | 6.5 | 6.5 |
| Lead/Lag | | | | | Lag | Lag | Lag | Lead | | |
| Lead-Lag Optimize? | | | | | | | | | | |
| Act Effct Green (s) | 27.5 | 27.5 | | 27.5 | | 36.5 | 36.5 | | 49.5 | 49.5 |
| Actuated g/C Ratio | 0.31 | 0.31 | | 0.31 | | 0.41 | 0.41 | | 0.55 | 0.55 |
| v/c Ratio | 0.39 | 0.27 | | 0.73 | | 1.11 | 0.08 | | 0.57 | 0.05 |
| Control Delay | 33.5 | 25.3 | | 29.0 | | 78.6 | 0.3 | | 6.9 | 0.1 |
| Queue Delay | 0.0 | 0.0 | | 0.0 | | 0.0 | 0.0 | | 0.0 | 0.0 |
| Total Delay | 33.5 | 25.3 | | 29.0 | | 78.6 | 0.3 | | 6.9 | 0.1 |
| LOS | C | C | | C | | E | A | | A | A |
| Approach Delay | | 27.7 | | 29.0 | | 76.1 | | | 6.5 | |
| Approach LOS | | C | | C | | E | | | A | |
| Queue Length 50th (m) | 8.5 | 20.0 | | 41.3 | | -109.2 | 0.0 | | 3.6 | 0.0 |
| Queue Length 95th (m) | 20.8 | 35.4 | | 60.8 | | #142.2 | m0.0 | | m18.3 | m0.0 |
| Internal Link Dist (m) | | 121.4 | | 124.9 | | 240.3 | | | 355.1 | |
| Turn Bay Length (m) | 30.0 | | | | | | 30.0 | | | 70.0 |
| Base Capacity (vph) | 161 | 563 | | 840 | | 915 | 409 | | 1012 | 737 |
| Starvation Cap Reductn | 0 | 0 | | 0 | | 0 | 0 | | 0 | 0 |
| Spillback Cap Reductn | 0 | 0 | | 0 | | 0 | 0 | | 0 | 0 |
| Storage Cap Reductn | 0 | 0 | | 0 | | 0 | 0 | | 0 | 0 |
| Reduced v/c Ratio | 0.39 | 0.27 | | 0.73 | | 1.11 | 0.08 | | 0.57 | 0.05 |

Intersection Summary

Cycle Length: 90
 Actuated Cycle Length: 90
 Offset: 36 (40%), Referenced to phase 2:SBTL and 6:NBTL, Start of Green
 Natural Cycle: 95
 Control Type: Pretimed
 Maximum v/c Ratio: 1.11
 Intersection Signal Delay: 43.1
 Intersection Capacity Utilization 116.1%
 Analysis Period (min) 15
 Intersection LOS: D
 ICU Level of Service H

- Volume exceeds capacity, queue is theoretically infinite.
 Queue shown is maximum after two cycles.
 # 95th percentile volume exceeds capacity, queue may be longer.
 Queue shown is maximum after two cycles.
 m Volume for 95th percentile queue is metered by upstream signal.

Splits and Phases: 9: Robie & Coburg/Spring Garden

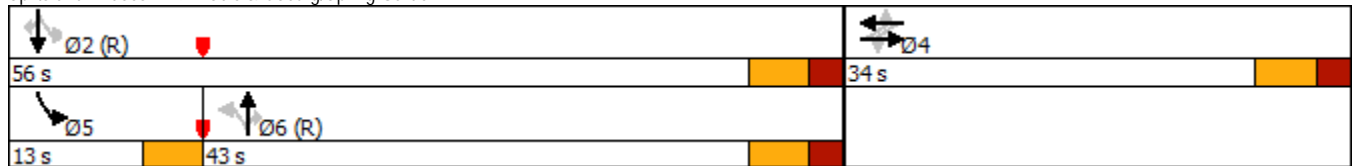

| Lane Group | EBL | EBT | WBL | WBT | WBR | NBL | NBT | NBR | SBL | SBT | SBR |
|------------------------|-------|-------|-------|-------|-------|-------|-------|-------|-------|-------|-------|
| Lane Configurations | | | | | | | | | | | |
| Traffic Volume (vph) | 45 | 100 | 25 | 145 | 225 | 30 | 670 | 30 | 135 | 270 | 45 |
| Future Volume (vph) | 45 | 100 | 25 | 145 | 225 | 30 | 670 | 30 | 135 | 270 | 45 |
| Lane Group Flow (vph) | 51 | 137 | 29 | 165 | 257 | 0 | 799 | 34 | 154 | 308 | 51 |
| Turn Type | Perm | NA | Perm | NA | Perm | Perm | NA | Perm | pm+pt | NA | Perm |
| Protected Phases | | 8 | | 4 | | | 6 | | 5 | 2 | |
| Permitted Phases | 8 | | 4 | | 4 | 6 | | 6 | 2 | | 2 |
| Detector Phase | 8 | 8 | 4 | 4 | 4 | 6 | 6 | 6 | 5 | 2 | 2 |
| Switch Phase | | | | | | | | | | | |
| Minimum Initial (s) | 10.0 | 10.0 | 10.0 | 10.0 | 10.0 | 10.0 | 10.0 | 10.0 | 7.0 | 10.0 | 10.0 |
| Minimum Split (s) | 32.5 | 32.5 | 32.5 | 32.5 | 32.5 | 43.3 | 43.3 | 43.3 | 11.0 | 43.3 | 43.3 |
| Total Split (s) | 33.0 | 33.0 | 33.0 | 33.0 | 33.0 | 44.0 | 44.0 | 44.0 | 13.0 | 57.0 | 57.0 |
| Total Split (%) | 36.7% | 36.7% | 36.7% | 36.7% | 36.7% | 48.9% | 48.9% | 48.9% | 14.4% | 63.3% | 63.3% |
| Yellow Time (s) | 4.1 | 4.1 | 4.1 | 4.1 | 4.1 | 4.1 | 4.1 | 4.1 | 4.0 | 4.1 | 4.1 |
| All-Red Time (s) | 2.4 | 2.4 | 2.4 | 2.4 | 2.4 | 3.2 | 3.2 | 3.2 | 0.0 | 3.2 | 3.2 |
| Lost Time Adjust (s) | 0.0 | 0.0 | 0.0 | 0.0 | 0.0 | | 0.0 | 0.0 | 0.0 | 0.0 | 0.0 |
| Total Lost Time (s) | 6.5 | 6.5 | 6.5 | 6.5 | 6.5 | | 7.3 | 7.3 | 4.0 | 7.3 | 7.3 |
| Lead/Lag | | | | | | Lag | Lag | Lag | Lead | | |
| Lead-Lag Optimize? | | | | | | | | | | | |
| Recall Mode | Ped | Ped | Ped | Ped | Ped | C-Max | C-Max | C-Max | None | C-Max | C-Max |
| Act Effct Green (s) | 26.1 | 26.1 | 26.1 | 26.1 | 26.1 | | 37.6 | 37.6 | 53.4 | 50.1 | 50.1 |
| Actuated g/C Ratio | 0.29 | 0.29 | 0.29 | 0.29 | 0.29 | | 0.42 | 0.42 | 0.59 | 0.56 | 0.56 |
| v/c Ratio | 0.21 | 0.30 | 0.09 | 0.35 | 0.60 | | 0.69 | 0.08 | 0.42 | 0.36 | 0.08 |
| Control Delay | 26.9 | 24.9 | 24.5 | 27.9 | 10.9 | | 22.1 | 13.5 | 16.6 | 16.6 | 9.9 |
| Queue Delay | 0.0 | 0.0 | 0.0 | 0.0 | 0.0 | | 0.0 | 0.0 | 0.0 | 0.0 | 0.0 |
| Total Delay | 26.9 | 24.9 | 24.5 | 27.9 | 10.9 | | 22.1 | 13.5 | 16.6 | 16.6 | 9.9 |
| LOS | C | C | C | C | B | | C | B | B | B | A |
| Approach Delay | | 25.4 | | 18.0 | | | 21.7 | | | 15.9 | |
| Approach LOS | | C | | B | | | C | | | B | |
| Queue Length 50th (m) | 6.6 | 16.8 | 3.7 | 22.5 | 1.9 | | 70.3 | 3.1 | 10.3 | 22.3 | 1.4 |
| Queue Length 95th (m) | 15.9 | 31.6 | 10.1 | 39.3 | 24.4 | | 51.8 | m5.5 | m29.2 | m56.0 | m6.9 |
| Internal Link Dist (m) | | 178.0 | | 171.4 | | | 167.5 | | | 240.3 | |
| Turn Bay Length (m) | 15.0 | | 15.0 | | 60.0 | | | 70.0 | | | 40.0 |
| Base Capacity (vph) | 251 | 470 | 311 | 478 | 434 | | 1154 | 428 | 380 | 844 | 657 |
| Starvation Cap Reductn | 0 | 0 | 0 | 0 | 0 | | 0 | 0 | 0 | 0 | 0 |
| Spillback Cap Reductn | 0 | 0 | 0 | 0 | 0 | | 0 | 0 | 0 | 0 | 0 |
| Storage Cap Reductn | 0 | 0 | 0 | 0 | 0 | | 0 | 0 | 0 | 0 | 0 |
| Reduced v/c Ratio | 0.20 | 0.29 | 0.09 | 0.35 | 0.59 | | 0.69 | 0.08 | 0.41 | 0.36 | 0.08 |

Intersection Summary

Cycle Length: 90
 Actuated Cycle Length: 90
 Offset: 20 (22%), Referenced to phase 2:SBTL and 6:NBTL, Start of Green
 Natural Cycle: 90
 Control Type: Actuated-Coordinated
 Maximum v/c Ratio: 0.69
 Intersection Signal Delay: 19.7
 Intersection Capacity Utilization 113.0%
 Analysis Period (min) 15
 m Volume for 95th percentile queue is metered by upstream signal.

Intersection LOS: B
 ICU Level of Service H

Splits and Phases: 10: Robie & University

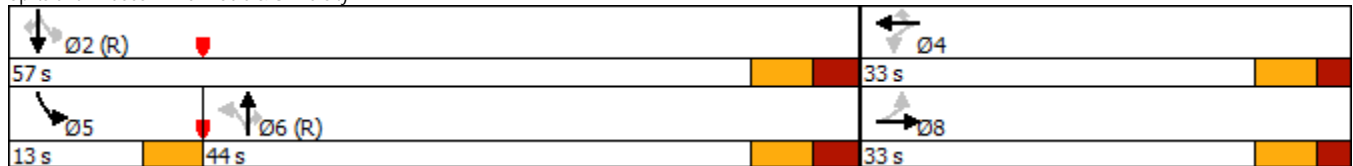

| Lane Group | EBL | EBT | WBL | WBT | NBL | NBT | NBR | SBL | SBT | SBR |
|------------------------|-------|-------|-------|-------|-------|-------|-------|-------|-------|-------|
| Lane Configurations | | | | | | | | | | |
| Traffic Volume (vph) | 55 | 205 | 20 | 345 | 45 | 330 | 15 | 95 | 195 | 50 |
| Future Volume (vph) | 55 | 205 | 20 | 345 | 45 | 330 | 15 | 95 | 195 | 50 |
| Lane Group Flow (vph) | 0 | 320 | 0 | 697 | 0 | 428 | 17 | 0 | 331 | 57 |
| Turn Type | Perm | NA | Perm | NA | Perm | NA | Perm | Perm | NA | Perm |
| Protected Phases | | 4 | | 4 | | 2 | | | 2 | |
| Permitted Phases | 4 | | 4 | | 2 | | 2 | 2 | | 2 |
| Detector Phase | 4 | 4 | 4 | 4 | 2 | 2 | 2 | 2 | 2 | 2 |
| Switch Phase | | | | | | | | | | |
| Minimum Initial (s) | 10.0 | 10.0 | 10.0 | 10.0 | 10.0 | 10.0 | 10.0 | 10.0 | 10.0 | 10.0 |
| Minimum Split (s) | 47.8 | 47.8 | 47.8 | 47.8 | 24.7 | 24.7 | 24.7 | 24.7 | 24.7 | 24.7 |
| Total Split (s) | 58.0 | 58.0 | 58.0 | 58.0 | 32.0 | 32.0 | 32.0 | 32.0 | 32.0 | 32.0 |
| Total Split (%) | 64.4% | 64.4% | 64.4% | 64.4% | 35.6% | 35.6% | 35.6% | 35.6% | 35.6% | 35.6% |
| Yellow Time (s) | 4.1 | 4.1 | 4.1 | 4.1 | 4.1 | 4.1 | 4.1 | 4.1 | 4.1 | 4.1 |
| All-Red Time (s) | 2.7 | 2.7 | 2.7 | 2.7 | 1.6 | 1.6 | 1.6 | 1.6 | 1.6 | 1.6 |
| Lost Time Adjust (s) | | 0.0 | | 0.0 | | 0.0 | 0.0 | | 0.0 | 0.0 |
| Total Lost Time (s) | | 6.8 | | 6.8 | | 5.7 | 5.7 | | 5.7 | 5.7 |
| Lead/Lag | | | | | | | | | | |
| Lead-Lag Optimize? | | | | | | | | | | |
| Recall Mode | Ped | Ped | Ped | Ped | C-Min | C-Min | C-Min | C-Min | C-Min | C-Min |
| Act Effct Green (s) | | 45.5 | | 45.5 | | 32.0 | 32.0 | | 32.0 | 32.0 |
| Actuated g/C Ratio | | 0.51 | | 0.51 | | 0.36 | 0.36 | | 0.36 | 0.36 |
| v/c Ratio | | 0.51 | | 0.81 | | 0.45 | 0.04 | | 0.47 | 0.14 |
| Control Delay | | 16.9 | | 24.8 | | 25.6 | 1.8 | | 23.3 | 6.9 |
| Queue Delay | | 0.0 | | 0.0 | | 0.0 | 0.0 | | 0.0 | 0.0 |
| Total Delay | | 16.9 | | 24.8 | | 25.6 | 1.8 | | 23.3 | 6.9 |
| LOS | | B | | C | | C | A | | C | A |
| Approach Delay | | 16.9 | | 24.8 | | 24.7 | | | 20.9 | |
| Approach LOS | | B | | C | | C | | | C | |
| Queue Length 50th (m) | | 35.6 | | 92.0 | | 30.3 | 0.0 | | 20.1 | 2.2 |
| Queue Length 95th (m) | | 48.8 | | 118.8 | | 41.5 | m0.2 | | 34.3 | 4.1 |
| Internal Link Dist (m) | | 115.5 | | 183.6 | | 422.3 | | | 167.5 | |
| Turn Bay Length (m) | | | | | | | 100.0 | | | 50.0 |
| Base Capacity (vph) | | 712 | | 961 | | 956 | 433 | | 708 | 402 |
| Starvation Cap Reductn | | 0 | | 0 | | 0 | 0 | | 0 | 0 |
| Spillback Cap Reductn | | 0 | | 0 | | 0 | 0 | | 0 | 0 |
| Storage Cap Reductn | | 0 | | 0 | | 0 | 0 | | 0 | 0 |
| Reduced v/c Ratio | | 0.45 | | 0.73 | | 0.45 | 0.04 | | 0.47 | 0.14 |

Intersection Summary

Cycle Length: 90
 Actuated Cycle Length: 90
 Offset: 22 (24%), Referenced to phase 2:NBSB and 6:, Start of Green
 Natural Cycle: 75
 Control Type: Actuated-Coordinated
 Maximum v/c Ratio: 0.81
 Intersection Signal Delay: 22.6
 Intersection Capacity Utilization 87.5%
 Analysis Period (min) 15
 m Volume for 95th percentile queue is metered by upstream signal.

Splits and Phases: 11: Robie & South



| Lane Group | EBL | EBT | WBL | WBT | WBR | NBL | NBT | SBL | SBT | SBR |
|------------------------|-------|-------|-------|-------|-------|-------|-------|-------|-------|-------|
| Lane Configurations | | | | | | | | | | |
| Traffic Volume (vph) | 20 | 235 | 80 | 275 | 275 | 30 | 125 | 175 | 70 | 15 |
| Future Volume (vph) | 20 | 235 | 80 | 275 | 275 | 30 | 125 | 175 | 70 | 15 |
| Lane Group Flow (vph) | 0 | 320 | 0 | 405 | 314 | 0 | 268 | 200 | 80 | 17 |
| Turn Type | Perm | NA | Perm | NA | Perm | Perm | NA | Perm | NA | Perm |
| Protected Phases | | 8 | | 4 | 4 | | 6 | | 2 | 2 |
| Permitted Phases | 8 | | 4 | | 4 | 6 | | 2 | | 2 |
| Detector Phase | 8 | 8 | 4 | 4 | 4 | 6 | 6 | 2 | 2 | 2 |
| Switch Phase | | | | | | | | | | |
| Minimum Initial (s) | 10.0 | 10.0 | 10.0 | 10.0 | 10.0 | 10.0 | 10.0 | 10.0 | 10.0 | 10.0 |
| Minimum Split (s) | 31.7 | 31.7 | 31.7 | 31.7 | 31.7 | 23.1 | 23.1 | 23.1 | 23.1 | 23.1 |
| Total Split (s) | 46.0 | 46.0 | 46.0 | 46.0 | 46.0 | 44.0 | 44.0 | 44.0 | 44.0 | 44.0 |
| Total Split (%) | 51.1% | 51.1% | 51.1% | 51.1% | 51.1% | 48.9% | 48.9% | 48.9% | 48.9% | 48.9% |
| Yellow Time (s) | 4.1 | 4.1 | 4.1 | 4.1 | 4.1 | 4.1 | 4.1 | 4.1 | 4.1 | 4.1 |
| All-Red Time (s) | 2.6 | 2.6 | 2.6 | 2.6 | 2.6 | 2.0 | 2.0 | 2.0 | 2.0 | 2.0 |
| Lost Time Adjust (s) | | 0.0 | | 0.0 | 0.0 | | 0.0 | 0.0 | 0.0 | 0.0 |
| Total Lost Time (s) | | 6.7 | | 6.7 | 6.7 | | 6.1 | 6.1 | 6.1 | 6.1 |
| Lead/Lag | | | | | | | | | | |
| Lead-Lag Optimize? | | | | | | | | | | |
| Recall Mode | Ped | Ped | Ped | Ped | Ped | C-Min | C-Min | C-Min | C-Min | C-Min |
| Act Effct Green (s) | | 32.4 | | 32.4 | 32.4 | | 44.8 | 44.8 | 44.8 | 44.8 |
| Actuated g/C Ratio | | 0.36 | | 0.36 | 0.36 | | 0.50 | 0.50 | 0.50 | 0.50 |
| v/c Ratio | | 0.52 | | 0.83 | 0.44 | | 0.20 | 0.45 | 0.10 | 0.03 |
| Control Delay | | 24.4 | | 41.2 | 4.1 | | 9.8 | 9.1 | 5.4 | 0.1 |
| Queue Delay | | 0.0 | | 0.0 | 0.0 | | 0.0 | 0.0 | 0.0 | 0.0 |
| Total Delay | | 24.4 | | 41.2 | 4.1 | | 9.8 | 9.1 | 5.4 | 0.1 |
| LOS | | C | | D | A | | A | A | A | A |
| Approach Delay | | 24.4 | | 25.0 | | | 9.8 | | 7.6 | |
| Approach LOS | | C | | C | | | A | | A | |
| Queue Length 50th (m) | | 41.6 | | 62.6 | 0.0 | | 8.3 | 7.4 | 2.8 | 0.0 |
| Queue Length 95th (m) | | 56.7 | | 87.0 | 13.7 | | 17.8 | m12.2 | m5.7 | m0.0 |
| Internal Link Dist (m) | | 113.9 | | 142.4 | | | 118.8 | | 422.3 | |
| Turn Bay Length (m) | | | | | 50.0 | | | | | 20.0 |
| Base Capacity (vph) | | 749 | | 592 | 800 | | 1346 | 444 | 774 | 588 |
| Starvation Cap Reductn | | 0 | | 0 | 0 | | 0 | 0 | 0 | 0 |
| Spillback Cap Reductn | | 0 | | 0 | 0 | | 0 | 0 | 0 | 0 |
| Storage Cap Reductn | | 0 | | 0 | 0 | | 0 | 0 | 0 | 0 |
| Reduced v/c Ratio | | 0.43 | | 0.68 | 0.39 | | 0.20 | 0.45 | 0.10 | 0.03 |

Intersection Summary

Cycle Length: 90
 Actuated Cycle Length: 90
 Offset: 48 (53%), Referenced to phase 2:SBTL and 6:NBTL, Start of Green
 Natural Cycle: 55
 Control Type: Actuated-Coordinated
 Maximum v/c Ratio: 0.83
 Intersection Signal Delay: 19.1
 Intersection Capacity Utilization 85.9%
 Analysis Period (min) 15
 m Volume for 95th percentile queue is metered by upstream signal.

Intersection LOS: B
 ICU Level of Service E

Splits and Phases: 12: Robie & Inglis

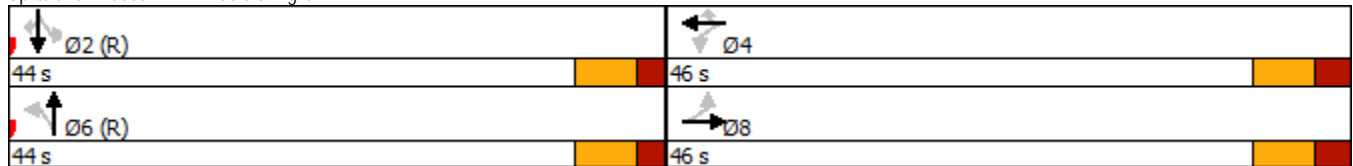









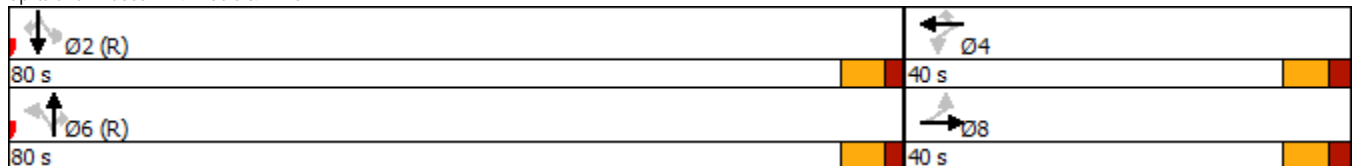



| Lane Group | EBL | EBT | WBL | WBT | WBR | NBL | NBT | NBR | SBL | SBT | SBR |
|------------------------|-------|-------|-------|-------|-------|-------|-------|-------|-------|-------|-------|
| Lane Configurations | | | | | | | | | | | |
| Traffic Volume (vph) | 150 | 290 | 20 | 195 | 45 | 30 | 456 | 15 | 40 | 573 | 205 |
| Future Volume (vph) | 150 | 290 | 20 | 195 | 45 | 30 | 456 | 15 | 40 | 573 | 205 |
| Lane Group Flow (vph) | 171 | 388 | 0 | 246 | 51 | 34 | 520 | 17 | 46 | 654 | 234 |
| Turn Type | Perm | NA | Perm | NA | Perm | Perm | NA | Perm | Perm | NA | Perm |
| Protected Phases | | 8 | | 4 | | | 6 | | | 2 | |
| Permitted Phases | 8 | | 4 | | 4 | 6 | | 6 | 2 | | 2 |
| Detector Phase | 8 | 8 | 4 | 4 | 4 | 6 | 6 | 6 | 2 | 2 | 2 |
| Switch Phase | | | | | | | | | | | |
| Minimum Initial (s) | 10.0 | 10.0 | 10.0 | 10.0 | 10.0 | 10.0 | 10.0 | 10.0 | 10.0 | 10.0 | 10.0 |
| Minimum Split (s) | 37.0 | 37.0 | 37.0 | 37.0 | 37.0 | 53.0 | 53.0 | 53.0 | 53.0 | 53.0 | 53.0 |
| Total Split (s) | 40.0 | 40.0 | 40.0 | 40.0 | 40.0 | 80.0 | 80.0 | 80.0 | 80.0 | 80.0 | 80.0 |
| Total Split (%) | 33.3% | 33.3% | 33.3% | 33.3% | 33.3% | 66.7% | 66.7% | 66.7% | 66.7% | 66.7% | 66.7% |
| Yellow Time (s) | 4.1 | 4.1 | 4.1 | 4.1 | 4.1 | 4.1 | 4.1 | 4.1 | 4.1 | 4.1 | 4.1 |
| All-Red Time (s) | 2.1 | 2.1 | 2.1 | 2.1 | 2.1 | 1.7 | 1.7 | 1.7 | 1.7 | 1.7 | 1.7 |
| Lost Time Adjust (s) | 0.0 | 0.0 | | 0.0 | 0.0 | 0.0 | 0.0 | 0.0 | 0.0 | 0.0 | 0.0 |
| Total Lost Time (s) | 6.2 | 6.2 | | 6.2 | 6.2 | 5.8 | 5.8 | 5.8 | 5.8 | 5.8 | 5.8 |
| Lead/Lag | | | | | | | | | | | |
| Lead-Lag Optimize? | | | | | | | | | | | |
| Recall Mode | None | None | None | None | None | C-Min | C-Min | C-Min | C-Min | C-Min | C-Min |
| Act Effect Green (s) | 31.9 | 31.9 | | 31.9 | 31.9 | 76.1 | 76.1 | 76.1 | 76.1 | 76.1 | 76.1 |
| Actuated g/C Ratio | 0.27 | 0.27 | | 0.27 | 0.27 | 0.63 | 0.63 | 0.63 | 0.63 | 0.63 | 0.63 |
| v/c Ratio | 0.82 | 0.84 | | 0.85 | 0.14 | 0.10 | 0.53 | 0.02 | 0.10 | 0.58 | 0.26 |
| Control Delay | 70.3 | 56.7 | | 66.9 | 9.0 | 11.2 | 15.6 | 1.8 | 7.6 | 12.2 | 1.9 |
| Queue Delay | 0.0 | 0.0 | | 0.0 | 0.0 | 0.0 | 0.0 | 0.0 | 0.0 | 0.0 | 0.0 |
| Total Delay | 70.3 | 56.7 | | 66.9 | 9.0 | 11.2 | 15.6 | 1.8 | 7.6 | 12.2 | 1.9 |
| LOS | E | E | | E | A | B | B | A | A | B | A |
| Approach Delay | | 60.9 | | 56.9 | | | 15.0 | | | 9.4 | |
| Approach LOS | | E | | E | | | B | | | A | |
| Queue Length 50th (m) | 37.4 | 84.1 | | 54.4 | 0.0 | 3.0 | 64.4 | 0.0 | 4.5 | 67.6 | 7.5 |
| Queue Length 95th (m) | #67.7 | 115.3 | | #87.6 | 9.0 | 8.3 | 103.1 | 1.9 | m1.1 | m14.2 | m0.0 |
| Internal Link Dist (m) | | 233.7 | | 226.4 | | | 402.8 | | | 360.9 | |
| Turn Bay Length (m) | 80.0 | | | | 50.0 | 30.0 | | | 180.0 | | |
| Base Capacity (vph) | 231 | 512 | | 321 | 408 | 353 | 1001 | 951 | 449 | 1146 | 925 |
| Starvation Cap Reductn | 0 | 0 | | 0 | 0 | 0 | 0 | 0 | 0 | 0 | 0 |
| Spillback Cap Reductn | 0 | 0 | | 0 | 0 | 0 | 0 | 0 | 0 | 0 | 0 |
| Storage Cap Reductn | 0 | 0 | | 0 | 0 | 0 | 0 | 0 | 0 | 0 | 0 |
| Reduced v/c Ratio | 0.74 | 0.76 | | 0.77 | 0.13 | 0.10 | 0.52 | 0.02 | 0.10 | 0.57 | 0.25 |

Intersection Summary

Cycle Length: 120
 Actuated Cycle Length: 120
 Offset: 84 (70%), Referenced to phase 2:SBTL and 6:NBTL, Start of Green
 Natural Cycle: 90
 Control Type: Actuated-Coordinated
 Maximum v/c Ratio: 0.85
 Intersection Signal Delay: 28.9
 Intersection Capacity Utilization 99.8%
 Analysis Period (min) 15
 # 95th percentile volume exceeds capacity, queue may be longer.
 Queue shown is maximum after two cycles.
 m Volume for 95th percentile queue is metered by upstream signal.

Splits and Phases: 4: Robie & Almon



| |  |  |  |  |  |  |
|------------------------|---|---|---|---|---|---|
| Lane Group | EBT | WBT | NBT | NBR | SBT | SBR |
| Lane Configurations |  |  |  |  |  |  |
| Traffic Volume (vph) | 375 | 420 | 461 | 110 | 553 | 10 |
| Future Volume (vph) | 375 | 420 | 461 | 110 | 553 | 10 |
| Lane Group Flow (vph) | 457 | 490 | 526 | 126 | 631 | 11 |
| Turn Type | NA | NA | NA | Perm | NA | Perm |
| Protected Phases | 8 | 4 | 6 | | 2 | |
| Permitted Phases | | | | 6 | | 2 |
| Detector Phase | 8 | 4 | 6 | 6 | 2 | 2 |
| Switch Phase | | | | | | |
| Minimum Initial (s) | 10.0 | 10.0 | 10.0 | 10.0 | 10.0 | 10.0 |
| Minimum Split (s) | 23.7 | 23.7 | 49.0 | 49.0 | 49.0 | 49.0 |
| Total Split (s) | 41.0 | 41.0 | 49.0 | 49.0 | 49.0 | 49.0 |
| Total Split (%) | 45.6% | 45.6% | 54.4% | 54.4% | 54.4% | 54.4% |
| Yellow Time (s) | 4.1 | 4.1 | 4.1 | 4.1 | 4.1 | 4.1 |
| All-Red Time (s) | 1.6 | 1.6 | 1.5 | 1.5 | 1.5 | 1.5 |
| Lost Time Adjust (s) | 0.0 | 0.0 | 0.0 | 0.0 | 0.0 | 0.0 |
| Total Lost Time (s) | 5.7 | 5.7 | 5.6 | 5.6 | 5.6 | 5.6 |
| Lead/Lag | | | | | | |
| Lead-Lag Optimize? | | | | | | |
| Recall Mode | Ped | Ped | C-Min | C-Min | C-Min | C-Min |
| Act Effct Green (s) | 29.6 | 29.6 | 49.1 | 49.1 | 49.1 | 49.1 |
| Actuated g/C Ratio | 0.33 | 0.33 | 0.55 | 0.55 | 0.55 | 0.55 |
| v/c Ratio | 0.85 | 0.82 | 0.60 | 0.16 | 0.64 | 0.01 |
| Control Delay | 42.8 | 39.4 | 32.9 | 14.9 | 19.4 | 0.9 |
| Queue Delay | 0.0 | 0.0 | 0.0 | 0.0 | 0.0 | 0.0 |
| Total Delay | 42.8 | 39.4 | 32.9 | 14.9 | 19.4 | 0.9 |
| LOS | D | D | C | B | B | A |
| Approach Delay | 42.8 | 39.4 | 29.4 | | 19.0 | |
| Approach LOS | D | D | C | | B | |
| Queue Length 50th (m) | 71.0 | 75.6 | 94.4 | 10.9 | 73.1 | 0.0 |
| Queue Length 95th (m) | 99.8 | 103.7 | 116.9 | m18.4 | 123.5 | 0.7 |
| Internal Link Dist (m) | 320.4 | 272.5 | 446.6 | | 402.8 | |
| Turn Bay Length (m) | | | | 50.0 | | |
| Base Capacity (vph) | 641 | 709 | 882 | 788 | 991 | 806 |
| Starvation Cap Reductn | 0 | 0 | 0 | 0 | 0 | 0 |
| Spillback Cap Reductn | 0 | 0 | 0 | 0 | 0 | 0 |
| Storage Cap Reductn | 0 | 0 | 0 | 0 | 0 | 0 |
| Reduced v/c Ratio | 0.71 | 0.69 | 0.60 | 0.16 | 0.64 | 0.01 |

Intersection Summary

Cycle Length: 90
 Actuated Cycle Length: 90
 Offset: 14 (16%), Referenced to phase 2:SBT and 6:NBT, Start of Green
 Natural Cycle: 80
 Control Type: Actuated-Coordinated
 Maximum v/c Ratio: 0.85
 Intersection Signal Delay: 31.3
 Intersection Capacity Utilization 69.6%
 Analysis Period (min) 15
 m Volume for 95th percentile queue is metered by upstream signal.

Intersection LOS: C
 ICU Level of Service C

Splits and Phases: 5: Robie & North

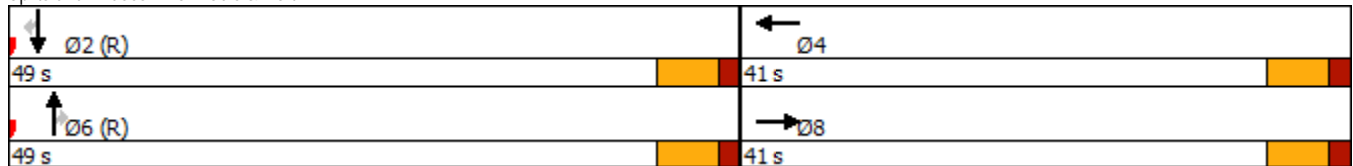

| Lane Group | EBL | EBT | WBL | WBT | WBR | NBL | NBT | NBR | SBL | SBT | SBR |
|------------------------|-------|--------|-------|-------|-------|-------|--------|-------|-------|--------|-------|
| Lane Configurations | | | | | | | | | | | |
| Traffic Volume (vph) | 10 | 410 | 40 | 160 | 40 | 50 | 461 | 20 | 75 | 643 | 10 |
| Future Volume (vph) | 10 | 410 | 40 | 160 | 40 | 50 | 461 | 20 | 75 | 643 | 10 |
| Lane Group Flow (vph) | 11 | 571 | 46 | 183 | 46 | 57 | 526 | 23 | 86 | 734 | 11 |
| Turn Type | Perm | NA | Perm | NA | Perm | Perm | NA | Perm | Perm | NA | Perm |
| Protected Phases | | 8 | | 4 | | | 6 | | | 2 | |
| Permitted Phases | 8 | | 4 | | 4 | 6 | | 6 | 2 | | 2 |
| Detector Phase | 8 | 8 | 4 | 4 | 4 | 6 | 6 | 6 | 2 | 2 | 2 |
| Switch Phase | | | | | | | | | | | |
| Minimum Initial (s) | 10.0 | 10.0 | 10.0 | 10.0 | 10.0 | 10.0 | 10.0 | 10.0 | 10.0 | 10.0 | 10.0 |
| Minimum Split (s) | 39.1 | 39.1 | 39.1 | 39.1 | 39.1 | 38.0 | 38.0 | 38.0 | 38.0 | 38.0 | 38.0 |
| Total Split (s) | 49.0 | 49.0 | 49.0 | 49.0 | 49.0 | 41.0 | 41.0 | 41.0 | 41.0 | 41.0 | 41.0 |
| Total Split (%) | 54.4% | 54.4% | 54.4% | 54.4% | 54.4% | 45.6% | 45.6% | 45.6% | 45.6% | 45.6% | 45.6% |
| Yellow Time (s) | 4.1 | 4.1 | 4.1 | 4.1 | 4.1 | 4.1 | 4.1 | 4.1 | 4.1 | 4.1 | 4.1 |
| All-Red Time (s) | 3.0 | 3.0 | 3.0 | 3.0 | 3.0 | 3.2 | 3.2 | 3.2 | 3.2 | 3.2 | 3.2 |
| Lost Time Adjust (s) | 0.0 | 0.0 | 0.0 | 0.0 | 0.0 | 0.0 | 0.0 | 0.0 | 0.0 | 0.0 | 0.0 |
| Total Lost Time (s) | 7.1 | 7.1 | 7.1 | 7.1 | 7.1 | 7.3 | 7.3 | 7.3 | 7.3 | 7.3 | 7.3 |
| Lead/Lag | | | | | | | | | | | |
| Lead-Lag Optimize? | | | | | | | | | | | |
| Recall Mode | Ped | Ped | Ped | Ped | Ped | C-Min | C-Min | C-Min | C-Min | C-Min | C-Min |
| Act Effct Green (s) | 39.3 | 39.3 | 39.3 | 39.3 | 39.3 | 36.3 | 36.3 | 36.3 | 36.3 | 36.3 | 36.3 |
| Actuated g/C Ratio | 0.44 | 0.44 | 0.44 | 0.44 | 0.44 | 0.40 | 0.40 | 0.40 | 0.40 | 0.40 | 0.40 |
| v/c Ratio | 0.03 | 0.92 | 0.23 | 0.26 | 0.08 | 0.76 | 0.74 | 0.04 | 0.45 | 1.03 | 0.02 |
| Control Delay | 13.4 | 44.5 | 18.4 | 16.5 | 4.0 | 83.8 | 31.5 | 1.8 | 34.0 | 67.9 | 3.2 |
| Queue Delay | 0.0 | 0.0 | 0.0 | 0.0 | 0.0 | 0.0 | 0.0 | 0.0 | 0.0 | 0.0 | 0.0 |
| Total Delay | 13.4 | 44.5 | 18.4 | 16.5 | 4.0 | 83.8 | 31.5 | 1.8 | 34.0 | 67.9 | 3.2 |
| LOS | B | D | B | B | A | F | C | A | C | E | A |
| Approach Delay | | 43.9 | | 14.7 | | | 35.3 | | | 63.5 | |
| Approach LOS | | D | | B | | | D | | | E | |
| Queue Length 50th (m) | 1.0 | 82.8 | 4.6 | 18.4 | 0.0 | 8.7 | 79.5 | 0.0 | 5.8 | ~145.5 | 0.0 |
| Queue Length 95th (m) | 3.8 | #146.8 | 12.2 | 31.8 | 4.9 | #31.5 | #129.7 | 1.7 | m22.7 | #207.2 | m0.0 |
| Internal Link Dist (m) | | 362.5 | | 213.1 | | | 165.3 | | | 446.6 | |
| Turn Bay Length (m) | 50.0 | | | | 50.0 | 40.0 | | 60.0 | 40.0 | | |
| Base Capacity (vph) | 412 | 662 | 209 | 742 | 598 | 75 | 714 | 593 | 193 | 714 | 660 |
| Starvation Cap Reductn | 0 | 0 | 0 | 0 | 0 | 0 | 0 | 0 | 0 | 0 | 0 |
| Spillback Cap Reductn | 0 | 0 | 0 | 0 | 0 | 0 | 0 | 0 | 0 | 0 | 0 |
| Storage Cap Reductn | 0 | 0 | 0 | 0 | 0 | 0 | 0 | 0 | 0 | 0 | 0 |
| Reduced v/c Ratio | 0.03 | 0.86 | 0.22 | 0.25 | 0.08 | 0.76 | 0.74 | 0.04 | 0.45 | 1.03 | 0.02 |

Intersection Summary

Cycle Length: 90
 Actuated Cycle Length: 90
 Offset: 20 (22%), Referenced to phase 2:SBTL and 6:NBTL, Start of Green
 Natural Cycle: 90
 Control Type: Actuated-Coordinated
 Maximum v/c Ratio: 1.03
 Intersection Signal Delay: 45.3
 Intersection Capacity Utilization 96.9%
 Analysis Period (min) 15
 ~ Volume exceeds capacity, queue is theoretically infinite.
 Queue shown is maximum after two cycles.
 # 95th percentile volume exceeds capacity, queue may be longer.
 Queue shown is maximum after two cycles.
 m Volume for 95th percentile queue is metered by upstream signal.

Splits and Phases: 6: Robie & Cunard

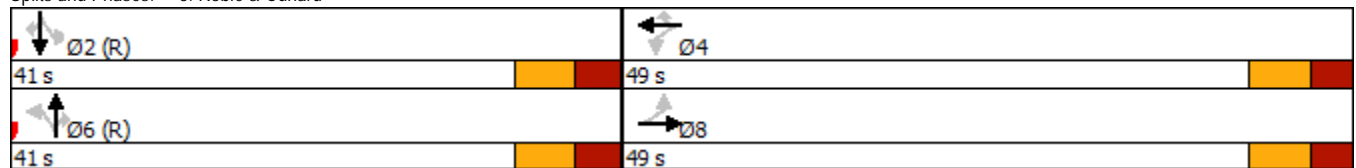

| Lane Group | EBT | EBR | EBR2 | WBT | NBL | NBT | NBR | SBL2 | SBL | SBT | SBR | NWL |
|------------------------|--------|-------|--------|-------|-------|-------|-------|-------|--------|-------|-------|-------|
| Lane Configurations | | | | | | | | | | | | |
| Traffic Volume (vph) | 410 | 470 | 400 | 205 | 150 | 390 | 25 | 68 | 240 | 710 | 45 | 245 |
| Future Volume (vph) | 410 | 470 | 400 | 205 | 150 | 390 | 25 | 68 | 240 | 710 | 45 | 245 |
| Lane Group Flow (vph) | 468 | 536 | 457 | 268 | 171 | 445 | 40 | 0 | 352 | 810 | 51 | 406 |
| Turn Type | NA | pt+ov | custom | NA | pm+pt | NA | Perm | pm+pt | pm+pt | NA | Perm | Prot |
| Protected Phases | 8 | 7 8 | | 8 | 1 | 6 | | 5 | 5 | 2 | | 7 |
| Permitted Phases | | | 7 | | 6 | | 6 | 2 | 2 | | 2 | |
| Minimum Split (s) | 36.0 | | 37.0 | 36.0 | 14.0 | 36.0 | 36.0 | 14.0 | 14.0 | 49.0 | 49.0 | 37.0 |
| Total Split (s) | 44.0 | | 37.0 | 44.0 | 14.0 | 45.0 | 45.0 | 24.0 | 24.0 | 55.0 | 55.0 | 37.0 |
| Total Split (%) | 29.3% | | 24.7% | 29.3% | 9.3% | 30.0% | 30.0% | 16.0% | 16.0% | 36.7% | 36.7% | 24.7% |
| Yellow Time (s) | 4.0 | | 4.0 | 4.0 | 4.0 | 4.0 | 4.0 | 4.0 | 4.0 | 4.0 | 4.0 | 4.0 |
| All-Red Time (s) | 4.0 | | 4.0 | 4.0 | 0.0 | 3.0 | 3.0 | 0.0 | 0.0 | 3.0 | 3.0 | 4.0 |
| Lost Time Adjust (s) | -1.0 | | -1.0 | -1.0 | -1.0 | -1.0 | 0.0 | | -1.0 | -1.0 | 0.0 | -1.0 |
| Total Lost Time (s) | 7.0 | | 7.0 | 7.0 | 3.0 | 6.0 | 7.0 | | 3.0 | 6.0 | 7.0 | 7.0 |
| Lead/Lag | Lag | | Lead | Lag | Lead | Lag | Lag | Lead | Lead | Lag | Lag | Lead |
| Lead-Lag Optimize? | | | | | | | | | | | | |
| Act Effct Green (s) | 37.0 | 74.0 | 30.0 | 37.0 | 53.0 | 39.0 | 38.0 | | 66.0 | 49.0 | 48.0 | 30.0 |
| Actuated g/C Ratio | 0.25 | 0.49 | 0.20 | 0.25 | 0.35 | 0.26 | 0.25 | | 0.44 | 0.33 | 0.32 | 0.20 |
| v/c Ratio | 1.05 | 0.71 | 0.95 | 0.33 | 0.73 | 0.51 | 0.21 | | 0.93 | 0.80 | 0.10 | 0.75 |
| Control Delay | 110.2 | 35.9 | 55.8 | 45.9 | 47.7 | 49.8 | 47.7 | | 63.9 | 53.3 | 0.4 | 66.5 |
| Queue Delay | 0.0 | 0.0 | 0.0 | 0.0 | 0.0 | 0.0 | 0.0 | | 0.0 | 0.0 | 0.0 | 0.0 |
| Total Delay | 110.2 | 35.9 | 55.8 | 45.9 | 47.7 | 49.8 | 47.7 | | 63.9 | 53.3 | 0.4 | 66.5 |
| LOS | F | D | E | D | D | D | D | | E | D | A | E |
| Approach Delay | 65.9 | | | 45.9 | | 49.1 | | | | 54.2 | | 66.5 |
| Approach LOS | E | | | D | | D | | | | D | | E |
| Queue Length 50th (m) | -151.2 | 121.7 | 66.2 | 33.3 | 31.2 | 59.8 | 9.5 | | 73.2 | 115.8 | 0.0 | 59.3 |
| Queue Length 95th (m) | #219.0 | 167.1 | #135.6 | 46.6 | #52.5 | 77.3 | 20.6 | | #117.7 | 141.5 | 0.0 | 78.2 |
| Internal Link Dist (m) | 932.3 | | | 207.4 | | 413.3 | | | | 213.0 | | 150.4 |
| Turn Bay Length (m) | | 70.0 | 70.0 | | 100.0 | | | | 150.0 | | | |
| Base Capacity (vph) | 445 | 757 | 480 | 816 | 233 | 875 | 193 | | 378 | 1009 | 486 | 538 |
| Starvation Cap Reductn | 0 | 0 | 0 | 0 | 0 | 0 | 0 | | 0 | 0 | 0 | 0 |
| Spillback Cap Reductn | 0 | 0 | 0 | 0 | 0 | 0 | 0 | | 0 | 0 | 0 | 0 |
| Storage Cap Reductn | 0 | 0 | 0 | 0 | 0 | 0 | 0 | | 0 | 0 | 0 | 0 |
| Reduced v/c Ratio | 1.05 | 0.71 | 0.95 | 0.33 | 0.73 | 0.51 | 0.21 | | 0.93 | 0.80 | 0.10 | 0.75 |

Intersection Summary

Cycle Length: 150
 Actuated Cycle Length: 150
 Offset: 0 (0%), Referenced to phase 2:SBTL and 6:NBTL, Start of Green
 Natural Cycle: 140
 Control Type: Pretimed
 Maximum v/c Ratio: 1.05
 Intersection Signal Delay: 58.3
 Intersection Capacity Utilization 111.2%
 Analysis Period (min) 15
 - Volume exceeds capacity, queue is theoretically infinite.
 Queue shown is maximum after two cycles.
 # 95th percentile volume exceeds capacity, queue may be longer.
 Queue shown is maximum after two cycles.

Splits and Phases: 7: Robie & Bell & Quinpool/Cogswell

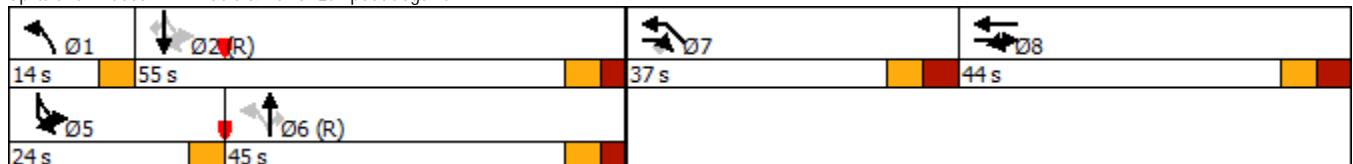

| Lane Group | EBL | EBT | WBL | WBT | WBR | NBL | NBT | NBR | SBL | SBT | SBR |
|------------------------|-------|-------|-------|-------|-------|-------|-------|-------|-------|-------|-------|
| Lane Configurations | | | | | | | | | | | |
| Traffic Volume (vph) | 65 | 275 | 20 | 105 | 95 | 45 | 495 | 50 | 195 | 885 | 20 |
| Future Volume (vph) | 65 | 275 | 20 | 105 | 95 | 45 | 495 | 50 | 195 | 885 | 20 |
| Lane Group Flow (vph) | 0 | 485 | 0 | 143 | 108 | 51 | 565 | 57 | 223 | 1010 | 23 |
| Turn Type | Perm | NA | Perm | NA | Perm | Perm | NA | Perm | pm+pt | NA | Perm |
| Protected Phases | | 8 | | 4 | | | 6 | | 5 | 2 | |
| Permitted Phases | 8 | | 4 | | 4 | 6 | | 6 | 2 | | 2 |
| Detector Phase | 8 | 8 | 4 | 4 | 4 | 6 | 6 | 6 | 5 | 2 | 2 |
| Switch Phase | | | | | | | | | | | |
| Minimum Initial (s) | 10.0 | 10.0 | 10.0 | 10.0 | 10.0 | 10.0 | 10.0 | 10.0 | 8.0 | 10.0 | 10.0 |
| Minimum Split (s) | 31.6 | 31.6 | 31.6 | 31.6 | 31.6 | 22.8 | 22.8 | 22.8 | 13.0 | 22.8 | 22.8 |
| Total Split (s) | 45.0 | 45.0 | 45.0 | 45.0 | 45.0 | 62.0 | 62.0 | 62.0 | 13.0 | 75.0 | 75.0 |
| Total Split (%) | 37.5% | 37.5% | 37.5% | 37.5% | 37.5% | 51.7% | 51.7% | 51.7% | 10.8% | 62.5% | 62.5% |
| Yellow Time (s) | 4.1 | 4.1 | 4.1 | 4.1 | 4.1 | 4.1 | 4.1 | 4.1 | 4.0 | 4.1 | 4.1 |
| All-Red Time (s) | 2.4 | 2.4 | 2.4 | 2.4 | 2.4 | 1.7 | 1.7 | 1.7 | 0.0 | 1.7 | 1.7 |
| Lost Time Adjust (s) | | 0.0 | | 0.0 | 0.0 | 0.0 | 0.0 | 0.0 | 0.0 | 0.0 | 0.0 |
| Total Lost Time (s) | | 6.5 | | 6.5 | 6.5 | 5.8 | 5.8 | 5.8 | 4.0 | 5.8 | 5.8 |
| Lead/Lag | | | | | | Lag | Lag | Lag | Lead | | |
| Lead-Lag Optimize? | | | | | | | | | | | |
| Recall Mode | Ped | Ped | Ped | Ped | Ped | C-Min | C-Min | C-Min | None | C-Min | C-Min |
| Act Effct Green (s) | | 42.3 | | 42.3 | 42.3 | 49.1 | 49.1 | 49.1 | 67.2 | 65.4 | 65.4 |
| Actuated g/C Ratio | | 0.35 | | 0.35 | 0.35 | 0.41 | 0.41 | 0.41 | 0.56 | 0.54 | 0.54 |
| v/c Ratio | | 0.86 | | 0.25 | 0.20 | 0.29 | 0.42 | 0.11 | 0.53 | 0.56 | 0.04 |
| Control Delay | | 50.5 | | 27.9 | 5.4 | 35.2 | 32.0 | 11.8 | 19.6 | 20.1 | 3.7 |
| Queue Delay | | 0.0 | | 0.0 | 0.0 | 0.0 | 0.0 | 0.0 | 0.0 | 0.0 | 0.0 |
| Total Delay | | 50.5 | | 27.9 | 5.4 | 35.2 | 32.0 | 11.8 | 19.6 | 20.1 | 3.7 |
| LOS | | D | | C | A | D | C | B | B | C | A |
| Approach Delay | | 50.5 | | 18.2 | | | 30.5 | | | 19.7 | |
| Approach LOS | | D | | B | | | C | | | B | |
| Queue Length 50th (m) | | 100.5 | | 23.2 | 0.0 | 9.3 | 54.9 | 2.1 | 26.5 | 81.7 | 0.0 |
| Queue Length 95th (m) | | 140.4 | | 37.5 | 11.2 | m21.8 | 80.2 | m11.4 | 43.1 | 105.8 | 3.1 |
| Internal Link Dist (m) | | 189.8 | | 183.6 | | | 355.1 | | | 413.3 | |
| Turn Bay Length (m) | | | | | 40.0 | 50.0 | | | 90.0 | | |
| Base Capacity (vph) | | 577 | | 577 | 535 | 202 | 1552 | 598 | 421 | 1923 | 555 |
| Starvation Cap Reductn | | 0 | | 0 | 0 | 0 | 0 | 0 | 0 | 0 | 0 |
| Spillback Cap Reductn | | 0 | | 0 | 0 | 0 | 0 | 0 | 0 | 0 | 0 |
| Storage Cap Reductn | | 0 | | 0 | 0 | 0 | 0 | 0 | 0 | 0 | 0 |
| Reduced v/c Ratio | | 0.84 | | 0.25 | 0.20 | 0.25 | 0.36 | 0.10 | 0.53 | 0.53 | 0.04 |

Intersection Summary

Cycle Length: 120
 Actuated Cycle Length: 120
 Offset: 43 (36%), Referenced to phase 2:SBTL and 6:NBTL, Start of Green
 Natural Cycle: 70
 Control Type: Actuated-Coordinated
 Maximum v/c Ratio: 0.86
 Intersection Signal Delay: 27.9
 Intersection Capacity Utilization 80.9%
 Analysis Period (min) 15
 m Volume for 95th percentile queue is metered by upstream signal.

Splits and Phases: 8: Robie & Jubilee/Veterans Memorial

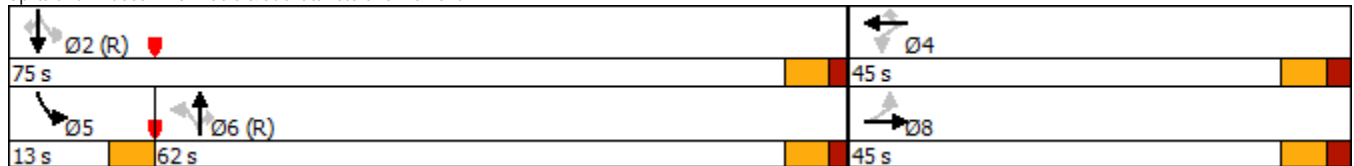

| Lane Group | EBL | EBT | WBL | WBT | NBL | NBT | NBR | SBL | SBT | SBR |
|------------------------|-------|-------|-------|-------|-------|-------|-------|-------|-------|-------|
| Lane Configurations | | | | | | | | | | |
| Traffic Volume (vph) | 45 | 170 | 45 | 150 | 50 | 409 | 25 | 215 | 741 | 50 |
| Future Volume (vph) | 45 | 170 | 45 | 150 | 50 | 409 | 25 | 215 | 741 | 50 |
| Lane Group Flow (vph) | 51 | 194 | 0 | 353 | 57 | 467 | 29 | 245 | 846 | 57 |
| Turn Type | Perm | NA | Perm | NA | Perm | NA | Perm | pm+pt | NA | Perm |
| Protected Phases | | 4 | | 4 | | 2 | | 1 | 6 | |
| Permitted Phases | 4 | | 4 | | 2 | | 2 | 6 | | 6 |
| Detector Phase | 4 | 4 | 4 | 4 | 2 | 2 | 2 | 1 | 6 | 6 |
| Switch Phase | | | | | | | | | | |
| Minimum Initial (s) | 10.0 | 10.0 | 10.0 | 10.0 | 10.0 | 10.0 | 10.0 | 8.0 | 10.0 | 10.0 |
| Minimum Split (s) | 34.0 | 34.0 | 34.0 | 34.0 | 34.5 | 34.5 | 34.5 | 13.0 | 34.5 | 34.5 |
| Total Split (s) | 34.0 | 34.0 | 34.0 | 34.0 | 69.0 | 69.0 | 69.0 | 17.0 | 86.0 | 86.0 |
| Total Split (%) | 28.3% | 28.3% | 28.3% | 28.3% | 57.5% | 57.5% | 57.5% | 14.2% | 71.7% | 71.7% |
| Yellow Time (s) | 4.1 | 4.1 | 4.1 | 4.1 | 4.1 | 4.1 | 4.1 | 4.0 | 4.1 | 4.1 |
| All-Red Time (s) | 2.4 | 2.4 | 2.4 | 2.4 | 2.4 | 2.4 | 2.4 | 1.0 | 2.4 | 2.4 |
| Lost Time Adjust (s) | 0.0 | 0.0 | | 0.0 | 0.0 | 0.0 | 0.0 | 0.0 | 0.0 | 0.0 |
| Total Lost Time (s) | 6.5 | 6.5 | | 6.5 | 6.5 | 6.5 | 6.5 | 5.0 | 6.5 | 6.5 |
| Lead/Lag | | | | | Lag | Lag | Lag | Lead | | |
| Lead-Lag Optimize? | | | | | | | | | | |
| Recall Mode | None | None | None | None | C-Min | C-Min | C-Min | None | C-Min | C-Min |
| Act Effct Green (s) | 21.0 | 21.0 | | 21.0 | 70.3 | 70.3 | 70.3 | 87.5 | 86.0 | 86.0 |
| Actuated g/C Ratio | 0.18 | 0.18 | | 0.18 | 0.59 | 0.59 | 0.59 | 0.73 | 0.72 | 0.72 |
| v/c Ratio | 0.44 | 0.60 | | 0.82 | 0.18 | 0.25 | 0.03 | 0.41 | 0.69 | 0.06 |
| Control Delay | 54.2 | 52.3 | | 50.3 | 14.7 | 11.4 | 4.5 | 10.9 | 23.8 | 5.3 |
| Queue Delay | 0.0 | 0.0 | | 0.0 | 0.0 | 0.0 | 0.0 | 0.0 | 0.0 | 0.0 |
| Total Delay | 54.2 | 52.3 | | 50.3 | 14.7 | 11.4 | 4.5 | 10.9 | 23.8 | 5.3 |
| LOS | D | D | | D | B | B | A | B | C | A |
| Approach Delay | | 52.7 | | 50.3 | | 11.4 | | | 20.1 | |
| Approach LOS | | D | | D | | B | | | C | |
| Queue Length 50th (m) | 10.7 | 42.1 | | 31.4 | 2.4 | 10.5 | 0.0 | 21.2 | 188.9 | 2.1 |
| Queue Length 95th (m) | 22.5 | 62.0 | | 46.5 | 21.2 | 58.3 | 4.9 | m65.7 | 242.7 | m12.8 |
| Internal Link Dist (m) | | 121.4 | | 435.9 | | 240.3 | | | 355.1 | |
| Turn Bay Length (m) | 30.0 | | | | 60.0 | | 30.0 | | | 70.0 |
| Base Capacity (vph) | 153 | 426 | | 533 | 324 | 1848 | 963 | 611 | 1233 | 923 |
| Starvation Cap Reductn | 0 | 0 | | 0 | 0 | 0 | 0 | 0 | 0 | 0 |
| Spillback Cap Reductn | 0 | 0 | | 0 | 0 | 0 | 0 | 0 | 0 | 0 |
| Storage Cap Reductn | 0 | 0 | | 0 | 0 | 0 | 0 | 0 | 0 | 0 |
| Reduced v/c Ratio | 0.33 | 0.46 | | 0.66 | 0.18 | 0.25 | 0.03 | 0.40 | 0.69 | 0.06 |

Intersection Summary

Cycle Length: 120
 Actuated Cycle Length: 120
 Offset: 104 (87%), Referenced to phase 2:NBT and 6:SBTL, Start of Green
 Natural Cycle: 85
 Control Type: Actuated-Coordinated
 Maximum v/c Ratio: 0.82
 Intersection Signal Delay: 26.1
 Intersection Capacity Utilization 114.5%
 Analysis Period (min) 15
 m Volume for 95th percentile queue is metered by upstream signal.

Splits and Phases: 9: Robie & Coburg/Spring Garden

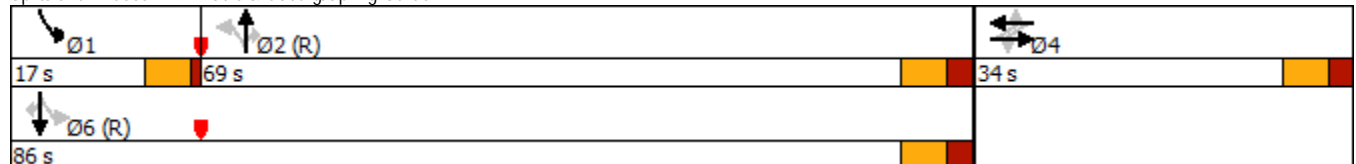

| Lane Group | EBL | EBT | WBL | WBT | WBR | NBL | NBT | NBR | SBL | SBT | SBR |
|------------------------|-------|-------|-------|-------|-------|-------|-------|-------|-------|-------|-------|
| Lane Configurations | | | | | | | | | | | |
| Traffic Volume (vph) | 30 | 145 | 30 | 85 | 95 | 10 | 301 | 40 | 345 | 449 | 50 |
| Future Volume (vph) | 30 | 145 | 30 | 85 | 95 | 10 | 301 | 40 | 345 | 449 | 50 |
| Lane Group Flow (vph) | 34 | 194 | 34 | 97 | 108 | 11 | 344 | 46 | 394 | 512 | 57 |
| Turn Type | Perm | NA | Perm | NA | Perm | Perm | NA | Perm | pm+pt | NA | Perm |
| Protected Phases | | 8 | | 4 | | | 6 | | 5 | 2 | |
| Permitted Phases | 8 | | 4 | | 4 | 6 | | 6 | 2 | | 2 |
| Detector Phase | 8 | 8 | 4 | 4 | 4 | 6 | 6 | 6 | 5 | 2 | 2 |
| Switch Phase | | | | | | | | | | | |
| Minimum Initial (s) | 10.0 | 10.0 | 10.0 | 10.0 | 10.0 | 10.0 | 10.0 | 10.0 | 7.0 | 10.0 | 10.0 |
| Minimum Split (s) | 32.5 | 32.5 | 32.5 | 32.5 | 32.5 | 43.3 | 43.3 | 43.3 | 11.0 | 43.3 | 43.3 |
| Total Split (s) | 38.0 | 38.0 | 38.0 | 38.0 | 38.0 | 53.0 | 53.0 | 53.0 | 29.0 | 82.0 | 82.0 |
| Total Split (%) | 31.7% | 31.7% | 31.7% | 31.7% | 31.7% | 44.2% | 44.2% | 44.2% | 24.2% | 68.3% | 68.3% |
| Yellow Time (s) | 4.1 | 4.1 | 4.1 | 4.1 | 4.1 | 4.1 | 4.1 | 4.1 | 4.0 | 4.1 | 4.1 |
| All-Red Time (s) | 2.4 | 2.4 | 2.4 | 2.4 | 2.4 | 3.2 | 3.2 | 3.2 | 0.0 | 3.2 | 3.2 |
| Lost Time Adjust (s) | 0.0 | 0.0 | 0.0 | 0.0 | 0.0 | 0.0 | 0.0 | 0.0 | 0.0 | 0.0 | 0.0 |
| Total Lost Time (s) | 6.5 | 6.5 | 6.5 | 6.5 | 6.5 | 7.3 | 7.3 | 7.3 | 4.0 | 7.3 | 7.3 |
| Lead/Lag | | | | | | Lag | Lag | Lag | Lead | | |
| Lead-Lag Optimize? | | | | | | | | | | | |
| Recall Mode | Ped | Ped | Ped | Ped | Ped | C-Min | C-Min | C-Min | None | C-Min | C-Min |
| Act Effct Green (s) | 26.2 | 26.2 | 26.2 | 26.2 | 26.2 | 59.3 | 59.3 | 59.3 | 83.3 | 80.0 | 80.0 |
| Actuated g/C Ratio | 0.22 | 0.22 | 0.22 | 0.22 | 0.22 | 0.49 | 0.49 | 0.49 | 0.69 | 0.67 | 0.67 |
| v/c Ratio | 0.18 | 0.56 | 0.20 | 0.27 | 0.39 | 0.03 | 0.23 | 0.06 | 0.59 | 0.51 | 0.05 |
| Control Delay | 40.9 | 47.3 | 42.0 | 41.3 | 11.5 | 9.6 | 12.4 | 3.0 | 14.0 | 15.8 | 6.8 |
| Queue Delay | 0.0 | 0.0 | 0.0 | 0.0 | 0.0 | 0.0 | 0.0 | 0.0 | 0.0 | 0.0 | 0.0 |
| Total Delay | 40.9 | 47.3 | 42.0 | 41.3 | 11.5 | 9.6 | 12.4 | 3.0 | 14.0 | 15.8 | 6.8 |
| LOS | D | D | D | D | B | A | B | A | B | B | A |
| Approach Delay | | 46.4 | | 28.0 | | | 11.2 | | | 14.5 | |
| Approach LOS | | D | | C | | | B | | | B | |
| Queue Length 50th (m) | 6.6 | 39.6 | 6.6 | 19.2 | 0.0 | 1.4 | 25.0 | 1.7 | 27.4 | 44.3 | 1.6 |
| Queue Length 95th (m) | 15.7 | 62.8 | 15.9 | 34.1 | 15.4 | m1.8 | 23.3 | m2.2 | 0.0 | 152.4 | m7.1 |
| Internal Link Dist (m) | | 178.0 | | 171.4 | | | 167.5 | | | 240.3 | |
| Turn Bay Length (m) | 15.0 | | 15.0 | | 60.0 | 60.0 | | 70.0 | 60.0 | | 40.0 |
| Base Capacity (vph) | 227 | 413 | 200 | 426 | 312 | 395 | 1479 | 796 | 736 | 1010 | 1054 |
| Starvation Cap Reductn | 0 | 0 | 0 | 0 | 0 | 0 | 0 | 0 | 0 | 0 | 0 |
| Spillback Cap Reductn | 0 | 0 | 0 | 0 | 0 | 0 | 0 | 0 | 0 | 0 | 0 |
| Storage Cap Reductn | 0 | 0 | 0 | 0 | 0 | 0 | 0 | 0 | 0 | 0 | 0 |
| Reduced v/c Ratio | 0.15 | 0.47 | 0.17 | 0.23 | 0.35 | 0.03 | 0.23 | 0.06 | 0.54 | 0.51 | 0.05 |

Intersection Summary

Cycle Length: 120
 Actuated Cycle Length: 120
 Offset: 67 (56%), Referenced to phase 2:SBTL and 6:NBTL, Start of Green
 Natural Cycle: 90
 Control Type: Actuated-Coordinated
 Maximum v/c Ratio: 0.59
 Intersection Signal Delay: 19.5
 Intersection Capacity Utilization 76.9%
 Analysis Period (min) 15
 m Volume for 95th percentile queue is metered by upstream signal.

Splits and Phases: 10: Robie & University

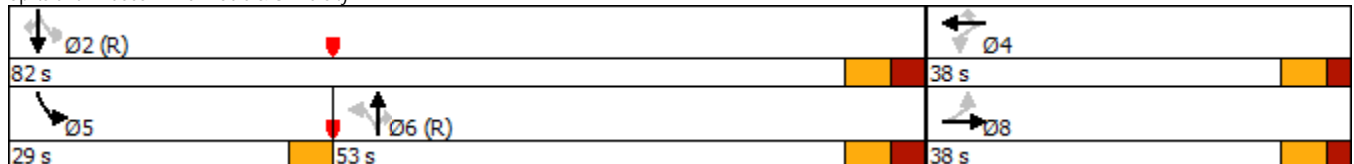

| Lane Group | EBL | EBT | WBL | WBT | NBL | NBT | NBR | SBL | SBT | SBR |
|------------------------|-------|-------|-------|-------|-------|-------|-------|-------|-------|-------|
| Lane Configurations | | | | | | | | | | |
| Traffic Volume (vph) | 50 | 290 | 10 | 135 | 25 | 221 | 30 | 175 | 275 | 40 |
| Future Volume (vph) | 50 | 290 | 10 | 135 | 25 | 221 | 30 | 175 | 275 | 40 |
| Lane Group Flow (vph) | 0 | 422 | 0 | 285 | 29 | 252 | 34 | 200 | 314 | 46 |
| Turn Type | Perm | NA | Perm | NA | Perm | NA | Perm | pm+pt | NA | Perm |
| Protected Phases | | 4 | | 4 | | 2 | | 1 | 6 | |
| Permitted Phases | 4 | | 4 | | 2 | | 2 | 6 | | 6 |
| Detector Phase | 4 | 4 | 4 | 4 | 2 | 2 | 2 | 1 | 6 | 6 |
| Switch Phase | | | | | | | | | | |
| Minimum Initial (s) | 10.0 | 10.0 | 10.0 | 10.0 | 10.0 | 10.0 | 10.0 | 8.0 | 10.0 | 10.0 |
| Minimum Split (s) | 47.8 | 47.8 | 47.8 | 47.8 | 24.7 | 24.7 | 24.7 | 13.0 | 24.7 | 24.7 |
| Total Split (s) | 67.0 | 67.0 | 67.0 | 67.0 | 30.0 | 30.0 | 30.0 | 23.0 | 53.0 | 53.0 |
| Total Split (%) | 55.8% | 55.8% | 55.8% | 55.8% | 25.0% | 25.0% | 25.0% | 19.2% | 44.2% | 44.2% |
| Yellow Time (s) | 4.1 | 4.1 | 4.1 | 4.1 | 4.1 | 4.1 | 4.1 | 4.0 | 4.1 | 4.1 |
| All-Red Time (s) | 2.7 | 2.7 | 2.7 | 2.7 | 1.6 | 1.6 | 1.6 | 0.0 | 1.6 | 1.6 |
| Lost Time Adjust (s) | | 0.0 | | 0.0 | 0.0 | 0.0 | 0.0 | 0.0 | 0.0 | 0.0 |
| Total Lost Time (s) | | 6.8 | | 6.8 | 5.7 | 5.7 | 5.7 | 4.0 | 5.7 | 5.7 |
| Lead/Lag | | | | | Lag | Lag | Lag | Lead | | |
| Lead-Lag Optimize? | | | | | | | | | | |
| Recall Mode | Ped | Ped | Ped | Ped | C-Min | C-Min | C-Min | None | C-Min | C-Min |
| Act Effct Green (s) | | 45.6 | | 45.6 | 44.0 | 44.0 | 44.0 | 63.6 | 61.9 | 61.9 |
| Actuated g/C Ratio | | 0.38 | | 0.38 | 0.37 | 0.37 | 0.37 | 0.53 | 0.52 | 0.52 |
| v/c Ratio | | 0.77 | | 0.45 | 0.10 | 0.41 | 0.09 | 0.43 | 0.40 | 0.09 |
| Control Delay | | 41.8 | | 24.9 | 32.1 | 34.2 | 1.3 | 23.1 | 25.5 | 12.3 |
| Queue Delay | | 0.0 | | 0.0 | 0.0 | 0.0 | 0.0 | 0.0 | 0.0 | 0.0 |
| Total Delay | | 41.8 | | 24.9 | 32.1 | 34.2 | 1.3 | 23.1 | 25.5 | 12.3 |
| LOS | | D | | C | C | C | A | C | C | B |
| Approach Delay | | 41.8 | | 24.9 | | 30.4 | | | 23.6 | |
| Approach LOS | | D | | C | | C | | | C | |
| Queue Length 50th (m) | | 90.9 | | 44.6 | 4.1 | 40.3 | 0.0 | 20.1 | 42.8 | 1.1 |
| Queue Length 95th (m) | | 106.4 | | 55.9 | 14.2 | 83.8 | 1.3 | 49.1 | 80.0 | m10.1 |
| Internal Link Dist (m) | | 115.5 | | 183.6 | | 422.3 | | | 167.5 | |
| Turn Bay Length (m) | | | | | 40.0 | | | 60.0 | | |
| Base Capacity (vph) | | 723 | | 818 | 292 | 608 | 372 | 503 | 782 | 515 |
| Starvation Cap Reductn | | 0 | | 0 | 0 | 0 | 0 | 0 | 0 | 0 |
| Spillback Cap Reductn | | 0 | | 0 | 0 | 0 | 0 | 0 | 0 | 0 |
| Storage Cap Reductn | | 0 | | 0 | 0 | 0 | 0 | 0 | 0 | 0 |
| Reduced v/c Ratio | | 0.58 | | 0.35 | 0.10 | 0.41 | 0.09 | 0.40 | 0.40 | 0.09 |

Intersection Summary

Cycle Length: 120
 Actuated Cycle Length: 120
 Offset: 28 (23%), Referenced to phase 2:NBTL and 6:SBTL, Start of Green
 Natural Cycle: 90
 Control Type: Actuated-Coordinated
 Maximum v/c Ratio: 0.77
 Intersection Signal Delay: 30.0
 Intersection Capacity Utilization 80.1%
 Analysis Period (min) 15
 m Volume for 95th percentile queue is metered by upstream signal.

Intersection LOS: C
 ICU Level of Service D

Splits and Phases: 11: Robie & South

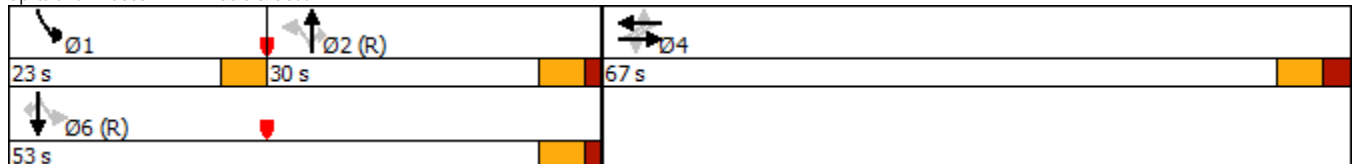

| Lane Group | EBL | EBT | WBL | WBT | WBR | NBL | NBT | SBL | SBT | SBR |
|------------------------|-------|-------|-------|-------|-------|-------|-------|-------|-------|-------|
| Lane Configurations | | | | | | | | | | |
| Traffic Volume (vph) | 20 | 260 | 65 | 185 | 170 | 10 | 40 | 210 | 105 | 20 |
| Future Volume (vph) | 20 | 260 | 65 | 185 | 170 | 10 | 40 | 210 | 105 | 20 |
| Lane Group Flow (vph) | 0 | 371 | 0 | 285 | 194 | 11 | 97 | 240 | 120 | 23 |
| Turn Type | Perm | NA | Perm | NA | Perm | Perm | NA | Perm | NA | Perm |
| Protected Phases | | 8 | | 4 | | | 6 | | 2 | |
| Permitted Phases | 8 | | 4 | | 4 | 6 | | 2 | | 2 |
| Detector Phase | 8 | 8 | 4 | 4 | 4 | 6 | 6 | 2 | 2 | 2 |
| Switch Phase | | | | | | | | | | |
| Minimum Initial (s) | 10.0 | 10.0 | 10.0 | 10.0 | 10.0 | 10.0 | 10.0 | 10.0 | 10.0 | 10.0 |
| Minimum Split (s) | 31.7 | 31.7 | 31.7 | 31.7 | 31.7 | 23.1 | 23.1 | 23.1 | 23.1 | 23.1 |
| Total Split (s) | 42.0 | 42.0 | 42.0 | 42.0 | 42.0 | 48.0 | 48.0 | 48.0 | 48.0 | 48.0 |
| Total Split (%) | 46.7% | 46.7% | 46.7% | 46.7% | 46.7% | 53.3% | 53.3% | 53.3% | 53.3% | 53.3% |
| Yellow Time (s) | 4.1 | 4.1 | 4.1 | 4.1 | 4.1 | 4.1 | 4.1 | 4.1 | 4.1 | 4.1 |
| All-Red Time (s) | 2.6 | 2.6 | 2.6 | 2.6 | 2.6 | 2.0 | 2.0 | 2.0 | 2.0 | 2.0 |
| Lost Time Adjust (s) | | 0.0 | | 0.0 | 0.0 | 0.0 | 0.0 | 0.0 | 0.0 | 0.0 |
| Total Lost Time (s) | | 6.7 | | 6.7 | 6.7 | 6.1 | 6.1 | 6.1 | 6.1 | 6.1 |
| Lead/Lag | | | | | | | | | | |
| Lead-Lag Optimize? | | | | | | | | | | |
| Recall Mode | Ped | Ped | Ped | Ped | Ped | C-Min | C-Min | C-Min | C-Min | C-Min |
| Act Effct Green (s) | | 27.8 | | 27.8 | 27.8 | 49.4 | 49.4 | 49.4 | 49.4 | 49.4 |
| Actuated g/C Ratio | | 0.31 | | 0.31 | 0.31 | 0.55 | 0.55 | 0.55 | 0.55 | 0.55 |
| v/c Ratio | | 0.70 | | 0.79 | 0.35 | 0.02 | 0.13 | 0.43 | 0.14 | 0.03 |
| Control Delay | | 33.8 | | 44.2 | 4.9 | 11.3 | 6.6 | 16.2 | 11.5 | 1.7 |
| Queue Delay | | 0.0 | | 0.0 | 0.0 | 0.0 | 0.0 | 0.0 | 0.0 | 0.0 |
| Total Delay | | 33.8 | | 44.2 | 4.9 | 11.3 | 6.6 | 16.2 | 11.5 | 1.7 |
| LOS | | C | | D | A | B | A | B | B | A |
| Approach Delay | | 33.8 | | 28.3 | | | 7.1 | | 13.9 | |
| Approach LOS | | C | | C | | | A | | B | |
| Queue Length 50th (m) | | 57.4 | | 46.9 | 0.0 | 0.8 | 3.2 | 21.2 | 8.7 | 0.0 |
| Queue Length 95th (m) | | 75.2 | | 67.0 | 12.6 | 3.7 | 12.4 | 49.1 | 21.4 | 1.9 |
| Internal Link Dist (m) | | 113.9 | | 142.4 | | | 118.8 | | 422.3 | |
| Turn Bay Length (m) | | | | | 50.0 | 60.0 | | 60.0 | | |
| Base Capacity (vph) | | 674 | | 460 | 654 | 637 | 760 | 554 | 851 | 684 |
| Starvation Cap Reductn | | 0 | | 0 | 0 | 0 | 0 | 0 | 0 | 0 |
| Spillback Cap Reductn | | 0 | | 0 | 0 | 0 | 0 | 0 | 0 | 0 |
| Storage Cap Reductn | | 0 | | 0 | 0 | 0 | 0 | 0 | 0 | 0 |
| Reduced v/c Ratio | | 0.55 | | 0.62 | 0.30 | 0.02 | 0.13 | 0.43 | 0.14 | 0.03 |

Intersection Summary

Cycle Length: 90
 Actuated Cycle Length: 90
 Offset: 0 (0%), Referenced to phase 2:SBTL and 6:NBTL, Start of Green
 Natural Cycle: 55
 Control Type: Actuated-Coordinated
 Maximum v/c Ratio: 0.79
 Intersection Signal Delay: 24.0
 Intersection Capacity Utilization 72.1%
 Analysis Period (min) 15

Intersection LOS: C
 ICU Level of Service C

Splits and Phases: 12: Robie & Inglis

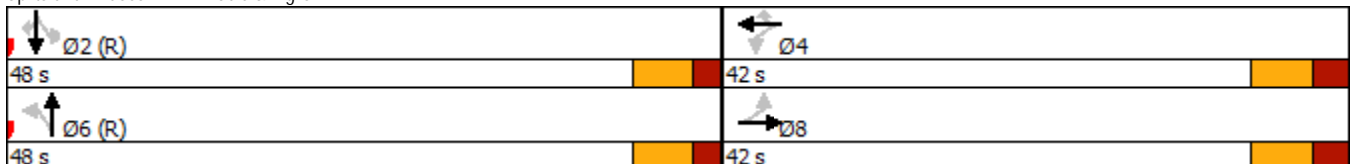









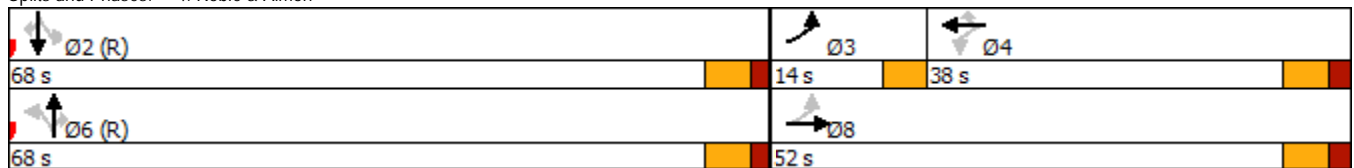



| Lane Group | EBL | EBT | WBL | WBT | WBR | NBL | NBT | NBR | SBL | SBT | SBR |
|------------------------|-------|-------|-------|--------|-------|-------|--------|-------|-------|-------|-------|
| Lane Configurations | | | | | | | | | | | |
| Traffic Volume (vph) | 190 | 195 | 15 | 470 | 125 | 30 | 747 | 10 | 20 | 369 | 130 |
| Future Volume (vph) | 190 | 195 | 15 | 470 | 125 | 30 | 747 | 10 | 20 | 369 | 130 |
| Lane Group Flow (vph) | 217 | 291 | 0 | 553 | 143 | 34 | 853 | 11 | 23 | 421 | 148 |
| Turn Type | pm+pt | NA | Perm | NA | Perm | Perm | NA | Perm | Perm | NA | Perm |
| Protected Phases | 3 | 8 | | 4 | | | 6 | | | 2 | |
| Permitted Phases | 8 | | 4 | | 4 | 6 | | 6 | 2 | | 2 |
| Detector Phase | 3 | 8 | 4 | 4 | 4 | 6 | 6 | 6 | 2 | 2 | 2 |
| Switch Phase | | | | | | | | | | | |
| Minimum Initial (s) | 7.0 | 10.0 | 10.0 | 10.0 | 10.0 | 10.0 | 10.0 | 10.0 | 10.0 | 10.0 | 10.0 |
| Minimum Split (s) | 11.0 | 50.0 | 37.0 | 37.0 | 37.0 | 40.0 | 40.0 | 40.0 | 40.0 | 40.0 | 40.0 |
| Total Split (s) | 14.0 | 52.0 | 38.0 | 38.0 | 38.0 | 68.0 | 68.0 | 68.0 | 68.0 | 68.0 | 68.0 |
| Total Split (%) | 11.7% | 43.3% | 31.7% | 31.7% | 31.7% | 56.7% | 56.7% | 56.7% | 56.7% | 56.7% | 56.7% |
| Yellow Time (s) | 4.0 | 4.1 | 4.1 | 4.1 | 4.1 | 4.1 | 4.1 | 4.1 | 4.1 | 4.1 | 4.1 |
| All-Red Time (s) | 0.0 | 2.1 | 2.1 | 2.1 | 2.1 | 1.7 | 1.7 | 1.7 | 1.7 | 1.7 | 1.7 |
| Lost Time Adjust (s) | 0.0 | 0.0 | | 0.0 | 0.0 | 0.0 | 0.0 | 0.0 | 0.0 | 0.0 | 0.0 |
| Total Lost Time (s) | 4.0 | 6.2 | | 6.2 | 6.2 | 5.8 | 5.8 | 5.8 | 5.8 | 5.8 | 5.8 |
| Lead/Lag | Lead | | Lag | Lag | Lag | | | | | | |
| Lead-Lag Optimize? | | | | | | | | | | | |
| Recall Mode | None | None | None | None | None | C-Min | C-Min | C-Min | C-Min | C-Min | C-Min |
| Act Effct Green (s) | 49.4 | 47.2 | | 31.8 | 31.8 | 60.8 | 60.8 | 60.8 | 60.8 | 60.8 | 60.8 |
| Actuated g/C Ratio | 0.41 | 0.39 | | 0.26 | 0.26 | 0.51 | 0.51 | 0.51 | 0.51 | 0.51 | 0.51 |
| v/c Ratio | 0.95 | 0.42 | | 0.97 | 0.33 | 0.09 | 0.96 | 0.01 | 0.33 | 0.46 | 0.37 |
| Control Delay | 76.9 | 27.8 | | 75.5 | 18.7 | 15.6 | 50.8 | 0.0 | 17.4 | 7.0 | 2.0 |
| Queue Delay | 0.0 | 0.0 | | 0.0 | 0.0 | 0.0 | 0.0 | 0.0 | 0.0 | 0.0 | 0.0 |
| Total Delay | 76.9 | 27.8 | | 75.5 | 18.7 | 15.6 | 50.8 | 0.0 | 17.4 | 7.0 | 2.0 |
| LOS | E | C | | E | B | B | D | A | B | A | A |
| Approach Delay | | 48.8 | | 63.8 | | | 48.8 | | | 6.2 | |
| Approach LOS | | D | | E | | | D | | | A | |
| Queue Length 50th (m) | -38.8 | 47.6 | | 129.3 | 11.5 | 3.9 | 181.6 | 0.0 | 0.7 | 12.7 | 0.0 |
| Queue Length 95th (m) | #87.7 | 72.1 | | #198.1 | 29.1 | 9.6 | #269.1 | 0.0 | m1.9 | m26.0 | m0.0 |
| Internal Link Dist (m) | | 253.6 | | 180.4 | | | 402.8 | | | 360.9 | |
| Turn Bay Length (m) | 80.0 | | | | 50.0 | 40.0 | | | 50.0 | | |
| Base Capacity (vph) | 229 | 690 | | 569 | 427 | 370 | 909 | 773 | 72 | 945 | 405 |
| Starvation Cap Reductn | 0 | 0 | | 0 | 0 | 0 | 0 | 0 | 0 | 0 | 0 |
| Spillback Cap Reductn | 0 | 0 | | 0 | 0 | 0 | 0 | 0 | 0 | 0 | 0 |
| Storage Cap Reductn | 0 | 0 | | 0 | 0 | 0 | 0 | 0 | 0 | 0 | 0 |
| Reduced v/c Ratio | 0.95 | 0.42 | | 0.97 | 0.33 | 0.09 | 0.94 | 0.01 | 0.32 | 0.45 | 0.37 |

Intersection Summary

Cycle Length: 120
 Actuated Cycle Length: 120
 Offset: 85 (71%), Referenced to phase 2:SBTL and 6:NBTL, Start of Green
 Natural Cycle: 100
 Control Type: Actuated-Coordinated
 Maximum v/c Ratio: 0.97
 Intersection Signal Delay: 43.3
 Intersection Capacity Utilization 116.3%
 Analysis Period (min) 15
 ~ Volume exceeds capacity, queue is theoretically infinite.
 Queue shown is maximum after two cycles.
 # 95th percentile volume exceeds capacity, queue may be longer.
 Queue shown is maximum after two cycles.
 m Volume for 95th percentile queue is metered by upstream signal.

Splits and Phases: 4: Robie & Almon



| |  |  |  |  |  |  |
|------------------------|---|---|---|---|---|---|
| Lane Group | EBT | WBT | NBT | NBR | SBT | SBR |
| Lane Configurations |  |  |  |  |  |  |
| Traffic Volume (vph) | 345 | 445 | 657 | 375 | 514 | 30 |
| Future Volume (vph) | 345 | 445 | 657 | 375 | 514 | 30 |
| Lane Group Flow (vph) | 423 | 531 | 750 | 428 | 587 | 34 |
| Turn Type | NA | NA | NA | Perm | NA | Perm |
| Protected Phases | 8 | 4 | 6 | | 2 | |
| Permitted Phases | | | | 6 | | 2 |
| Detector Phase | 8 | 4 | 6 | 6 | 2 | 2 |
| Switch Phase | | | | | | |
| Minimum Initial (s) | 10.0 | 10.0 | 10.0 | 10.0 | 10.0 | 10.0 |
| Minimum Split (s) | 23.7 | 23.7 | 54.0 | 54.0 | 54.0 | 54.0 |
| Total Split (s) | 36.0 | 36.0 | 54.0 | 54.0 | 54.0 | 54.0 |
| Total Split (%) | 40.0% | 40.0% | 60.0% | 60.0% | 60.0% | 60.0% |
| Yellow Time (s) | 4.1 | 4.1 | 4.1 | 4.1 | 4.1 | 4.1 |
| All-Red Time (s) | 1.6 | 1.6 | 1.5 | 1.5 | 1.5 | 1.5 |
| Lost Time Adjust (s) | 0.0 | 0.0 | 0.0 | 0.0 | 0.0 | 0.0 |
| Total Lost Time (s) | 5.7 | 5.7 | 5.6 | 5.6 | 5.6 | 5.6 |
| Lead/Lag | | | | | | |
| Lead-Lag Optimize? | | | | | | |
| Recall Mode | Ped | Ped | C-Min | C-Min | C-Min | C-Min |
| Act Effct Green (s) | 28.5 | 28.5 | 50.2 | 50.2 | 50.2 | 50.2 |
| Actuated g/C Ratio | 0.32 | 0.32 | 0.56 | 0.56 | 0.56 | 0.56 |
| v/c Ratio | 0.75 | 0.91 | 0.77 | 0.98 | 0.59 | 0.04 |
| Control Delay | 36.5 | 50.1 | 23.0 | 54.9 | 16.7 | 3.6 |
| Queue Delay | 0.0 | 0.0 | 0.0 | 0.0 | 0.0 | 0.0 |
| Total Delay | 36.5 | 50.1 | 23.0 | 54.9 | 16.7 | 3.6 |
| LOS | D | D | C | D | B | A |
| Approach Delay | 36.5 | 50.1 | 34.6 | | 16.0 | |
| Approach LOS | D | D | C | | B | |
| Queue Length 50th (m) | 62.4 | 84.0 | 99.1 | ~54.7 | 65.8 | 0.0 |
| Queue Length 95th (m) | 95.4 | #139.1 | 150.8 | #121.9 | 98.3 | 4.1 |
| Internal Link Dist (m) | 320.4 | 233.6 | 68.2 | | 402.8 | |
| Turn Bay Length (m) | | | | 50.0 | | |
| Base Capacity (vph) | 597 | 623 | 971 | 438 | 997 | 836 |
| Starvation Cap Reductn | 0 | 0 | 0 | 0 | 0 | 0 |
| Spillback Cap Reductn | 0 | 0 | 0 | 0 | 0 | 0 |
| Storage Cap Reductn | 0 | 0 | 0 | 0 | 0 | 0 |
| Reduced v/c Ratio | 0.71 | 0.85 | 0.77 | 0.98 | 0.59 | 0.04 |

Intersection Summary

Cycle Length: 90
 Actuated Cycle Length: 90
 Offset: 0 (0%), Referenced to phase 2:SBT and 6:NBT, Start of Green
 Natural Cycle: 90
 Control Type: Actuated-Coordinated
 Maximum v/c Ratio: 0.98
 Intersection Signal Delay: 33.7
 Intersection Capacity Utilization 81.6%
 Analysis Period (min) 15
 ~ Volume exceeds capacity, queue is theoretically infinite.
 Queue shown is maximum after two cycles.
 # 95th percentile volume exceeds capacity, queue may be longer.
 Queue shown is maximum after two cycles.

Splits and Phases: 5: Robie & North

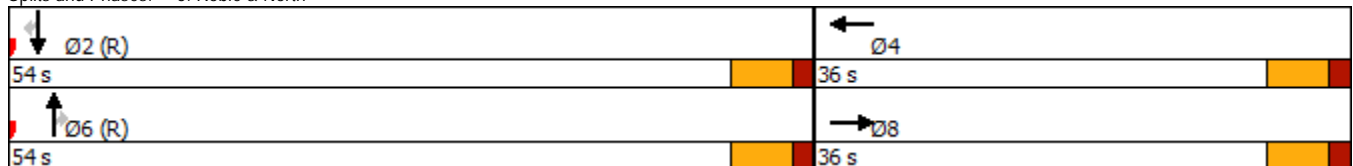

| Lane Group | EBL | EBT | WBL | WBT | WBR | NBL | NBT | NBR | SBL | SBT | SBR |
|------------------------|-------|-------|-------|--------|-------|-------|--------|-------|-------|-------|-------|
| Lane Configurations | | | | | | | | | | | |
| Traffic Volume (vph) | 20 | 300 | 65 | 475 | 75 | 50 | 747 | 60 | 55 | 534 | 50 |
| Future Volume (vph) | 20 | 300 | 65 | 475 | 75 | 50 | 747 | 60 | 55 | 534 | 50 |
| Lane Group Flow (vph) | 23 | 349 | 74 | 542 | 86 | 57 | 853 | 68 | 63 | 609 | 57 |
| Turn Type | Perm | NA | Perm | NA | Perm | pm+pt | NA | Perm | Perm | NA | Perm |
| Protected Phases | | 8 | | 4 | | 1 | 6 | | | 2 | |
| Permitted Phases | 8 | | 4 | | 4 | 6 | | 6 | 2 | | 2 |
| Detector Phase | 8 | 8 | 4 | 4 | 4 | 1 | 6 | 6 | 2 | 2 | 2 |
| Switch Phase | | | | | | | | | | | |
| Minimum Initial (s) | 10.0 | 10.0 | 10.0 | 10.0 | 10.0 | 8.0 | 8.0 | 8.0 | 10.0 | 10.0 | 10.0 |
| Minimum Split (s) | 39.1 | 39.1 | 39.1 | 39.1 | 39.1 | 13.0 | 24.0 | 24.0 | 37.9 | 37.9 | 37.9 |
| Total Split (s) | 49.0 | 49.0 | 49.0 | 49.0 | 49.0 | 13.0 | 71.0 | 71.0 | 58.0 | 58.0 | 58.0 |
| Total Split (%) | 40.8% | 40.8% | 40.8% | 40.8% | 40.8% | 10.8% | 59.2% | 59.2% | 48.3% | 48.3% | 48.3% |
| Yellow Time (s) | 4.1 | 4.1 | 4.1 | 4.1 | 4.1 | 3.0 | 4.0 | 4.0 | 4.1 | 4.1 | 4.1 |
| All-Red Time (s) | 3.0 | 3.0 | 3.0 | 3.0 | 3.0 | 0.0 | 2.0 | 2.0 | 2.0 | 2.0 | 2.0 |
| Lost Time Adjust (s) | 0.0 | 0.0 | 0.0 | 0.0 | 0.0 | 0.0 | 0.0 | 0.0 | 0.0 | 0.0 | 0.0 |
| Total Lost Time (s) | 7.1 | 7.1 | 7.1 | 7.1 | 7.1 | 3.0 | 6.0 | 6.0 | 6.1 | 6.1 | 6.1 |
| Lead/Lag | | | | | | Lead | | | Lag | Lag | Lag |
| Lead-Lag Optimize? | | | | | | | | | | | |
| Recall Mode | Ped | Ped | Ped | Ped | Ped | None | C-Min | C-Min | C-Min | C-Min | C-Min |
| Act Effct Green (s) | 39.3 | 39.3 | 39.3 | 39.3 | 39.3 | 70.6 | 67.6 | 67.6 | 58.4 | 58.4 | 58.4 |
| Actuated g/C Ratio | 0.33 | 0.33 | 0.33 | 0.33 | 0.33 | 0.59 | 0.56 | 0.56 | 0.49 | 0.49 | 0.49 |
| v/c Ratio | 0.35 | 0.71 | 0.34 | 0.91 | 0.18 | 0.18 | 0.83 | 0.09 | 0.45 | 0.69 | 0.07 |
| Control Delay | 47.0 | 43.5 | 34.7 | 58.6 | 12.7 | 12.8 | 31.1 | 4.7 | 37.0 | 30.5 | 4.1 |
| Queue Delay | 0.0 | 0.0 | 0.0 | 0.0 | 0.0 | 0.0 | 0.0 | 0.0 | 0.0 | 0.0 | 0.0 |
| Total Delay | 47.0 | 43.5 | 34.7 | 58.6 | 12.7 | 12.8 | 31.1 | 4.7 | 37.0 | 30.5 | 4.1 |
| LOS | D | D | C | E | B | B | C | A | D | C | A |
| Approach Delay | | 43.7 | | 50.4 | | | 28.2 | | | 29.0 | |
| Approach LOS | | D | | D | | | C | | | C | |
| Queue Length 50th (m) | 3.9 | 68.3 | 12.6 | 116.3 | 4.8 | 5.8 | 168.3 | 1.2 | 10.4 | 117.3 | 0.0 |
| Queue Length 95th (m) | 12.8 | 102.2 | 26.3 | #175.7 | 16.1 | 11.8 | #239.8 | 7.8 | 27.5 | 164.0 | 6.4 |
| Internal Link Dist (m) | | 72.7 | | 213.1 | | | 210.2 | | | 354.7 | |
| Turn Bay Length (m) | 50.0 | | | | 50.0 | 40.0 | | | 40.0 | | |
| Base Capacity (vph) | 69 | 528 | 230 | 638 | 494 | 343 | 1029 | 743 | 139 | 888 | 796 |
| Starvation Cap Reductn | 0 | 0 | 0 | 0 | 0 | 0 | 0 | 0 | 0 | 0 | 0 |
| Spillback Cap Reductn | 0 | 0 | 0 | 0 | 0 | 0 | 0 | 0 | 0 | 0 | 0 |
| Storage Cap Reductn | 0 | 0 | 0 | 0 | 0 | 0 | 0 | 0 | 0 | 0 | 0 |
| Reduced v/c Ratio | 0.33 | 0.66 | 0.32 | 0.85 | 0.17 | 0.17 | 0.83 | 0.09 | 0.45 | 0.69 | 0.07 |

Intersection Summary

Cycle Length: 120
 Actuated Cycle Length: 120
 Offset: 0 (0%), Referenced to phase 2:SBTL and 6:NBT, Start of Green
 Natural Cycle: 90
 Control Type: Actuated-Coordinated
 Maximum v/c Ratio: 0.91
 Intersection Signal Delay: 36.1
 Intersection Capacity Utilization 99.9%
 Analysis Period (min) 15
 # 95th percentile volume exceeds capacity, queue may be longer.
 Queue shown is maximum after two cycles.

Intersection LOS: D
 ICU Level of Service F

Splits and Phases: 6: Robie & Cunard

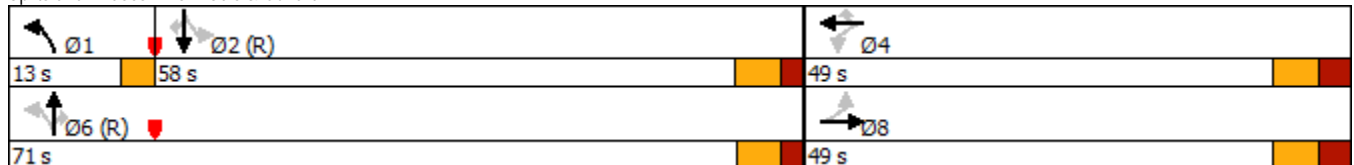

| Lane Group | EBT | EBR | EBR2 | WBT | NBL | NBT | NBR | SBL2 | SBL | SBT | SBR | NWL |
|------------------------|-------|-------|-------|--------|--------|--------|-------|-------|--------|-------|-------|--------|
| Lane Configurations | | | | | | | | | | | | |
| Traffic Volume (vph) | 215 | 295 | 140 | 535 | 245 | 756 | 30 | 70 | 140 | 542 | 60 | 625 |
| Future Volume (vph) | 215 | 295 | 140 | 535 | 245 | 756 | 30 | 70 | 140 | 542 | 60 | 625 |
| Lane Group Flow (vph) | 245 | 337 | 160 | 679 | 280 | 863 | 68 | 0 | 240 | 619 | 68 | 941 |
| Turn Type | NA | pt+ov | Perm | NA | pm+pt | NA | Perm | pm+pt | pm+pt | NA | Perm | Prot |
| Protected Phases | 7 | 7 8 | | 7 | 1 | 6 | | 5 | 5 | 2 | | 8 |
| Permitted Phases | | | 7 | | 6 | | 6 | 2 | 2 | | 2 | |
| Minimum Split (s) | 37.0 | | 37.0 | 37.0 | 14.0 | 36.0 | 36.0 | 14.0 | 14.0 | 49.0 | 49.0 | 36.0 |
| Total Split (s) | 37.0 | | 37.0 | 37.0 | 19.0 | 44.0 | 44.0 | 19.0 | 19.0 | 44.0 | 44.0 | 50.0 |
| Total Split (%) | 24.7% | | 24.7% | 24.7% | 12.7% | 29.3% | 29.3% | 12.7% | 12.7% | 29.3% | 29.3% | 33.3% |
| Yellow Time (s) | 4.0 | | 4.0 | 4.0 | 4.0 | 4.0 | 4.0 | 4.0 | 4.0 | 4.0 | 4.0 | 4.0 |
| All-Red Time (s) | 4.0 | | 4.0 | 4.0 | 0.0 | 3.0 | 3.0 | 0.0 | 0.0 | 3.0 | 3.0 | 4.0 |
| Lost Time Adjust (s) | -1.0 | | -1.0 | -1.0 | -1.0 | -1.0 | 0.0 | | 0.0 | -1.0 | 0.0 | -1.0 |
| Total Lost Time (s) | 7.0 | | 7.0 | 7.0 | 3.0 | 6.0 | 7.0 | | 4.0 | 6.0 | 7.0 | 7.0 |
| Lead/Lag | Lead | | Lead | Lead | Lead | Lag | Lag | Lead | Lead | Lag | Lag | Lag |
| Lead-Lag Optimize? | | | | | | | | | | | | |
| Act Effct Green (s) | 30.0 | 80.0 | 30.0 | 30.0 | 57.0 | 38.0 | 37.0 | | 55.0 | 38.0 | 37.0 | 43.0 |
| Actuated g/C Ratio | 0.20 | 0.53 | 0.20 | 0.20 | 0.38 | 0.25 | 0.25 | | 0.37 | 0.25 | 0.25 | 0.29 |
| v/c Ratio | 0.68 | 0.41 | 0.43 | 1.00 | 0.97 | 1.02 | 0.22 | | 1.08 | 0.79 | 0.17 | 1.02 |
| Control Delay | 66.1 | 22.9 | 13.7 | 93.4 | 80.9 | 89.6 | 47.5 | | 120.3 | 60.5 | 0.9 | 87.8 |
| Queue Delay | 0.0 | 0.0 | 0.0 | 0.0 | 0.0 | 0.0 | 0.0 | | 0.0 | 0.0 | 0.0 | 0.0 |
| Total Delay | 66.1 | 22.9 | 13.7 | 93.4 | 80.9 | 89.6 | 47.5 | | 120.3 | 60.5 | 0.9 | 87.8 |
| LOS | E | C | B | F | F | F | D | | F | E | A | F |
| Approach Delay | 35.2 | | | 93.4 | | 85.2 | | | | 71.6 | | 87.8 |
| Approach LOS | D | | | F | | F | | | | E | | F |
| Queue Length 50th (m) | 68.3 | 58.3 | 3.7 | -106.8 | 59.2 | -142.3 | 16.3 | | -62.8 | 91.1 | 0.0 | -152.9 |
| Queue Length 95th (m) | 98.6 | 82.6 | 24.6 | #149.2 | #107.9 | #183.5 | 30.3 | | #118.5 | 114.0 | 0.0 | #193.6 |
| Internal Link Dist (m) | 274.0 | | | 207.4 | | 413.3 | | | | 168.1 | | 150.4 |
| Turn Bay Length (m) | | 70.0 | 70.0 | | 180.0 | | | | 80.0 | | | |
| Base Capacity (vph) | 361 | 819 | 372 | 678 | 289 | 849 | 305 | | 223 | 786 | 408 | 919 |
| Starvation Cap Reductn | 0 | 0 | 0 | 0 | 0 | 0 | 0 | | 0 | 0 | 0 | 0 |
| Spillback Cap Reductn | 0 | 0 | 0 | 0 | 0 | 0 | 0 | | 0 | 0 | 0 | 0 |
| Storage Cap Reductn | 0 | 0 | 0 | 0 | 0 | 0 | 0 | | 0 | 0 | 0 | 0 |
| Reduced v/c Ratio | 0.68 | 0.41 | 0.43 | 1.00 | 0.97 | 1.02 | 0.22 | | 1.08 | 0.79 | 0.17 | 1.02 |

Intersection Summary

Cycle Length: 150
 Actuated Cycle Length: 150
 Offset: 0 (0%), Referenced to phase 2:SBTL and 6:NBTL, Start of Green
 Natural Cycle: 140
 Control Type: Pretimed
 Maximum v/c Ratio: 1.08
 Intersection Signal Delay: 75.9
 Intersection Capacity Utilization 119.4%
 Analysis Period (min) 15
 - Volume exceeds capacity, queue is theoretically infinite.
 Queue shown is maximum after two cycles.
 # 95th percentile volume exceeds capacity, queue may be longer.
 Queue shown is maximum after two cycles.

Splits and Phases: 7: Robie & Bell & Quinpool/Cogswell

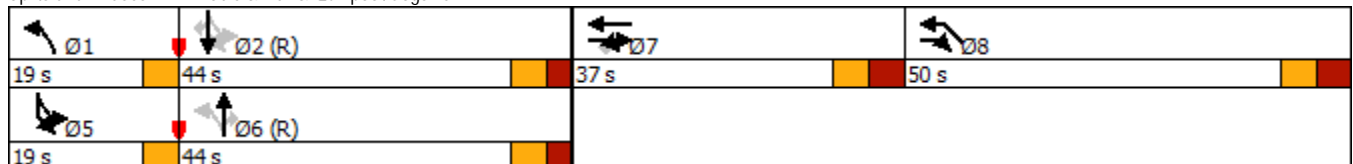

Halifax Transit Priority Corridors
8: Robie & Jubilee/Veterans Memorial

| Lane Group | EBL | EBT | WBL | WBT | WBR | NBL | NBT | NBR | SBL | SBT | SBR |
|------------------------|-------|-------|-------|-------|-------|-------|-------|-------|-------|-------|-------|
| Lane Configurations | | | | | | | | | | | |
| Traffic Volume (vph) | 60 | 135 | 15 | 340 | 120 | 160 | 721 | 45 | 105 | 607 | 30 |
| Future Volume (vph) | 60 | 135 | 15 | 340 | 120 | 160 | 721 | 45 | 105 | 607 | 30 |
| Lane Group Flow (vph) | 0 | 268 | 0 | 405 | 137 | 183 | 823 | 51 | 120 | 693 | 34 |
| Turn Type | Perm | NA | Perm | NA | Perm | pm+pt | NA | Perm | pm+pt | NA | Perm |
| Protected Phases | | 8 | | 4 | | 1 | 6 | | 5 | 2 | |
| Permitted Phases | 8 | | 4 | | 4 | 6 | | 6 | 2 | | 2 |
| Detector Phase | 8 | 8 | 4 | 4 | 4 | 1 | 6 | 6 | 5 | 2 | 2 |
| Switch Phase | | | | | | | | | | | |
| Minimum Initial (s) | 10.0 | 10.0 | 10.0 | 10.0 | 10.0 | 7.0 | 10.0 | 10.0 | 7.0 | 10.0 | 10.0 |
| Minimum Split (s) | 31.6 | 31.6 | 31.6 | 31.6 | 31.6 | 11.0 | 22.8 | 22.8 | 11.0 | 22.8 | 22.8 |
| Total Split (s) | 43.0 | 43.0 | 43.0 | 43.0 | 43.0 | 14.0 | 66.0 | 66.0 | 11.0 | 63.0 | 63.0 |
| Total Split (%) | 35.8% | 35.8% | 35.8% | 35.8% | 35.8% | 11.7% | 55.0% | 55.0% | 9.2% | 52.5% | 52.5% |
| Yellow Time (s) | 4.1 | 4.1 | 4.1 | 4.1 | 4.1 | 4.0 | 4.1 | 4.1 | 4.0 | 4.1 | 4.1 |
| All-Red Time (s) | 2.4 | 2.4 | 2.4 | 2.4 | 2.4 | 0.0 | 1.7 | 1.7 | 0.0 | 1.7 | 1.7 |
| Lost Time Adjust (s) | | 0.0 | | 0.0 | 0.0 | 0.0 | 0.0 | 0.0 | 0.0 | 0.0 | 0.0 |
| Total Lost Time (s) | | 6.5 | | 6.5 | 6.5 | 4.0 | 5.8 | 5.8 | 4.0 | 5.8 | 5.8 |
| Lead/Lag | | | | | | Lead | Lag | Lag | Lead | Lag | Lag |
| Lead-Lag Optimize? | | | | | | | | | | | |
| Recall Mode | Ped | Ped | Ped | Ped | Ped | None | C-Min | C-Min | None | C-Min | C-Min |
| Act Effct Green (s) | | 50.9 | | 50.9 | 50.9 | 57.5 | 44.4 | 44.4 | 51.8 | 41.5 | 41.5 |
| Actuated g/C Ratio | | 0.42 | | 0.42 | 0.42 | 0.48 | 0.37 | 0.37 | 0.43 | 0.35 | 0.35 |
| v/c Ratio | | 0.53 | | 0.54 | 0.23 | 0.64 | 0.68 | 0.23 | 0.50 | 0.61 | 0.10 |
| Control Delay | | 30.1 | | 29.5 | 9.7 | 32.8 | 24.7 | 3.0 | 24.7 | 34.9 | 1.5 |
| Queue Delay | | 0.0 | | 0.0 | 0.0 | 0.0 | 0.0 | 0.0 | 0.0 | 0.0 | 0.0 |
| Total Delay | | 30.1 | | 29.5 | 9.7 | 32.8 | 24.7 | 3.0 | 24.7 | 34.9 | 1.5 |
| LOS | | C | | C | A | C | C | A | C | C | A |
| Approach Delay | | 30.1 | | 24.5 | | | 25.1 | | | 32.1 | |
| Approach LOS | | C | | C | | | C | | | C | |
| Queue Length 50th (m) | | 45.3 | | 71.0 | 6.5 | 13.7 | 83.8 | 0.0 | 14.8 | 71.7 | 0.0 |
| Queue Length 95th (m) | | 74.9 | | 105.0 | 20.1 | m42.3 | 51.7 | m1.0 | 24.6 | 84.5 | 1.5 |
| Internal Link Dist (m) | | 189.8 | | 183.6 | | | 355.1 | | | 413.3 | |
| Turn Bay Length (m) | | | | | 40.0 | 50.0 | | | 90.0 | | |
| Base Capacity (vph) | | 506 | | 757 | 597 | 288 | 1637 | 278 | 239 | 1571 | 463 |
| Starvation Cap Reductn | | 0 | | 0 | 0 | 0 | 0 | 0 | 0 | 0 | 0 |
| Spillback Cap Reductn | | 0 | | 0 | 0 | 0 | 0 | 0 | 0 | 0 | 0 |
| Storage Cap Reductn | | 0 | | 0 | 0 | 0 | 0 | 0 | 0 | 0 | 0 |
| Reduced v/c Ratio | | 0.53 | | 0.54 | 0.23 | 0.64 | 0.50 | 0.18 | 0.50 | 0.44 | 0.07 |

Intersection Summary

Cycle Length: 120
 Actuated Cycle Length: 120
 Offset: 76 (63%), Referenced to phase 2:SBTL and 6:NBTL, Start of Green
 Natural Cycle: 70
 Control Type: Actuated-Coordinated
 Maximum v/c Ratio: 0.68
 Intersection Signal Delay: 27.7
 Intersection Capacity Utilization 87.7%
 Analysis Period (min) 15
 m Volume for 95th percentile queue is metered by upstream signal.

Intersection LOS: C
 ICU Level of Service E

Splits and Phases: 8: Robie & Jubilee/Veterans Memorial

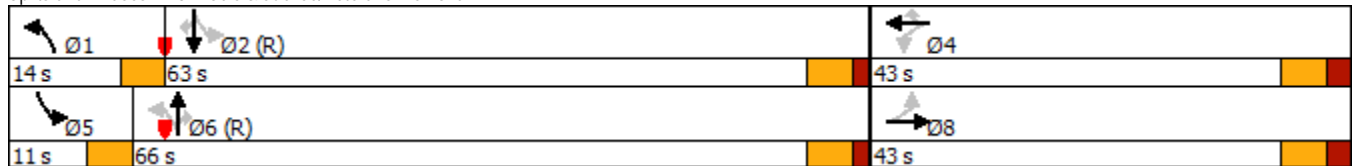

| Lane Group | EBL | EBT | WBL | WBT | NBL | NBT | NBR | SBL | SBT | SBR |
|------------------------|-------|-------|-------|-------|-------|-------|-------|-------|-------|-------|
| Lane Configurations | | | | | | | | | | |
| Traffic Volume (vph) | 55 | 135 | 40 | 315 | 160 | 717 | 30 | 120 | 375 | 35 |
| Future Volume (vph) | 55 | 135 | 40 | 315 | 160 | 717 | 30 | 120 | 375 | 35 |
| Lane Group Flow (vph) | 63 | 154 | 0 | 611 | 183 | 818 | 34 | 137 | 428 | 40 |
| Turn Type | Perm | NA | Perm | NA | pm+pt | NA | Perm | pm+pt | NA | Perm |
| Protected Phases | | 4 | | 4 | 5 | 2 | | 1 | 6 | |
| Permitted Phases | 4 | | 4 | | 2 | | 2 | 6 | | 6 |
| Detector Phase | 4 | 4 | 4 | 4 | 5 | 2 | 2 | 1 | 6 | 6 |
| Switch Phase | | | | | | | | | | |
| Minimum Initial (s) | 10.0 | 10.0 | 10.0 | 10.0 | 8.0 | 10.0 | 10.0 | 8.0 | 10.0 | 10.0 |
| Minimum Split (s) | 33.5 | 33.5 | 33.5 | 33.5 | 13.0 | 34.5 | 34.5 | 13.0 | 34.5 | 34.5 |
| Total Split (s) | 39.0 | 39.0 | 39.0 | 39.0 | 13.0 | 68.0 | 68.0 | 13.0 | 68.0 | 68.0 |
| Total Split (%) | 32.5% | 32.5% | 32.5% | 32.5% | 10.8% | 56.7% | 56.7% | 10.8% | 56.7% | 56.7% |
| Yellow Time (s) | 4.1 | 4.1 | 4.1 | 4.1 | 4.0 | 4.1 | 4.1 | 4.0 | 4.1 | 4.1 |
| All-Red Time (s) | 2.4 | 2.4 | 2.4 | 2.4 | 1.0 | 2.4 | 2.4 | 1.0 | 2.4 | 2.4 |
| Lost Time Adjust (s) | 0.0 | 0.0 | | 0.0 | 0.0 | 0.0 | 0.0 | 0.0 | 0.0 | 0.0 |
| Total Lost Time (s) | 6.5 | 6.5 | | 6.5 | 5.0 | 6.5 | 6.5 | 5.0 | 6.5 | 6.5 |
| Lead/Lag | | | | | Lead | Lag | Lag | Lead | Lag | Lag |
| Lead-Lag Optimize? | | | | | | | | | | |
| Recall Mode | None | None | None | None | None | C-Min | C-Min | None | C-Min | C-Min |
| Act Effct Green (s) | 35.0 | 35.0 | | 35.0 | 69.4 | 57.9 | 57.9 | 67.6 | 57.1 | 57.1 |
| Actuated g/C Ratio | 0.29 | 0.29 | | 0.29 | 0.58 | 0.48 | 0.48 | 0.56 | 0.48 | 0.48 |
| v/c Ratio | 0.47 | 0.29 | | 0.80 | 0.38 | 0.54 | 0.09 | 0.40 | 0.53 | 0.06 |
| Control Delay | 45.3 | 32.8 | | 42.5 | 14.2 | 24.7 | 0.4 | 38.9 | 57.2 | 17.3 |
| Queue Delay | 0.0 | 0.0 | | 0.0 | 0.0 | 0.0 | 0.0 | 0.0 | 0.0 | 0.0 |
| Total Delay | 45.3 | 32.8 | | 42.5 | 14.2 | 24.7 | 0.4 | 38.9 | 57.2 | 17.3 |
| LOS | D | C | | D | B | C | A | D | E | B |
| Approach Delay | | 36.5 | | 42.5 | | 22.1 | | | 50.4 | |
| Approach LOS | | D | | D | | C | | | D | |
| Queue Length 50th (m) | 12.1 | 27.8 | | 61.8 | 17.8 | 70.6 | 0.0 | 32.1 | 107.7 | 3.4 |
| Queue Length 95th (m) | 24.8 | 41.1 | | 76.5 | 33.6 | 99.1 | 0.1 | 41.6 | 100.2 | m7.5 |
| Internal Link Dist (m) | | 121.4 | | 242.2 | | 240.3 | | | 355.1 | |
| Turn Bay Length (m) | 30.0 | | | | 60.0 | | | | | |
| Base Capacity (vph) | 140 | 563 | | 795 | 479 | 1643 | 423 | 341 | 893 | 699 |
| Starvation Cap Reductn | 0 | 0 | | 0 | 0 | 0 | 0 | 0 | 0 | 0 |
| Spillback Cap Reductn | 0 | 0 | | 0 | 0 | 0 | 0 | 0 | 0 | 0 |
| Storage Cap Reductn | 0 | 0 | | 0 | 0 | 0 | 0 | 0 | 0 | 0 |
| Reduced v/c Ratio | 0.45 | 0.27 | | 0.77 | 0.38 | 0.50 | 0.08 | 0.40 | 0.48 | 0.06 |

Intersection Summary

Cycle Length: 120
 Actuated Cycle Length: 120
 Offset: 64 (53%), Referenced to phase 2:NBTL and 6:SBTL, Start of Green
 Natural Cycle: 85
 Control Type: Actuated-Coordinated
 Maximum v/c Ratio: 0.80
 Intersection Signal Delay: 35.3
 Intersection Capacity Utilization 98.0%
 Analysis Period (min) 15
 m Volume for 95th percentile queue is metered by upstream signal.

Intersection LOS: D
 ICU Level of Service F

Splits and Phases: 9: Robie & Coburg/Spring Garden

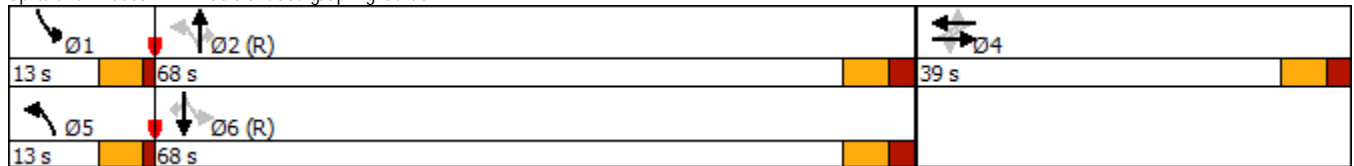

| Lane Group | EBL | EBT | WBL | WBT | WBR | NBL | NBT | NBR | SBL | SBT | SBR |
|------------------------|-------|-------|-------|-------|-------|-------|-------|-------|-------|-------|-------|
| Lane Configurations | | | | | | | | | | | |
| Traffic Volume (vph) | 45 | 100 | 25 | 145 | 225 | 30 | 659 | 30 | 135 | 263 | 45 |
| Future Volume (vph) | 45 | 100 | 25 | 145 | 225 | 30 | 659 | 30 | 135 | 263 | 45 |
| Lane Group Flow (vph) | 51 | 137 | 29 | 165 | 257 | 34 | 752 | 34 | 154 | 300 | 51 |
| Turn Type | Perm | NA | Perm | NA | Perm | Perm | NA | Perm | pm+pt | NA | Perm |
| Protected Phases | | 8 | | 4 | | | 6 | | 5 | 2 | |
| Permitted Phases | 8 | | 4 | | 4 | 6 | | 6 | 2 | | 2 |
| Detector Phase | 8 | 8 | 4 | 4 | 4 | 6 | 6 | 6 | 5 | 2 | 2 |
| Switch Phase | | | | | | | | | | | |
| Minimum Initial (s) | 10.0 | 10.0 | 10.0 | 10.0 | 10.0 | 10.0 | 10.0 | 10.0 | 8.0 | 10.0 | 10.0 |
| Minimum Split (s) | 32.5 | 32.5 | 32.5 | 32.5 | 32.5 | 43.3 | 43.3 | 43.3 | 13.0 | 43.3 | 43.3 |
| Total Split (s) | 34.0 | 34.0 | 34.0 | 34.0 | 34.0 | 63.0 | 63.0 | 63.0 | 13.0 | 76.0 | 76.0 |
| Total Split (%) | 30.9% | 30.9% | 30.9% | 30.9% | 30.9% | 57.3% | 57.3% | 57.3% | 11.8% | 69.1% | 69.1% |
| Yellow Time (s) | 4.1 | 4.1 | 4.1 | 4.1 | 4.1 | 4.1 | 4.1 | 4.1 | 4.0 | 4.1 | 4.1 |
| All-Red Time (s) | 2.4 | 2.4 | 2.4 | 2.4 | 2.4 | 3.2 | 3.2 | 3.2 | 0.0 | 3.2 | 3.2 |
| Lost Time Adjust (s) | 0.0 | 0.0 | 0.0 | 0.0 | 0.0 | 0.0 | 0.0 | 0.0 | 0.0 | 0.0 | 0.0 |
| Total Lost Time (s) | 6.5 | 6.5 | 6.5 | 6.5 | 6.5 | 7.3 | 7.3 | 7.3 | 4.0 | 7.3 | 7.3 |
| Lead/Lag | | | | | | Lag | Lag | Lag | Lead | | |
| Lead-Lag Optimize? | | | | | | | | | | | |
| Recall Mode | Ped | Ped | Ped | Ped | Ped | C-Min | C-Min | C-Min | None | C-Min | C-Min |
| Act Effct Green (s) | 26.4 | 26.4 | 26.4 | 26.4 | 26.4 | 56.5 | 56.5 | 56.5 | 73.1 | 69.8 | 69.8 |
| Actuated g/C Ratio | 0.24 | 0.24 | 0.24 | 0.24 | 0.24 | 0.51 | 0.51 | 0.51 | 0.66 | 0.63 | 0.63 |
| v/c Ratio | 0.27 | 0.36 | 0.12 | 0.42 | 0.64 | 0.07 | 0.49 | 0.04 | 0.35 | 0.31 | 0.07 |
| Control Delay | 38.5 | 35.4 | 34.0 | 39.2 | 12.4 | 12.8 | 16.1 | 12.4 | 9.2 | 10.3 | 4.0 |
| Queue Delay | 0.0 | 0.0 | 0.0 | 0.0 | 0.0 | 0.0 | 0.0 | 0.0 | 0.0 | 0.0 | 0.0 |
| Total Delay | 38.5 | 35.4 | 34.0 | 39.2 | 12.4 | 12.8 | 16.1 | 12.4 | 9.2 | 10.3 | 4.0 |
| LOS | D | D | C | D | B | B | B | B | A | B | A |
| Approach Delay | | 36.2 | | 23.6 | | | 15.8 | | | 9.3 | |
| Approach LOS | | D | | C | | | B | | | A | |
| Queue Length 50th (m) | 9.0 | 23.0 | 4.9 | 30.2 | 0.0 | 3.3 | 45.3 | 3.2 | 10.9 | 26.7 | 1.2 |
| Queue Length 95th (m) | 19.7 | 39.8 | 12.5 | 49.1 | 25.1 | m6.2 | m62.4 | m6.1 | 19.4 | 43.3 | 5.7 |
| Internal Link Dist (m) | | 178.0 | | 171.4 | | | 167.5 | | | 240.3 | |
| Turn Bay Length (m) | 15.0 | | 15.0 | | 60.0 | 60.0 | | | 60.0 | | |
| Base Capacity (vph) | 195 | 400 | 259 | 407 | 408 | 493 | 1554 | 799 | 439 | 963 | 725 |
| Starvation Cap Reductn | 0 | 0 | 0 | 0 | 0 | 0 | 0 | 0 | 0 | 0 | 0 |
| Spillback Cap Reductn | 0 | 0 | 0 | 0 | 0 | 0 | 0 | 0 | 0 | 0 | 0 |
| Storage Cap Reductn | 0 | 0 | 0 | 0 | 0 | 0 | 0 | 0 | 0 | 0 | 0 |
| Reduced v/c Ratio | 0.26 | 0.34 | 0.11 | 0.41 | 0.63 | 0.07 | 0.48 | 0.04 | 0.35 | 0.31 | 0.07 |

Intersection Summary

Cycle Length: 110
 Actuated Cycle Length: 110
 Offset: 0 (0%), Referenced to phase 2:SBTL and 6:NBT, Start of Green
 Natural Cycle: 90
 Control Type: Actuated-Coordinated
 Maximum v/c Ratio: 0.64
 Intersection Signal Delay: 17.9
 Intersection Capacity Utilization 91.3%
 Analysis Period (min) 15
 m Volume for 95th percentile queue is metered by upstream signal.

Intersection LOS: B
 ICU Level of Service F

Splits and Phases: 10: Robie & University

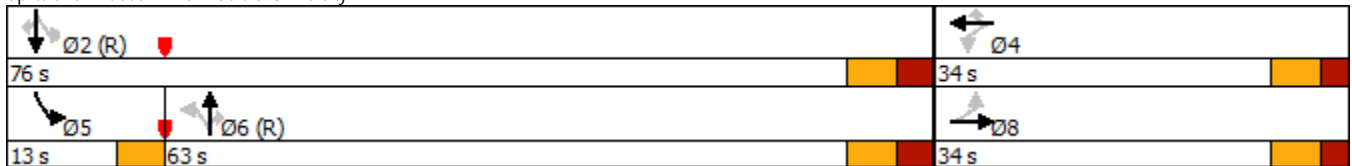

| Lane Group | EBL | EBT | WBL | WBT | NBL | NBT | NBR | SBL | SBT | SBR |
|------------------------|-------|-------|-------|--------|-------|-------|-------|-------|-------|-------|
| Lane Configurations | | | | | | | | | | |
| Traffic Volume (vph) | 55 | 205 | 20 | 345 | 45 | 326 | 15 | 95 | 263 | 50 |
| Future Volume (vph) | 55 | 205 | 20 | 345 | 45 | 326 | 15 | 95 | 263 | 50 |
| Lane Group Flow (vph) | 0 | 320 | 0 | 697 | 51 | 372 | 17 | 108 | 300 | 57 |
| Turn Type | Perm | NA | Perm | NA | Perm | NA | Perm | Perm | NA | Perm |
| Protected Phases | | 4 | | 4 | | 2 | | | 6 | |
| Permitted Phases | 4 | | 4 | | 2 | | 2 | 6 | | 6 |
| Detector Phase | 4 | 4 | 4 | 4 | 2 | 2 | 2 | 6 | 6 | 6 |
| Switch Phase | | | | | | | | | | |
| Minimum Initial (s) | 10.0 | 10.0 | 10.0 | 10.0 | 10.0 | 10.0 | 10.0 | 10.0 | 10.0 | 10.0 |
| Minimum Split (s) | 47.8 | 47.8 | 47.8 | 47.8 | 24.7 | 24.7 | 24.7 | 24.7 | 24.7 | 24.7 |
| Total Split (s) | 53.0 | 53.0 | 53.0 | 53.0 | 57.0 | 57.0 | 57.0 | 57.0 | 57.0 | 57.0 |
| Total Split (%) | 48.2% | 48.2% | 48.2% | 48.2% | 51.8% | 51.8% | 51.8% | 51.8% | 51.8% | 51.8% |
| Yellow Time (s) | 4.1 | 4.1 | 4.1 | 4.1 | 4.1 | 4.1 | 4.1 | 4.1 | 4.1 | 4.1 |
| All-Red Time (s) | 2.7 | 2.7 | 2.7 | 2.7 | 1.6 | 1.6 | 1.6 | 1.6 | 1.6 | 1.6 |
| Lost Time Adjust (s) | | 0.0 | | 0.0 | 0.0 | 0.0 | 0.0 | 0.0 | 0.0 | 0.0 |
| Total Lost Time (s) | | 6.8 | | 6.8 | 5.7 | 5.7 | 5.7 | 5.7 | 5.7 | 5.7 |
| Lead/Lag | | | | | | | | | | |
| Lead-Lag Optimize? | | | | | | | | | | |
| Recall Mode | Ped | Ped | Ped | Ped | C-Min | C-Min | C-Min | C-Min | C-Min | C-Min |
| Act Effct Green (s) | | 52.2 | | 52.2 | 45.3 | 45.3 | 45.3 | 45.3 | 45.3 | 45.3 |
| Actuated g/C Ratio | | 0.47 | | 0.47 | 0.41 | 0.41 | 0.41 | 0.41 | 0.41 | 0.41 |
| v/c Ratio | | 0.58 | | 0.88 | 0.18 | 0.54 | 0.04 | 0.42 | 0.48 | 0.13 |
| Control Delay | | 25.1 | | 38.0 | 23.8 | 28.9 | 2.1 | 26.9 | 23.9 | 4.3 |
| Queue Delay | | 0.0 | | 0.0 | 0.0 | 0.0 | 0.0 | 0.0 | 0.0 | 0.0 |
| Total Delay | | 25.1 | | 38.0 | 23.8 | 28.9 | 2.1 | 26.9 | 23.9 | 4.3 |
| LOS | | C | | D | C | C | A | C | C | A |
| Approach Delay | | 25.1 | | 38.0 | | 27.2 | | | 22.2 | |
| Approach LOS | | C | | D | | C | | | C | |
| Queue Length 50th (m) | | 47.7 | | 125.4 | 6.8 | 59.3 | 0.0 | 17.3 | 49.5 | 0.0 |
| Queue Length 95th (m) | | 71.6 | | #178.1 | 16.3 | 93.1 | 1.6 | 35.8 | 78.4 | 9.1 |
| Internal Link Dist (m) | | 115.5 | | 183.6 | | 422.3 | | | 167.5 | |
| Turn Bay Length (m) | | | | | 40.0 | | | 60.0 | | |
| Base Capacity (vph) | | 556 | | 795 | 327 | 774 | 524 | 288 | 707 | 484 |
| Starvation Cap Reductn | | 0 | | 0 | 0 | 0 | 0 | 0 | 0 | 0 |
| Spillback Cap Reductn | | 0 | | 0 | 0 | 0 | 0 | 0 | 0 | 0 |
| Storage Cap Reductn | | 0 | | 0 | 0 | 0 | 0 | 0 | 0 | 0 |
| Reduced v/c Ratio | | 0.58 | | 0.88 | 0.16 | 0.48 | 0.03 | 0.38 | 0.42 | 0.12 |

Intersection Summary

Cycle Length: 110
 Actuated Cycle Length: 110
 Offset: 0 (0%), Referenced to phase 2:NBT and 6:SBTL, Start of Green
 Natural Cycle: 75
 Control Type: Actuated-Coordinated
 Maximum v/c Ratio: 0.88
 Intersection Signal Delay: 29.6
 Intersection Capacity Utilization 82.2%
 Analysis Period (min) 15
 # 95th percentile volume exceeds capacity, queue may be longer.
 Queue shown is maximum after two cycles.

Splits and Phases: 11: Robie & South

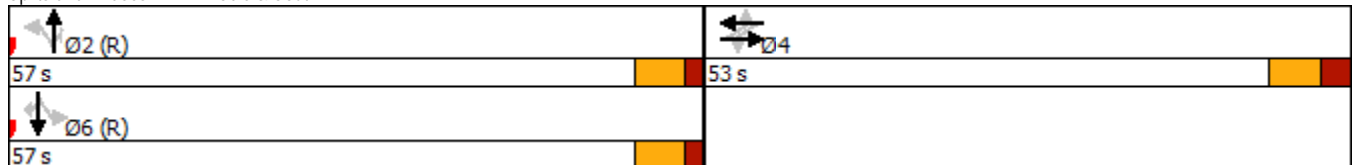

| Lane Group | EBL | EBT | WBL | WBT | WBR | NBL | NBT | SBL | SBT | SBR |
|------------------------|-------|-------|-------|-------|--------|-------|-------|-------|-------|-------|
| Lane Configurations | | | | | | | | | | |
| Traffic Volume (vph) | 20 | 235 | 80 | 275 | 275 | 30 | 125 | 175 | 70 | 15 |
| Future Volume (vph) | 20 | 235 | 80 | 275 | 275 | 30 | 125 | 175 | 70 | 15 |
| Lane Group Flow (vph) | 0 | 320 | 0 | 405 | 314 | 0 | 268 | 200 | 80 | 17 |
| Turn Type | Perm | NA | Perm | NA | custom | Perm | NA | pm+pt | NA | Perm |
| Protected Phases | | 8 | | 4 | | | 6 | 5 | 2 | |
| Permitted Phases | 8 | | 4 | | 4 5 | 6 | | 2 | | 2 |
| Detector Phase | 8 | 8 | 4 | 4 | 4 5 | 6 | 6 | 5 | 2 | 2 |
| Switch Phase | | | | | | | | | | |
| Minimum Initial (s) | 10.0 | 10.0 | 10.0 | 10.0 | | 10.0 | 10.0 | 8.0 | 10.0 | 10.0 |
| Minimum Split (s) | 31.7 | 31.7 | 31.7 | 31.7 | | 23.1 | 23.1 | 11.0 | 23.1 | 23.1 |
| Total Split (s) | 40.0 | 40.0 | 40.0 | 40.0 | | 39.0 | 39.0 | 11.0 | 50.0 | 50.0 |
| Total Split (%) | 44.4% | 44.4% | 44.4% | 44.4% | | 43.3% | 43.3% | 12.2% | 55.6% | 55.6% |
| Yellow Time (s) | 4.1 | 4.1 | 4.1 | 4.1 | | 4.1 | 4.1 | 3.0 | 4.1 | 4.1 |
| All-Red Time (s) | 2.6 | 2.6 | 2.6 | 2.6 | | 2.0 | 2.0 | 0.0 | 2.0 | 2.0 |
| Lost Time Adjust (s) | | 0.0 | | 0.0 | | | 0.0 | 0.0 | 0.0 | 0.0 |
| Total Lost Time (s) | | 6.7 | | 6.7 | | | 6.1 | 3.0 | 6.1 | 6.1 |
| Lead/Lag | | | | | | Lag | Lag | Lead | | |
| Lead-Lag Optimize? | | | | | | | | | | |
| Recall Mode | Ped | Ped | Max | Max | | C-Min | C-Min | None | C-Min | C-Min |
| Act Effct Green (s) | | 53.8 | | 53.8 | 64.8 | | 12.4 | 26.5 | 23.4 | 23.4 |
| Actuated g/C Ratio | | 0.60 | | 0.60 | 0.72 | | 0.14 | 0.29 | 0.26 | 0.26 |
| v/c Ratio | | 0.31 | | 0.47 | 0.28 | | 0.62 | 0.70 | 0.20 | 0.05 |
| Control Delay | | 10.3 | | 12.9 | 1.3 | | 30.2 | 39.3 | 26.5 | 1.4 |
| Queue Delay | | 0.0 | | 0.0 | 0.0 | | 0.0 | 0.0 | 0.0 | 0.0 |
| Total Delay | | 10.3 | | 12.9 | 1.3 | | 30.2 | 39.3 | 26.5 | 1.4 |
| LOS | | B | | B | A | | C | D | C | A |
| Approach Delay | | 10.3 | | 7.8 | | | 30.2 | | 33.7 | |
| Approach LOS | | B | | A | | | C | | C | |
| Queue Length 50th (m) | | 24.0 | | 35.1 | 0.0 | | 15.2 | 28.0 | 10.9 | 0.0 |
| Queue Length 95th (m) | | 44.2 | | 64.9 | 7.3 | | 26.1 | 43.4 | 20.7 | 1.1 |
| Internal Link Dist (m) | | 113.9 | | 142.4 | | | 118.8 | | 422.3 | |
| Turn Bay Length (m) | | | | | 50.0 | | | | | 20.0 |
| Base Capacity (vph) | | 1025 | | 864 | 1112 | | 993 | 287 | 756 | 576 |
| Starvation Cap Reductn | | 0 | | 0 | 0 | | 0 | 0 | 0 | 0 |
| Spillback Cap Reductn | | 0 | | 0 | 0 | | 0 | 0 | 0 | 0 |
| Storage Cap Reductn | | 0 | | 0 | 0 | | 0 | 0 | 0 | 0 |
| Reduced v/c Ratio | | 0.31 | | 0.47 | 0.28 | | 0.27 | 0.70 | 0.11 | 0.03 |

Intersection Summary

Cycle Length: 90
 Actuated Cycle Length: 90
 Offset: 0 (0%), Referenced to phase 2:SBTL and 6:NBT, Start of Green
 Natural Cycle: 70
 Control Type: Actuated-Coordinated
 Maximum v/c Ratio: 0.70
 Intersection Signal Delay: 16.8
 Intersection Capacity Utilization 85.9%
 Analysis Period (min) 15

Intersection LOS: B
 ICU Level of Service E

Splits and Phases: 12: Robie & Inglis

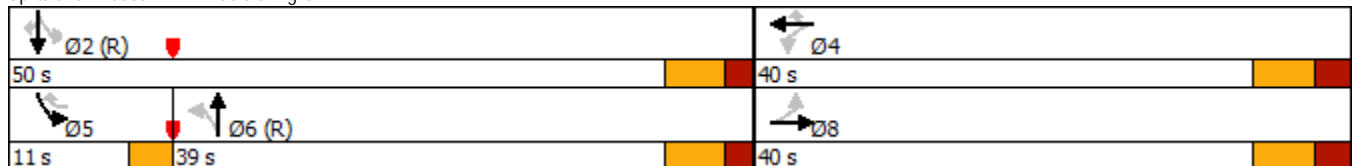

| Lane Group | EBL | EBT | WBL | WBT | WBR | NBL | NBT | SBL | SBT |
|------------------------|-------|-------|-------|-------|-------|-------|-------|-------|--------|
| Lane Configurations | | | | | | | | | |
| Traffic Volume (vph) | 150 | 290 | 20 | 195 | 45 | 30 | 9 | 40 | 573 |
| Future Volume (vph) | 150 | 290 | 20 | 195 | 45 | 30 | 9 | 40 | 573 |
| Lane Group Flow (vph) | 171 | 388 | 0 | 246 | 51 | 34 | 10 | 46 | 888 |
| Turn Type | pm+pt | NA | Perm | NA | Perm | Prot | NA | Prot | NA |
| Protected Phases | 3 | 8 | | 4 | | 1 | 2 | 1 | 2 |
| Permitted Phases | 8 | | 4 | | 4 | | | | |
| Detector Phase | 3 | 8 | 4 | 4 | 4 | 1 | 2 | 1 | 2 |
| Switch Phase | | | | | | | | | |
| Minimum Initial (s) | 7.0 | 10.0 | 10.0 | 10.0 | 10.0 | 8.0 | 10.0 | 8.0 | 10.0 |
| Minimum Split (s) | 11.0 | 50.0 | 37.0 | 37.0 | 37.0 | 13.0 | 40.0 | 13.0 | 40.0 |
| Total Split (s) | 13.0 | 51.0 | 38.0 | 38.0 | 38.0 | 13.0 | 56.0 | 13.0 | 56.0 |
| Total Split (%) | 10.8% | 42.5% | 31.7% | 31.7% | 31.7% | 10.8% | 46.7% | 10.8% | 46.7% |
| Yellow Time (s) | 4.0 | 4.1 | 4.1 | 4.1 | 4.1 | 4.0 | 4.1 | 4.0 | 4.1 |
| All-Red Time (s) | 0.0 | 2.1 | 2.1 | 2.1 | 2.1 | 1.0 | 1.7 | 1.0 | 1.7 |
| Lost Time Adjust (s) | 0.0 | 0.0 | | 0.0 | 0.0 | 0.0 | 0.0 | 0.0 | 0.0 |
| Total Lost Time (s) | 4.0 | 6.2 | | 6.2 | 6.2 | 5.0 | 5.8 | 5.0 | 5.8 |
| Lead/Lag | Lead | | Lag | Lag | Lag | Lead | Lag | Lead | Lag |
| Lead-Lag Optimize? | | | | | | | | | |
| Recall Mode | None | None | None | None | None | None | C-Min | None | C-Min |
| Act Effct Green (s) | 35.5 | 33.3 | | 20.3 | 20.3 | 9.1 | 63.2 | 9.1 | 63.2 |
| Actuated g/C Ratio | 0.30 | 0.28 | | 0.17 | 0.17 | 0.08 | 0.53 | 0.08 | 0.53 |
| v/c Ratio | 0.74 | 0.79 | | 0.76 | 0.16 | 0.25 | 0.01 | 0.35 | 1.00 |
| Control Delay | 52.3 | 50.9 | | 62.2 | 1.0 | 56.5 | 18.2 | 67.0 | 46.0 |
| Queue Delay | 0.0 | 0.0 | | 0.0 | 0.0 | 0.0 | 0.0 | 0.0 | 0.0 |
| Total Delay | 52.3 | 50.9 | | 62.2 | 1.0 | 56.5 | 18.2 | 67.0 | 46.0 |
| LOS | D | D | | E | A | E | B | E | D |
| Approach Delay | | 51.3 | | 51.7 | | | 47.8 | | 47.0 |
| Approach LOS | | D | | D | | | D | | D |
| Queue Length 50th (m) | 31.7 | 83.5 | | 56.1 | 0.0 | 7.7 | 1.1 | 11.1 | -222.0 |
| Queue Length 95th (m) | 45.4 | 107.8 | | 76.7 | 0.0 | 17.7 | 4.7 | m18.2 | #327.7 |
| Internal Link Dist (m) | | 253.6 | | 227.2 | | | 402.8 | | 360.9 |
| Turn Bay Length (m) | 80.0 | | | | 50.0 | | | 180.0 | |
| Base Capacity (vph) | 231 | 660 | | 508 | 447 | 134 | 923 | 131 | 892 |
| Starvation Cap Reductn | 0 | 0 | | 0 | 0 | 0 | 0 | 0 | 0 |
| Spillback Cap Reductn | 0 | 0 | | 0 | 0 | 0 | 0 | 0 | 0 |
| Storage Cap Reductn | 0 | 0 | | 0 | 0 | 0 | 0 | 0 | 0 |
| Reduced v/c Ratio | 0.74 | 0.59 | | 0.48 | 0.11 | 0.25 | 0.01 | 0.35 | 1.00 |

Intersection Summary

Cycle Length: 120
 Actuated Cycle Length: 120
 Offset: 78 (65%), Referenced to phase 2:NBSB and 6:, Start of Green
 Natural Cycle: 125
 Control Type: Actuated-Coordinated
 Maximum v/c Ratio: 1.00
 Intersection Signal Delay: 49.1
 Intersection Capacity Utilization 120.7%
 Analysis Period (min) 15
 ~ Volume exceeds capacity, queue is theoretically infinite.
 Queue shown is maximum after two cycles.
 # 95th percentile volume exceeds capacity, queue may be longer.
 Queue shown is maximum after two cycles.
 m Volume for 95th percentile queue is metered by upstream signal.

Splits and Phases: 4: Robie & Almon

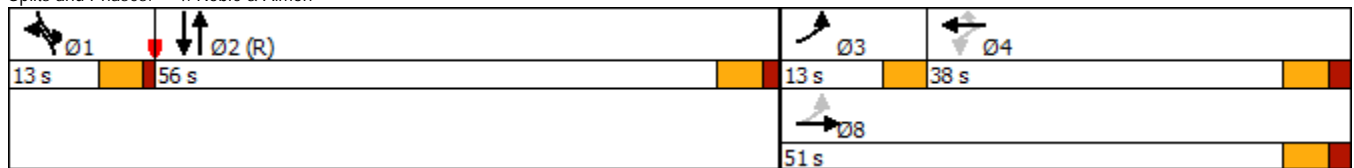

| | → | ← | ↑ | ↓ |
|------------------------|-------|-------|-------|-------|
| Lane Group | EBT | WBT | NBT | SBT |
| Lane Configurations | ↗ | ↖ | ↑ | ↘ |
| Traffic Volume (vph) | 375 | 420 | 9 | 553 |
| Future Volume (vph) | 375 | 420 | 9 | 553 |
| Lane Group Flow (vph) | 457 | 490 | 10 | 642 |
| Turn Type | NA | NA | NA | NA |
| Protected Phases | 8 | 4 | 2 | 2 |
| Permitted Phases | | | | |
| Detector Phase | 8 | 4 | 2 | 2 |
| Switch Phase | | | | |
| Minimum Initial (s) | 10.0 | 10.0 | 10.0 | 10.0 |
| Minimum Split (s) | 23.7 | 23.7 | 49.0 | 49.0 |
| Total Split (s) | 40.0 | 40.0 | 50.0 | 50.0 |
| Total Split (%) | 44.4% | 44.4% | 55.6% | 55.6% |
| Yellow Time (s) | 4.1 | 4.1 | 4.1 | 4.1 |
| All-Red Time (s) | 1.6 | 1.6 | 1.5 | 1.5 |
| Lost Time Adjust (s) | 0.0 | 0.0 | 0.0 | 0.0 |
| Total Lost Time (s) | 5.7 | 5.7 | 5.6 | 5.6 |
| Lead/Lag | | | | |
| Lead-Lag Optimize? | | | | |
| Recall Mode | Ped | Ped | C-Min | C-Min |
| Act Effct Green (s) | 28.6 | 28.6 | 50.1 | 50.1 |
| Actuated g/C Ratio | 0.32 | 0.32 | 0.56 | 0.56 |
| v/c Ratio | 0.81 | 0.83 | 0.01 | 0.65 |
| Control Delay | 39.7 | 40.6 | 11.2 | 19.0 |
| Queue Delay | 0.0 | 0.0 | 0.0 | 0.0 |
| Total Delay | 39.7 | 40.6 | 11.2 | 19.0 |
| LOS | D | D | B | B |
| Approach Delay | 39.7 | 40.6 | 11.2 | 19.0 |
| Approach LOS | D | D | B | B |
| Queue Length 50th (m) | 70.0 | 76.1 | 0.8 | 74.3 |
| Queue Length 95th (m) | 97.5 | 104.2 | 3.4 | 125.4 |
| Internal Link Dist (m) | 171.5 | 199.1 | 446.6 | 402.8 |
| Turn Bay Length (m) | | | | |
| Base Capacity (vph) | 673 | 708 | 969 | 992 |
| Starvation Cap Reductn | 0 | 0 | 0 | 0 |
| Spillback Cap Reductn | 0 | 0 | 0 | 0 |
| Storage Cap Reductn | 0 | 0 | 0 | 0 |
| Reduced v/c Ratio | 0.68 | 0.69 | 0.01 | 0.65 |

Intersection Summary

Cycle Length: 90
 Actuated Cycle Length: 90
 Offset: 0 (0%), Referenced to phase 2:NBSB, Start of Green
 Natural Cycle: 80
 Control Type: Actuated-Coordinated
 Maximum v/c Ratio: 0.83
 Intersection Signal Delay: 31.5
 Intersection Capacity Utilization 69.6%
 Analysis Period (min) 15

Intersection LOS: C
 ICU Level of Service C

Splits and Phases: 5: Robie & North

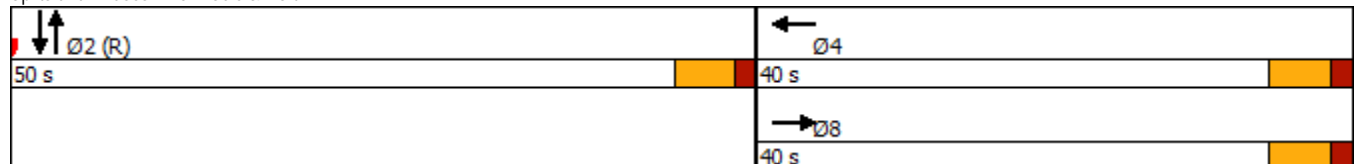

| Lane Group | EBL | EBT | WBL2 | WBT | WBR | NBL2 | NBL | NBT | SBL | SBT |
|------------------------|-------|--------|-------|-------|-------|-------|-------|-------|-------|--------|
| Lane Configurations | | | | | | | | | | |
| Traffic Volume (vph) | 10 | 410 | 40 | 160 | 40 | 50 | 6 | 9 | 75 | 643 |
| Future Volume (vph) | 10 | 410 | 40 | 160 | 40 | 50 | 6 | 9 | 75 | 643 |
| Lane Group Flow (vph) | 11 | 571 | 46 | 183 | 46 | 51 | 0 | 23 | 86 | 745 |
| Turn Type | Perm | NA | Perm | NA | Perm | Prot | Perm | NA | Prot | NA |
| Protected Phases | | 8 | | 4 | | 9 | | 2 | 1 | 6 |
| Permitted Phases | 8 | | 4 | | 4 | | 2 | | | |
| Detector Phase | 8 | 8 | 4 | 4 | 4 | 9 | 2 | 2 | 1 | 6 |
| Switch Phase | | | | | | | | | | |
| Minimum Initial (s) | 10.0 | 10.0 | 10.0 | 10.0 | 10.0 | 8.0 | 10.0 | 10.0 | 8.0 | 8.0 |
| Minimum Split (s) | 39.1 | 39.1 | 39.1 | 39.1 | 39.1 | 13.0 | 37.9 | 37.9 | 13.0 | 24.0 |
| Total Split (s) | 49.0 | 49.0 | 49.0 | 49.0 | 49.0 | 15.0 | 56.0 | 56.0 | 15.0 | 56.0 |
| Total Split (%) | 40.8% | 40.8% | 40.8% | 40.8% | 40.8% | 12.5% | 46.7% | 46.7% | 12.5% | 46.7% |
| Yellow Time (s) | 4.1 | 4.1 | 4.1 | 4.1 | 4.1 | 4.0 | 4.1 | 4.1 | 4.0 | 4.0 |
| All-Red Time (s) | 3.0 | 3.0 | 3.0 | 3.0 | 3.0 | 1.0 | 2.0 | 2.0 | 1.0 | 2.0 |
| Lost Time Adjust (s) | 0.0 | 0.0 | 0.0 | 0.0 | 0.0 | 0.0 | | 0.0 | 0.0 | 0.0 |
| Total Lost Time (s) | 7.1 | 7.1 | 7.1 | 7.1 | 7.1 | 5.0 | | 6.1 | 5.0 | 6.0 |
| Lead/Lag | | | | | | | Lag | Lag | Lead | |
| Lead-Lag Optimize? | | | | | | | | | | |
| Recall Mode | Ped | Ped | Ped | Ped | Ped | None | C-Min | C-Min | None | C-Min |
| Act Effct Green (s) | 44.8 | 44.8 | 44.8 | 44.8 | 44.8 | 9.0 | | 47.5 | 9.5 | 50.7 |
| Actuated g/C Ratio | 0.37 | 0.37 | 0.37 | 0.37 | 0.37 | 0.08 | | 0.40 | 0.08 | 0.42 |
| v/c Ratio | 0.04 | 1.06 | 0.41 | 0.27 | 0.09 | 0.41 | | 0.06 | 0.63 | 0.91 |
| Control Delay | 26.4 | 93.2 | 43.8 | 28.7 | 2.5 | 63.0 | | 21.8 | 73.7 | 45.9 |
| Queue Delay | 0.0 | 0.0 | 0.0 | 0.0 | 0.0 | 0.0 | | 0.0 | 0.0 | 0.0 |
| Total Delay | 26.4 | 93.2 | 43.8 | 28.7 | 2.5 | 63.0 | | 21.8 | 73.7 | 45.9 |
| LOS | C | F | D | C | A | E | | C | E | D |
| Approach Delay | | 92.0 | | 26.8 | | | | 50.2 | | 48.8 |
| Approach LOS | | F | | C | | | | D | | D |
| Queue Length 50th (m) | 1.7 | #156.3 | 8.3 | 31.0 | 0.0 | 12.3 | | 3.3 | 19.9 | 147.3 |
| Queue Length 95th (m) | 5.9 | #222.9 | 21.4 | 49.3 | 3.4 | 25.6 | | 8.9 | #39.6 | #227.8 |
| Internal Link Dist (m) | | 72.7 | | 213.1 | | | | 402.3 | | 446.6 |
| Turn Bay Length (m) | 50.0 | | | | 50.0 | 40.0 | | | 40.0 | |
| Base Capacity (vph) | 313 | 539 | 112 | 680 | 535 | 138 | | 385 | 144 | 817 |
| Starvation Cap Reductn | 0 | 0 | 0 | 0 | 0 | 0 | | 0 | 0 | 0 |
| Spillback Cap Reductn | 0 | 0 | 0 | 0 | 0 | 0 | | 0 | 0 | 0 |
| Storage Cap Reductn | 0 | 0 | 0 | 0 | 0 | 0 | | 0 | 0 | 0 |
| Reduced v/c Ratio | 0.04 | 1.06 | 0.41 | 0.27 | 0.09 | 0.37 | | 0.06 | 0.60 | 0.91 |

Intersection Summary

Cycle Length: 120
 Actuated Cycle Length: 120
 Offset: 0 (0%), Referenced to phase 2:NBT and 6:SBT, Start of Green
 Natural Cycle: 120
 Control Type: Actuated-Coordinated
 Maximum v/c Ratio: 1.06
 Intersection Signal Delay: 59.7
 Intersection Capacity Utilization 82.0%
 Analysis Period (min) 15
 ~ Volume exceeds capacity, queue is theoretically infinite.
 Queue shown is maximum after two cycles.
 # 95th percentile volume exceeds capacity, queue may be longer.
 Queue shown is maximum after two cycles.

Splits and Phases: 6: Robie & Cunard

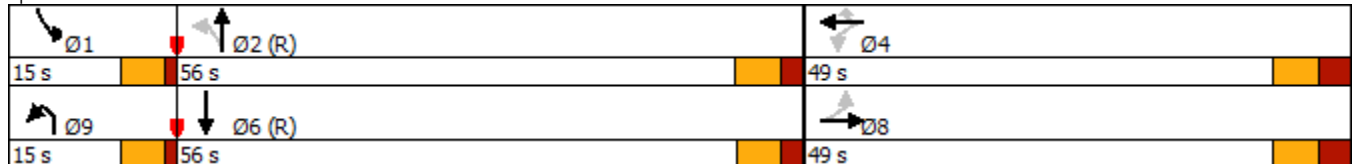

| Lane Group | EBT | EBR | EBR2 | WBT | NBL | NBT | SBL | SBT | NWL |
|------------------------|--------|-------|--------|-------|--------|-------|--------|--------|-------|
| Lane Configurations | | | | | | | | | |
| Traffic Volume (vph) | 410 | 470 | 400 | 205 | 150 | 15 | 238 | 710 | 245 |
| Future Volume (vph) | 410 | 470 | 400 | 205 | 150 | 15 | 238 | 710 | 245 |
| Lane Group Flow (vph) | 468 | 536 | 457 | 268 | 171 | 17 | 350 | 861 | 406 |
| Turn Type | NA | pt+ov | Perm | NA | Prot | NA | Prot | NA | Prot |
| Protected Phases | 7 | 7 8 | | 7 | 1 | 6 | 5 | 2 | 8 |
| Permitted Phases | | | 7 | | | | | | |
| Minimum Split (s) | 37.0 | | 37.0 | 37.0 | 14.0 | 36.0 | 14.0 | 44.0 | 36.0 |
| Total Split (s) | 44.0 | | 44.0 | 44.0 | 18.0 | 37.0 | 33.0 | 52.0 | 36.0 |
| Total Split (%) | 29.3% | | 29.3% | 29.3% | 12.0% | 24.7% | 22.0% | 34.7% | 24.0% |
| Yellow Time (s) | 4.0 | | 4.0 | 4.0 | 4.0 | 4.0 | 4.0 | 4.0 | 4.0 |
| All-Red Time (s) | 4.0 | | 4.0 | 4.0 | 1.0 | 3.0 | 1.0 | 3.0 | 4.0 |
| Lost Time Adjust (s) | -1.0 | | -1.0 | -1.0 | -1.0 | -1.0 | -1.0 | -1.0 | -1.0 |
| Total Lost Time (s) | 7.0 | | 7.0 | 7.0 | 4.0 | 6.0 | 4.0 | 6.0 | 7.0 |
| Lead/Lag | Lead | | Lead | Lead | Lead | Lag | Lead | Lag | Lag |
| Lead-Lag Optimize? | | | | | | | | | |
| Act Effct Green (s) | 37.0 | 73.0 | 37.0 | 37.0 | 14.0 | 31.0 | 29.0 | 46.0 | 29.0 |
| Actuated g/C Ratio | 0.25 | 0.49 | 0.25 | 0.25 | 0.09 | 0.21 | 0.19 | 0.31 | 0.19 |
| v/c Ratio | 1.05 | 0.72 | 0.87 | 0.32 | 1.06 | 0.05 | 1.07 | 0.91 | 0.73 |
| Control Delay | 110.2 | 37.1 | 38.9 | 45.8 | 148.9 | 48.4 | 126.4 | 64.7 | 65.5 |
| Queue Delay | 0.0 | 0.0 | 0.0 | 0.0 | 0.0 | 0.0 | 0.0 | 0.0 | 0.0 |
| Total Delay | 110.2 | 37.1 | 38.9 | 45.8 | 148.9 | 48.4 | 126.4 | 64.7 | 65.5 |
| LOS | F | D | D | D | F | D | F | E | E |
| Approach Delay | 61.0 | | | 45.8 | | 139.8 | | 82.5 | 65.5 |
| Approach LOS | E | | | D | | F | | F | E |
| Queue Length 50th (m) | -151.2 | 123.4 | 57.7 | 33.3 | -55.3 | 4.1 | -115.0 | 129.7 | 59.1 |
| Queue Length 95th (m) | #219.0 | 169.4 | #121.3 | 46.6 | #102.8 | 11.0 | #177.3 | #167.1 | 77.7 |
| Internal Link Dist (m) | 112.3 | | | 207.4 | | 413.3 | | 402.3 | 600.3 |
| Turn Bay Length (m) | | 70.0 | 70.0 | | | | 80.0 | | |
| Base Capacity (vph) | 445 | 747 | 525 | 828 | 162 | 350 | 326 | 942 | 556 |
| Starvation Cap Reductn | 0 | 0 | 0 | 0 | 0 | 0 | 0 | 0 | 0 |
| Spillback Cap Reductn | 0 | 0 | 0 | 0 | 0 | 0 | 0 | 0 | 0 |
| Storage Cap Reductn | 0 | 0 | 0 | 0 | 0 | 0 | 0 | 0 | 0 |
| Reduced v/c Ratio | 1.05 | 0.72 | 0.87 | 0.32 | 1.06 | 0.05 | 1.07 | 0.91 | 0.73 |

Intersection Summary

Cycle Length: 150
 Actuated Cycle Length: 150
 Offset: 0 (0%), Referenced to phase 2:SBT and 6:NBT, Start of Green
 Natural Cycle: 135
 Control Type: Pretimed
 Maximum v/c Ratio: 1.07
 Intersection Signal Delay: 71.9
 Intersection Capacity Utilization 111.2%
 Analysis Period (min) 15
 Intersection LOS: E
 ICU Level of Service H

- Volume exceeds capacity, queue is theoretically infinite.
 Queue shown is maximum after two cycles.
 # 95th percentile volume exceeds capacity, queue may be longer.
 Queue shown is maximum after two cycles.

Splits and Phases: 7: Robie & Bell & Quinpool/Cogswell

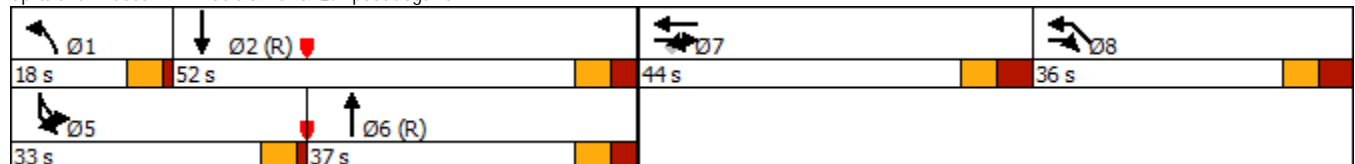

| Lane Group | EBL | EBT | WBL | WBT | WBR | NBL | NBT | SBL | SBT |
|------------------------|-------|--------|-------|-------|-------|-------|-------|-------|-------|
| Lane Configurations | | | | | | | | | |
| Traffic Volume (vph) | 65 | 275 | 20 | 105 | 95 | 45 | 15 | 195 | 885 |
| Future Volume (vph) | 65 | 275 | 20 | 105 | 95 | 45 | 15 | 195 | 885 |
| Lane Group Flow (vph) | 0 | 485 | 0 | 143 | 108 | 51 | 17 | 223 | 1033 |
| Turn Type | Perm | NA | Perm | NA | Perm | Prot | NA | Prot | NA |
| Protected Phases | | 8 | | 4 | | 5 | 2 | 1 | 6 |
| Permitted Phases | 8 | | 4 | | 4 | | | | |
| Detector Phase | 8 | 8 | 4 | 4 | 4 | 5 | 2 | 1 | 6 |
| Switch Phase | | | | | | | | | |
| Minimum Initial (s) | 10.0 | 10.0 | 10.0 | 10.0 | 10.0 | 7.0 | 10.0 | 7.0 | 10.0 |
| Minimum Split (s) | 31.6 | 31.6 | 31.6 | 31.6 | 31.6 | 12.0 | 22.8 | 12.0 | 22.8 |
| Total Split (s) | 40.0 | 40.0 | 40.0 | 40.0 | 40.0 | 14.0 | 53.0 | 27.0 | 66.0 |
| Total Split (%) | 33.3% | 33.3% | 33.3% | 33.3% | 33.3% | 11.7% | 44.2% | 22.5% | 55.0% |
| Yellow Time (s) | 4.1 | 4.1 | 4.1 | 4.1 | 4.1 | 4.0 | 4.1 | 4.0 | 4.1 |
| All-Red Time (s) | 2.4 | 2.4 | 2.4 | 2.4 | 2.4 | 1.0 | 1.7 | 1.0 | 1.7 |
| Lost Time Adjust (s) | | 0.0 | | 0.0 | 0.0 | 0.0 | 0.0 | 0.0 | 0.0 |
| Total Lost Time (s) | | 6.5 | | 6.5 | 6.5 | 5.0 | 5.8 | 5.0 | 5.8 |
| Lead/Lag | | | | | | Lead | Lag | Lead | Lag |
| Lead-Lag Optimize? | | | | | | | | | |
| Recall Mode | Ped | Ped | Ped | Ped | Ped | None | C-Min | None | Min |
| Act Effct Green (s) | | 44.7 | | 44.7 | 44.7 | 8.3 | 38.2 | 19.8 | 52.1 |
| Actuated g/C Ratio | | 0.37 | | 0.37 | 0.37 | 0.07 | 0.32 | 0.16 | 0.43 |
| v/c Ratio | | 0.82 | | 0.24 | 0.20 | 0.48 | 0.03 | 0.82 | 0.73 |
| Control Delay | | 47.4 | | 29.1 | 5.5 | 82.7 | 25.9 | 71.9 | 31.6 |
| Queue Delay | | 0.0 | | 0.0 | 0.0 | 0.0 | 0.0 | 0.0 | 0.0 |
| Total Delay | | 47.4 | | 29.1 | 5.5 | 82.7 | 25.9 | 71.9 | 31.6 |
| LOS | | D | | C | A | F | C | E | C |
| Approach Delay | | 47.4 | | 19.0 | | | 68.5 | | 38.7 |
| Approach LOS | | D | | B | | | E | | D |
| Queue Length 50th (m) | | 100.1 | | 22.9 | 0.0 | 12.7 | 2.7 | 50.2 | 109.0 |
| Queue Length 95th (m) | | #180.5 | | 42.8 | 11.3 | m23.7 | m5.5 | #83.8 | 118.6 |
| Internal Link Dist (m) | | 189.8 | | 183.6 | | | 355.1 | | 413.3 |
| Turn Bay Length (m) | | | | | 40.0 | 50.0 | | 90.0 | |
| Base Capacity (vph) | | 593 | | 605 | 551 | 116 | 676 | 302 | 1638 |
| Starvation Cap Reductn | | 0 | | 0 | 0 | 0 | 0 | 0 | 0 |
| Spillback Cap Reductn | | 0 | | 0 | 0 | 0 | 0 | 0 | 0 |
| Storage Cap Reductn | | 0 | | 0 | 0 | 0 | 0 | 0 | 0 |
| Reduced v/c Ratio | | 0.82 | | 0.24 | 0.20 | 0.44 | 0.03 | 0.74 | 0.63 |

Intersection Summary

Cycle Length: 120
 Actuated Cycle Length: 120
 Offset: 48 (40%), Referenced to phase 2:NBT, Start of Green
 Natural Cycle: 80
 Control Type: Actuated-Coordinated
 Maximum v/c Ratio: 0.82
 Intersection Signal Delay: 39.3
 Intersection Capacity Utilization 78.7%
 Analysis Period (min) 15
 # 95th percentile volume exceeds capacity, queue may be longer.
 Queue shown is maximum after two cycles.
 m Volume for 95th percentile queue is metered by upstream signal.

Splits and Phases: 8: Robie & Jubilee/Veterans Memorial

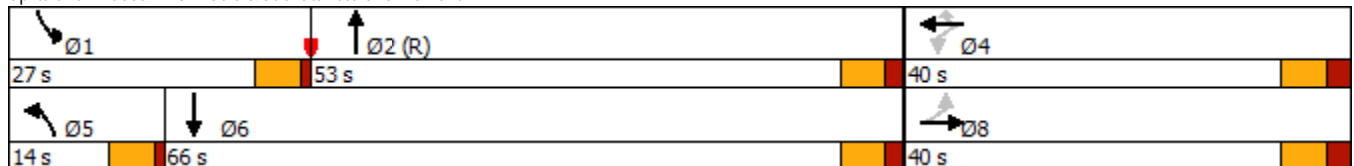

| Lane Group | EBL2 | EBT | WBL | WBT | NBL | NBT | SBU | SBL2 | SBL | SBT |
|------------------------|-------|-------|-------|-------|-------|-------|-------|-------|---------|--------|
| Lane Configurations | | | | | | | | | | |
| Traffic Volume (vph) | 45 | 170 | 45 | 150 | 50 | 11 | 20 | 0 | 204 | 741 |
| Future Volume (vph) | 45 | 170 | 45 | 150 | 50 | 11 | 20 | 0 | 204 | 741 |
| Lane Group Flow (vph) | 0 | 245 | 0 | 353 | 57 | 13 | 0 | 23 | 233 | 903 |
| Turn Type | Perm | NA | Perm | NA | Prot | NA | D.P+P | D.P+P | Prot | NA |
| Protected Phases | | 4 | | 4 | 5 | 2 | 9 | 9 | 1 | 6 |
| Permitted Phases | 4 | | 4 | | | | 2 | 2 | | |
| Detector Phase | 4 | 4 | 4 | 4 | 5 | 2 | 9 | 9 | 1 | 6 |
| Switch Phase | | | | | | | | | | |
| Minimum Initial (s) | 10.0 | 10.0 | 10.0 | 10.0 | 8.0 | 10.0 | 8.0 | 8.0 | 8.0 | 10.0 |
| Minimum Split (s) | 33.5 | 33.5 | 33.5 | 33.5 | 13.0 | 34.5 | 13.0 | 13.0 | 13.0 | 34.5 |
| Total Split (s) | 45.0 | 45.0 | 45.0 | 45.0 | 17.0 | 45.0 | 13.0 | 13.0 | 17.0 | 58.0 |
| Total Split (%) | 37.5% | 37.5% | 37.5% | 37.5% | 14.2% | 37.5% | 10.8% | 10.8% | 14.2% | 48.3% |
| Yellow Time (s) | 4.1 | 4.1 | 4.1 | 4.1 | 4.0 | 4.1 | 3.0 | 3.0 | 4.0 | 4.1 |
| All-Red Time (s) | 2.4 | 2.4 | 2.4 | 2.4 | 1.0 | 2.4 | 0.0 | 0.0 | 1.0 | 2.4 |
| Lost Time Adjust (s) | | 0.0 | | 0.0 | 0.0 | 0.0 | | 0.0 | 0.0 | 0.0 |
| Total Lost Time (s) | | 6.5 | | 6.5 | 5.0 | 6.5 | | 3.0 | 5.0 | 6.5 |
| Lead/Lag | | | | | Lead | | Lag | Lag | Lead | Lag |
| Lead-Lag Optimize? | | | | | | | | | | |
| Recall Mode | None | None | None | None | None | C-Max | None | None | None | C-Max |
| Act Effct Green (s) | | 26.8 | | 26.8 | 9.8 | 44.9 | | 53.2 | 23.7 | 68.0 |
| Actuated g/C Ratio | | 0.22 | | 0.22 | 0.08 | 0.37 | | 0.44 | 0.20 | 0.57 |
| v/c Ratio | | 0.84 | | 0.60 | 0.40 | 0.02 | | 0.04 | 0.69 | 0.95 |
| Control Delay | | 68.2 | | 32.2 | 60.3 | 26.6 | | 5.5 | 76.1 | 32.8 |
| Queue Delay | | 0.0 | | 0.0 | 0.0 | 0.0 | | 0.0 | 0.0 | 0.0 |
| Total Delay | | 68.2 | | 32.2 | 60.3 | 26.6 | | 5.5 | 76.1 | 32.8 |
| LOS | | E | | C | E | C | | A | E | C |
| Approach Delay | | 68.2 | | 32.2 | | 54.0 | | | | 41.0 |
| Approach LOS | | E | | C | | D | | | | D |
| Queue Length 50th (m) | | 55.3 | | 27.5 | 13.0 | 2.0 | | 0.6 | 56.6 | 85.7 |
| Queue Length 95th (m) | | 76.9 | | 38.5 | 25.8 | 6.5 | | m1.3 | m#115.8 | #343.8 |
| Internal Link Dist (m) | | 121.4 | | 124.9 | | 240.3 | | | | 355.1 |
| Turn Bay Length (m) | | | | | 60.0 | | | | | |
| Base Capacity (vph) | | 418 | | 797 | 176 | 582 | | 656 | 339 | 952 |
| Starvation Cap Reductn | | 0 | | 0 | 0 | 0 | | 0 | 0 | 0 |
| Spillback Cap Reductn | | 0 | | 0 | 0 | 0 | | 0 | 0 | 0 |
| Storage Cap Reductn | | 0 | | 0 | 0 | 0 | | 0 | 0 | 0 |
| Reduced v/c Ratio | | 0.59 | | 0.44 | 0.32 | 0.02 | | 0.04 | 0.69 | 0.95 |

Intersection Summary

Cycle Length: 120
 Actuated Cycle Length: 120
 Offset: 82 (68%), Referenced to phase 2:NBSB and 6:SBT, Start of Green
 Natural Cycle: 115
 Control Type: Actuated-Coordinated
 Maximum v/c Ratio: 0.95
 Intersection Signal Delay: 43.4
 Intersection Capacity Utilization 105.6%
 Analysis Period (min) 15
 # 95th percentile volume exceeds capacity, queue may be longer.
 Queue shown is maximum after two cycles.
 m Volume for 95th percentile queue is metered by upstream signal.

Splits and Phases: 9: Robie & Coburg/Spring Garden

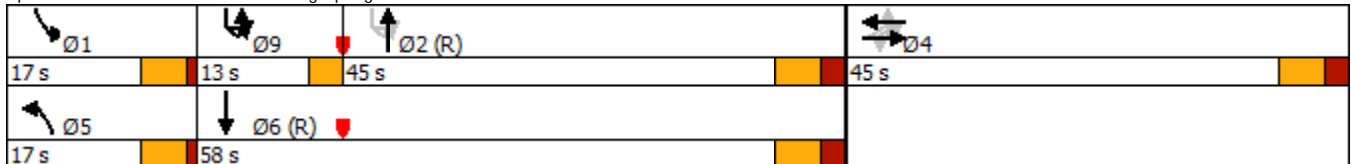

| Lane Group | EBL | EBT | WBL | WBT | WBR | NBL | NBT | SBL | SBT |
|------------------------|-------|-------|-------|-------|-------|-------|-------|--------|-------|
| Lane Configurations | | | | | | | | | |
| Traffic Volume (vph) | 30 | 145 | 30 | 85 | 95 | 10 | 9 | 345 | 455 |
| Future Volume (vph) | 30 | 145 | 30 | 85 | 95 | 10 | 9 | 345 | 455 |
| Lane Group Flow (vph) | 34 | 194 | 34 | 97 | 108 | 11 | 10 | 394 | 576 |
| Turn Type | Perm | NA | Perm | NA | pm+ov | pm+pt | NA | Prot | NA |
| Protected Phases | | 8 | | 4 | 5 | 1 | 6 | 5 | 2 |
| Permitted Phases | 8 | | 4 | | 4 | 6 | | | |
| Detector Phase | 8 | 8 | 4 | 4 | 5 | 1 | 6 | 5 | 2 |
| Switch Phase | | | | | | | | | |
| Minimum Initial (s) | 10.0 | 10.0 | 10.0 | 10.0 | 8.0 | 8.0 | 10.0 | 8.0 | 10.0 |
| Minimum Split (s) | 32.5 | 32.5 | 32.5 | 32.5 | 13.0 | 13.0 | 43.3 | 13.0 | 43.3 |
| Total Split (s) | 33.0 | 33.0 | 33.0 | 33.0 | 38.0 | 13.0 | 44.0 | 38.0 | 69.0 |
| Total Split (%) | 28.7% | 28.7% | 28.7% | 28.7% | 33.0% | 11.3% | 38.3% | 33.0% | 60.0% |
| Yellow Time (s) | 4.1 | 4.1 | 4.1 | 4.1 | 4.0 | 4.0 | 4.1 | 4.0 | 4.1 |
| All-Red Time (s) | 2.4 | 2.4 | 2.4 | 2.4 | 1.0 | 1.0 | 3.2 | 1.0 | 3.2 |
| Lost Time Adjust (s) | 0.0 | 0.0 | 0.0 | 0.0 | 0.0 | 0.0 | 0.0 | 0.0 | 0.0 |
| Total Lost Time (s) | 6.5 | 6.5 | 6.5 | 6.5 | 5.0 | 5.0 | 7.3 | 5.0 | 7.3 |
| Lead/Lag | | | | | | Lead | | | Lag |
| Lead-Lag Optimize? | | | | | | | | | |
| Recall Mode | Ped | Ped | Ped | Ped | None | None | C-Max | None | C-Max |
| Act Effct Green (s) | 26.0 | 26.0 | 26.0 | 26.0 | 57.6 | 50.4 | 40.1 | 30.0 | 72.6 |
| Actuated g/C Ratio | 0.23 | 0.23 | 0.23 | 0.23 | 0.50 | 0.44 | 0.35 | 0.26 | 0.63 |
| v/c Ratio | 0.27 | 0.54 | 0.18 | 0.26 | 0.20 | 0.03 | 0.02 | 0.88 | 0.62 |
| Control Delay | 43.2 | 44.2 | 39.1 | 38.9 | 3.3 | 11.4 | 32.6 | 61.9 | 17.4 |
| Queue Delay | 0.0 | 0.0 | 0.0 | 0.0 | 0.0 | 0.0 | 0.0 | 0.0 | 0.0 |
| Total Delay | 43.2 | 44.2 | 39.1 | 38.9 | 3.3 | 11.4 | 32.6 | 61.9 | 17.4 |
| LOS | D | D | D | D | A | B | C | E | B |
| Approach Delay | | 44.0 | | 22.9 | | | 21.5 | | 35.5 |
| Approach LOS | | D | | C | | | C | | D |
| Queue Length 50th (m) | 6.3 | 37.3 | 6.2 | 18.1 | 0.0 | 1.0 | 1.8 | 83.1 | 66.6 |
| Queue Length 95th (m) | 16.1 | 60.7 | 15.3 | 33.0 | 7.3 | m2.5 | m5.7 | #126.5 | 136.9 |
| Internal Link Dist (m) | | 178.0 | | 171.4 | | | 167.5 | | 240.3 |
| Turn Bay Length (m) | 15.0 | | 15.0 | | 60.0 | 60.0 | | 60.0 | |
| Base Capacity (vph) | 130 | 366 | 189 | 374 | 570 | 396 | 521 | 495 | 933 |
| Starvation Cap Reductn | 0 | 0 | 0 | 0 | 0 | 0 | 0 | 0 | 0 |
| Spillback Cap Reductn | 0 | 0 | 0 | 0 | 0 | 0 | 0 | 0 | 0 |
| Storage Cap Reductn | 0 | 0 | 0 | 0 | 0 | 0 | 0 | 0 | 0 |
| Reduced v/c Ratio | 0.26 | 0.53 | 0.18 | 0.26 | 0.19 | 0.03 | 0.02 | 0.80 | 0.62 |

Intersection Summary

Cycle Length: 115
 Actuated Cycle Length: 115
 Offset: 108 (94%), Referenced to phase 2:SBT and 6:NBTL, Start of Green
 Natural Cycle: 100
 Control Type: Actuated-Coordinated
 Maximum v/c Ratio: 0.88
 Intersection Signal Delay: 34.5
 Intersection Capacity Utilization 70.2%
 Analysis Period (min) 15
 # 95th percentile volume exceeds capacity, queue may be longer.
 Queue shown is maximum after two cycles.
 m Volume for 95th percentile queue is metered by upstream signal.

Splits and Phases: 10: Robie & University

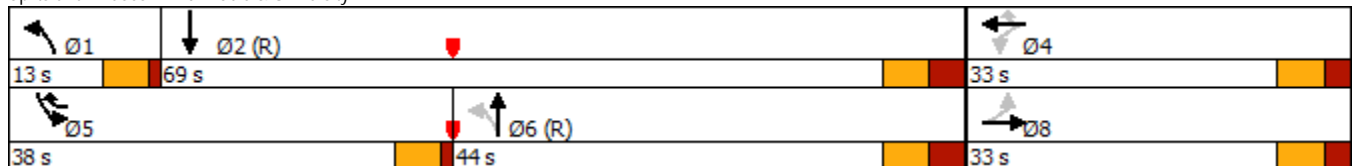

| Lane Group | EBL | EBT | WBL | WBT | WBR2 | NBL2 | NBL | NBT | SBL | SBT |
|------------------------|-------|-------|-------|-------|-------|-------|-------|-------|-------|-------|
| Lane Configurations | | | | | | | | | | |
| Traffic Volume (vph) | 50 | 290 | 10 | 135 | 105 | 22 | 3 | 4 | 171 | 275 |
| Future Volume (vph) | 50 | 290 | 10 | 135 | 105 | 22 | 3 | 4 | 171 | 275 |
| Lane Group Flow (vph) | 0 | 422 | 0 | 165 | 120 | 17 | 0 | 16 | 195 | 357 |
| Turn Type | Perm | NA | Perm | NA | Perm | Prot | Perm | NA | Prot | NA |
| Protected Phases | | 4 | | 4 | | 5 | | 2 | 1 | 6 |
| Permitted Phases | 4 | | 4 | | 4 | | 2 | | | |
| Detector Phase | 4 | 4 | 4 | 4 | 4 | 5 | 2 | 2 | 1 | 6 |
| Switch Phase | | | | | | | | | | |
| Minimum Initial (s) | 10.0 | 10.0 | 10.0 | 10.0 | 10.0 | 7.3 | 10.0 | 10.0 | 8.0 | 10.0 |
| Minimum Split (s) | 47.8 | 47.8 | 47.8 | 47.8 | 47.8 | 13.0 | 24.7 | 24.7 | 13.0 | 24.7 |
| Total Split (s) | 51.0 | 51.0 | 51.0 | 51.0 | 51.0 | 13.0 | 45.0 | 45.0 | 19.0 | 51.0 |
| Total Split (%) | 44.3% | 44.3% | 44.3% | 44.3% | 44.3% | 11.3% | 39.1% | 39.1% | 16.5% | 44.3% |
| Yellow Time (s) | 4.1 | 4.1 | 4.1 | 4.1 | 4.1 | 4.1 | 4.1 | 4.1 | 4.0 | 4.1 |
| All-Red Time (s) | 2.7 | 2.7 | 2.7 | 2.7 | 2.7 | 1.6 | 1.6 | 1.6 | 1.0 | 1.6 |
| Lost Time Adjust (s) | | 0.0 | | 0.0 | 0.0 | 0.0 | | 0.0 | 0.0 | 0.0 |
| Total Lost Time (s) | | 6.8 | | 6.8 | 6.8 | 5.7 | | 5.7 | 5.0 | 5.7 |
| Lead/Lag | | | | | | Lead | Lag | Lag | Lead | Lag |
| Lead-Lag Optimize? | | | | | | | | | | |
| Recall Mode | Ped | Ped | Ped | Ped | Ped | Min | C-Min | C-Min | None | C-Min |
| Act Effct Green (s) | | 42.5 | | 42.5 | 42.5 | 7.4 | | 34.9 | 20.1 | 47.0 |
| Actuated g/C Ratio | | 0.37 | | 0.37 | 0.37 | 0.06 | | 0.30 | 0.17 | 0.41 |
| v/c Ratio | | 0.78 | | 0.26 | 0.20 | 0.18 | | 0.04 | 0.70 | 0.60 |
| Control Delay | | 42.8 | | 26.2 | 4.4 | 55.6 | | 28.9 | 62.9 | 21.2 |
| Queue Delay | | 0.0 | | 0.0 | 0.0 | 0.0 | | 0.0 | 0.0 | 0.0 |
| Total Delay | | 42.8 | | 26.2 | 4.4 | 55.6 | | 28.9 | 62.9 | 21.2 |
| LOS | | D | | C | A | E | | C | E | C |
| Approach Delay | | 42.8 | | 17.0 | | | | 42.7 | | 35.9 |
| Approach LOS | | D | | B | | | | D | | D |
| Queue Length 50th (m) | | 84.2 | | 26.2 | 0.0 | 3.8 | | 2.7 | 33.9 | 51.1 |
| Queue Length 95th (m) | | 117.8 | | 40.3 | 10.2 | 11.6 | | 7.8 | #90.2 | 69.5 |
| Internal Link Dist (m) | | 115.5 | | 183.6 | | | | 422.3 | | 167.5 |
| Turn Bay Length (m) | | | | | 50.0 | | | | 60.0 | |
| Base Capacity (vph) | | 568 | | 669 | 613 | 96 | | 404 | 280 | 600 |
| Starvation Cap Reductn | | 0 | | 0 | 0 | 0 | | 0 | 0 | 0 |
| Spillback Cap Reductn | | 0 | | 0 | 0 | 0 | | 0 | 0 | 0 |
| Storage Cap Reductn | | 0 | | 0 | 0 | 0 | | 0 | 0 | 0 |
| Reduced v/c Ratio | | 0.74 | | 0.25 | 0.20 | 0.18 | | 0.04 | 0.70 | 0.59 |

Intersection Summary

Cycle Length: 115
 Actuated Cycle Length: 115
 Offset: 0 (0%), Referenced to phase 2:NBT and 6:SBT, Start of Green
 Natural Cycle: 90
 Control Type: Actuated-Coordinated
 Maximum v/c Ratio: 0.78
 Intersection Signal Delay: 34.1
 Intersection Capacity Utilization 100.3%
 Analysis Period (min) 15
 # 95th percentile volume exceeds capacity, queue may be longer.
 Queue shown is maximum after two cycles.

Splits and Phases: 11: Robie & South

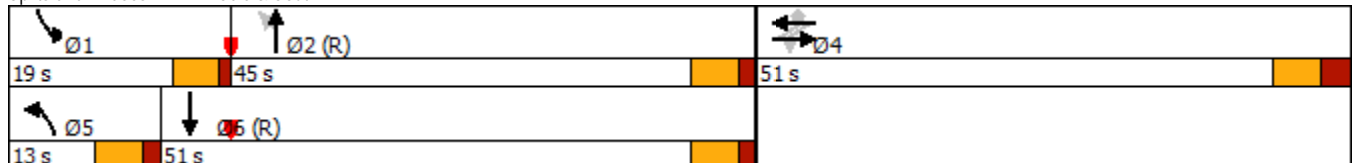

| Lane Group | EBL | EBT | WBL | WBT | WBR | NBL | NBT | SBL | SBT | SBR |
|------------------------|-------|-------|-------|-------|-------|-------|-------|-------|-------|-------|
| Lane Configurations | | | | | | | | | | |
| Traffic Volume (vph) | 20 | 260 | 65 | 185 | 170 | 10 | 40 | 210 | 105 | 20 |
| Future Volume (vph) | 20 | 260 | 65 | 185 | 170 | 10 | 40 | 210 | 105 | 20 |
| Lane Group Flow (vph) | 0 | 371 | 0 | 285 | 194 | 0 | 108 | 240 | 120 | 23 |
| Turn Type | Perm | NA | Perm | NA | Perm | Perm | NA | pm+pt | NA | Perm |
| Protected Phases | | 8 | | 4 | 4 | | 6 | 5 | 2 | |
| Permitted Phases | 8 | | 4 | | 4 | 6 | | 2 | | 2 |
| Detector Phase | 8 | 8 | 4 | 4 | 4 | 6 | 6 | 5 | 2 | 2 |
| Switch Phase | | | | | | | | | | |
| Minimum Initial (s) | 10.0 | 10.0 | 10.0 | 10.0 | 10.0 | 10.0 | 10.0 | 8.0 | 10.0 | 10.0 |
| Minimum Split (s) | 31.7 | 31.7 | 31.7 | 31.7 | 31.7 | 23.1 | 23.1 | 13.0 | 23.1 | 23.1 |
| Total Split (s) | 40.0 | 40.0 | 40.0 | 40.0 | 40.0 | 36.0 | 36.0 | 14.0 | 50.0 | 50.0 |
| Total Split (%) | 44.4% | 44.4% | 44.4% | 44.4% | 44.4% | 40.0% | 40.0% | 15.6% | 55.6% | 55.6% |
| Yellow Time (s) | 4.1 | 4.1 | 4.1 | 4.1 | 4.1 | 4.1 | 4.1 | 3.0 | 4.1 | 4.1 |
| All-Red Time (s) | 2.6 | 2.6 | 2.6 | 2.6 | 2.6 | 2.0 | 2.0 | 0.0 | 2.0 | 2.0 |
| Lost Time Adjust (s) | | 0.0 | | 0.0 | 0.0 | | 0.0 | 0.0 | 0.0 | 0.0 |
| Total Lost Time (s) | | 6.7 | | 6.7 | 6.7 | | 6.1 | 3.0 | 6.1 | 6.1 |
| Lead/Lag | | | | | | Lag | Lag | Lead | | |
| Lead-Lag Optimize? | | | | | | | | | | |
| Recall Mode | Ped | Ped | Ped | Ped | Ped | C-Min | C-Min | None | C-Min | C-Min |
| Act Effct Green (s) | | 27.8 | | 27.8 | 27.8 | | 34.1 | 52.5 | 49.4 | 49.4 |
| Actuated g/C Ratio | | 0.31 | | 0.31 | 0.31 | | 0.38 | 0.58 | 0.55 | 0.55 |
| v/c Ratio | | 0.70 | | 0.78 | 0.34 | | 0.20 | 0.35 | 0.14 | 0.04 |
| Control Delay | | 33.8 | | 43.3 | 4.8 | | 14.3 | 11.6 | 11.5 | 1.7 |
| Queue Delay | | 0.0 | | 0.0 | 0.0 | | 0.0 | 0.0 | 0.0 | 0.0 |
| Total Delay | | 33.8 | | 43.3 | 4.8 | | 14.3 | 11.6 | 11.5 | 1.7 |
| LOS | | C | | D | A | | B | B | B | A |
| Approach Delay | | 33.8 | | 27.7 | | | 14.3 | | 11.0 | |
| Approach LOS | | C | | C | | | B | | B | |
| Queue Length 50th (m) | | 57.3 | | 46.6 | 0.0 | | 5.8 | 17.1 | 8.8 | 0.0 |
| Queue Length 95th (m) | | 75.5 | | 66.8 | 12.6 | | 21.3 | 37.2 | 21.3 | 1.9 |
| Internal Link Dist (m) | | 113.9 | | 142.4 | | | 118.8 | | 422.3 | |
| Turn Bay Length (m) | | | | | 50.0 | | | 60.0 | | 20.0 |
| Base Capacity (vph) | | 640 | | 442 | 651 | | 560 | 684 | 855 | 645 |
| Starvation Cap Reductn | | 0 | | 0 | 0 | | 0 | 0 | 0 | 0 |
| Spillback Cap Reductn | | 0 | | 0 | 0 | | 0 | 0 | 0 | 0 |
| Storage Cap Reductn | | 0 | | 0 | 0 | | 0 | 0 | 0 | 0 |
| Reduced v/c Ratio | | 0.58 | | 0.64 | 0.30 | | 0.19 | 0.35 | 0.14 | 0.04 |

Intersection Summary

Cycle Length: 90
 Actuated Cycle Length: 90
 Offset: 0 (0%), Referenced to phase 2:SBTL and 6:NBTL, Start of Green
 Natural Cycle: 70
 Control Type: Actuated-Coordinated
 Maximum v/c Ratio: 0.78
 Intersection Signal Delay: 23.5
 Intersection Capacity Utilization 72.1%
 Analysis Period (min) 15

Intersection LOS: C
 ICU Level of Service C

Splits and Phases: 12: Robie & Inglis

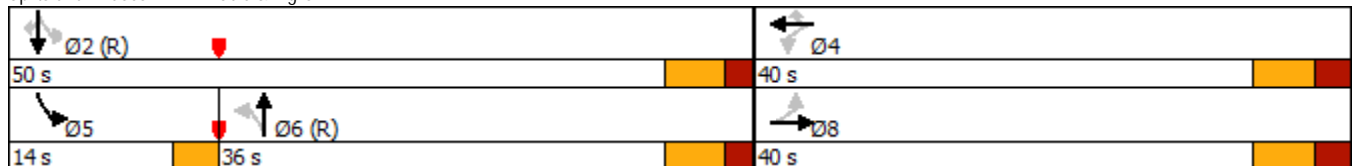

| Lane Group | EBL | EBT | WBL | WBT | WBR | NBL | NBT | SBL | SBT |
|------------------------|-------|-------|-------|-------|-------|-------|-------|-------|-------|
| Lane Configurations | | | | | | | | | |
| Traffic Volume (vph) | 150 | 290 | 20 | 195 | 45 | 30 | 456 | 40 | 12 |
| Future Volume (vph) | 150 | 290 | 20 | 195 | 45 | 30 | 456 | 40 | 12 |
| Lane Group Flow (vph) | 171 | 388 | 0 | 246 | 51 | 34 | 537 | 46 | 14 |
| Turn Type | pm+pt | NA | Perm | NA | Perm | Prot | NA | Prot | NA |
| Protected Phases | 3 | 8 | | 4 | | 1 | 2 | 1 | 2 |
| Permitted Phases | 8 | | 4 | | 4 | | | | |
| Detector Phase | 3 | 8 | 4 | 4 | 4 | 1 | 2 | 1 | 2 |
| Switch Phase | | | | | | | | | |
| Minimum Initial (s) | 7.0 | 10.0 | 10.0 | 10.0 | 10.0 | 8.0 | 10.0 | 8.0 | 10.0 |
| Minimum Split (s) | 11.0 | 50.0 | 37.0 | 37.0 | 37.0 | 13.0 | 40.0 | 13.0 | 40.0 |
| Total Split (s) | 13.0 | 51.0 | 38.0 | 38.0 | 38.0 | 13.0 | 56.0 | 13.0 | 56.0 |
| Total Split (%) | 10.8% | 42.5% | 31.7% | 31.7% | 31.7% | 10.8% | 46.7% | 10.8% | 46.7% |
| Yellow Time (s) | 4.0 | 4.1 | 4.1 | 4.1 | 4.1 | 4.0 | 4.1 | 4.0 | 4.1 |
| All-Red Time (s) | 0.0 | 2.1 | 2.1 | 2.1 | 2.1 | 1.0 | 1.7 | 1.0 | 1.7 |
| Lost Time Adjust (s) | 0.0 | 0.0 | | 0.0 | 0.0 | 0.0 | 0.0 | 0.0 | 0.0 |
| Total Lost Time (s) | 4.0 | 6.2 | | 6.2 | 6.2 | 5.0 | 5.8 | 5.0 | 5.8 |
| Lead/Lag | Lead | | Lag | Lag | Lag | Lead | Lag | Lead | Lag |
| Lead-Lag Optimize? | | | | | | | | | |
| Recall Mode | None | None | None | None | None | None | C-Min | None | C-Min |
| Act Effct Green (s) | 38.7 | 36.5 | | 20.3 | 20.3 | 9.1 | 60.0 | 9.1 | 60.0 |
| Actuated g/C Ratio | 0.32 | 0.30 | | 0.17 | 0.17 | 0.08 | 0.50 | 0.08 | 0.50 |
| v/c Ratio | 0.62 | 0.72 | | 0.72 | 0.16 | 0.25 | 0.62 | 0.35 | 0.02 |
| Control Delay | 40.5 | 44.0 | | 58.8 | 1.0 | 56.5 | 28.3 | 72.6 | 9.8 |
| Queue Delay | 0.0 | 0.0 | | 0.0 | 0.0 | 0.0 | 0.0 | 0.0 | 0.0 |
| Total Delay | 40.5 | 44.0 | | 58.8 | 1.0 | 56.5 | 28.3 | 72.6 | 9.8 |
| LOS | D | D | | E | A | E | C | E | A |
| Approach Delay | | 42.9 | | 48.9 | | | 30.0 | | 58.0 |
| Approach LOS | | D | | D | | | C | | E |
| Queue Length 50th (m) | 29.6 | 78.3 | | 55.8 | 0.0 | 7.7 | 94.0 | 11.5 | 1.1 |
| Queue Length 95th (m) | 45.4 | 107.8 | | 75.9 | 0.0 | 17.7 | 146.7 | m13.1 | m0.8 |
| Internal Link Dist (m) | | 253.6 | | 204.8 | | | 402.8 | | 360.9 |
| Turn Bay Length (m) | 80.0 | | | | 50.0 | 25.0 | | 180.0 | |
| Base Capacity (vph) | 277 | 660 | | 534 | 447 | 134 | 871 | 131 | 911 |
| Starvation Cap Reductn | 0 | 0 | | 0 | 0 | 0 | 0 | 0 | 0 |
| Spillback Cap Reductn | 0 | 0 | | 0 | 0 | 0 | 0 | 0 | 0 |
| Storage Cap Reductn | 0 | 0 | | 0 | 0 | 0 | 0 | 0 | 0 |
| Reduced v/c Ratio | 0.62 | 0.59 | | 0.46 | 0.11 | 0.25 | 0.62 | 0.35 | 0.02 |

Intersection Summary

Cycle Length: 120
 Actuated Cycle Length: 120
 Offset: 78 (65%), Referenced to phase 2:NBSB and 6:, Start of Green
 Natural Cycle: 105
 Control Type: Actuated-Coordinated
 Maximum v/c Ratio: 0.72
 Intersection Signal Delay: 39.7
 Intersection Capacity Utilization 109.4%
 Analysis Period (min) 15
 m Volume for 95th percentile queue is metered by upstream signal.

Intersection LOS: D
 ICU Level of Service H

Splits and Phases: 4: Robie & Almon

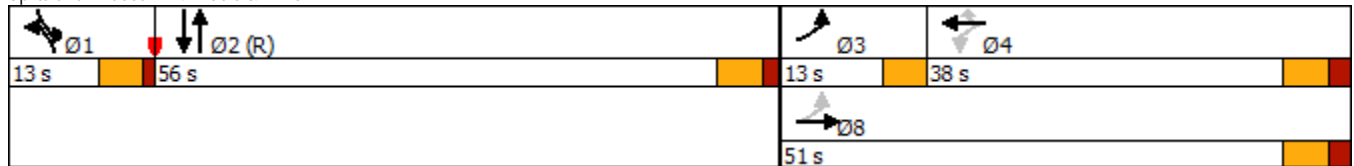

| Lane Group | EBT | WBT | NBT | NBR | SBT |
|------------------------|-------|-------|-------|-------|-------|
| Lane Configurations | | | | | |
| Traffic Volume (vph) | 375 | 420 | 461 | 110 | 12 |
| Future Volume (vph) | 375 | 420 | 461 | 110 | 12 |
| Lane Group Flow (vph) | 457 | 490 | 526 | 126 | 14 |
| Turn Type | NA | NA | NA | Perm | NA |
| Protected Phases | 8 | 4 | 2 | | 2 |
| Permitted Phases | | | | 2 | |
| Detector Phase | 8 | 4 | 2 | 2 | 2 |
| Switch Phase | | | | | |
| Minimum Initial (s) | 10.0 | 10.0 | 10.0 | 10.0 | 10.0 |
| Minimum Split (s) | 23.7 | 23.7 | 50.0 | 50.0 | 50.0 |
| Total Split (s) | 40.0 | 40.0 | 50.0 | 50.0 | 50.0 |
| Total Split (%) | 44.4% | 44.4% | 55.6% | 55.6% | 55.6% |
| Yellow Time (s) | 4.1 | 4.1 | 4.1 | 4.1 | 4.1 |
| All-Red Time (s) | 1.6 | 1.6 | 1.5 | 1.5 | 1.5 |
| Lost Time Adjust (s) | 0.0 | 0.0 | 0.0 | 0.0 | 0.0 |
| Total Lost Time (s) | 5.7 | 5.7 | 5.6 | 5.6 | 5.6 |
| Lead/Lag | | | | | |
| Lead-Lag Optimize? | | | | | |
| Recall Mode | Ped | Ped | C-Min | C-Min | C-Min |
| Act Effct Green (s) | 28.8 | 28.8 | 49.9 | 49.9 | 49.9 |
| Actuated g/C Ratio | 0.32 | 0.32 | 0.55 | 0.55 | 0.55 |
| v/c Ratio | 0.81 | 0.82 | 0.55 | 0.29 | 0.01 |
| Control Delay | 38.9 | 39.9 | 16.9 | 4.5 | 11.4 |
| Queue Delay | 0.0 | 0.0 | 0.0 | 0.0 | 0.0 |
| Total Delay | 38.9 | 39.9 | 16.9 | 4.5 | 11.4 |
| LOS | D | D | B | A | B |
| Approach Delay | 38.9 | 39.9 | 14.5 | | 11.4 |
| Approach LOS | D | D | B | | B |
| Queue Length 50th (m) | 70.0 | 76.1 | 55.9 | 0.0 | 1.1 |
| Queue Length 95th (m) | 95.6 | 102.3 | 97.7 | 9.5 | 4.2 |
| Internal Link Dist (m) | 171.5 | 198.8 | 446.6 | | 402.8 |
| Turn Bay Length (m) | | | | 50.0 | |
| Base Capacity (vph) | 677 | 711 | 968 | 430 | 993 |
| Starvation Cap Reductn | 0 | 0 | 0 | 0 | 0 |
| Spillback Cap Reductn | 0 | 0 | 0 | 0 | 0 |
| Storage Cap Reductn | 0 | 0 | 0 | 0 | 0 |
| Reduced v/c Ratio | 0.68 | 0.69 | 0.54 | 0.29 | 0.01 |

Intersection Summary

Cycle Length: 90
 Actuated Cycle Length: 90
 Offset: 0 (0%), Referenced to phase 2:NBSB, Start of Green
 Natural Cycle: 80
 Control Type: Actuated-Coordinated
 Maximum v/c Ratio: 0.82
 Intersection Signal Delay: 29.1
 Intersection Capacity Utilization 69.6%
 Analysis Period (min) 15

Intersection LOS: C
 ICU Level of Service C

Splits and Phases: 5: Robie & North

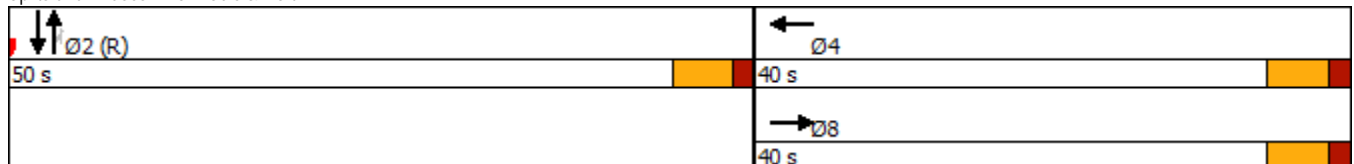

| Lane Group | EBL | EBT | WBL | WBT | WBR | NBL | NBT | SBL | SBT |
|------------------------|-------|--------|-------|-------|-------|-------|-------|-------|-------|
| Lane Configurations | | | | | | | | | |
| Traffic Volume (vph) | 10 | 410 | 40 | 160 | 40 | 44 | 461 | 75 | 11 |
| Future Volume (vph) | 10 | 410 | 40 | 160 | 40 | 44 | 461 | 75 | 11 |
| Lane Group Flow (vph) | 11 | 571 | 46 | 183 | 46 | 50 | 549 | 86 | 13 |
| Turn Type | Perm | NA | Perm | NA | Perm | Prot | NA | Prot | NA |
| Protected Phases | | 8 | | 4 | | 5 | 2 | 1 | 6 |
| Permitted Phases | 8 | | 4 | | 4 | | | | |
| Detector Phase | 8 | 8 | 4 | 4 | 4 | 5 | 2 | 1 | 6 |
| Switch Phase | | | | | | | | | |
| Minimum Initial (s) | 10.0 | 10.0 | 10.0 | 10.0 | 10.0 | 8.0 | 10.0 | 8.0 | 8.0 |
| Minimum Split (s) | 39.1 | 39.1 | 39.1 | 39.1 | 39.1 | 13.0 | 37.9 | 13.0 | 24.0 |
| Total Split (s) | 49.0 | 49.0 | 49.0 | 49.0 | 49.0 | 15.0 | 56.0 | 15.0 | 56.0 |
| Total Split (%) | 40.8% | 40.8% | 40.8% | 40.8% | 40.8% | 12.5% | 46.7% | 12.5% | 46.7% |
| Yellow Time (s) | 4.1 | 4.1 | 4.1 | 4.1 | 4.1 | 4.0 | 4.1 | 4.0 | 4.0 |
| All-Red Time (s) | 3.0 | 3.0 | 3.0 | 3.0 | 3.0 | 1.0 | 2.0 | 1.0 | 2.0 |
| Lost Time Adjust (s) | 0.0 | 0.0 | 0.0 | 0.0 | 0.0 | 0.0 | 0.0 | 0.0 | 0.0 |
| Total Lost Time (s) | 7.1 | 7.1 | 7.1 | 7.1 | 7.1 | 5.0 | 6.1 | 5.0 | 6.0 |
| Lead/Lag | | | | | | | Lag | Lead | |
| Lead-Lag Optimize? | | | | | | | | | |
| Recall Mode | Ped | Ped | Ped | Ped | Ped | None | C-Min | None | C-Min |
| Act Effct Green (s) | 49.8 | 49.8 | 49.8 | 49.8 | 49.8 | 9.0 | 42.5 | 9.5 | 45.7 |
| Actuated g/C Ratio | 0.42 | 0.42 | 0.42 | 0.42 | 0.42 | 0.08 | 0.35 | 0.08 | 0.38 |
| v/c Ratio | 0.03 | 0.97 | 0.29 | 0.24 | 0.08 | 0.40 | 0.86 | 0.63 | 0.02 |
| Control Delay | 25.0 | 65.8 | 33.3 | 25.8 | 2.5 | 62.5 | 49.3 | 73.7 | 22.1 |
| Queue Delay | 0.0 | 0.0 | 0.0 | 0.0 | 0.0 | 0.0 | 0.0 | 0.0 | 0.0 |
| Total Delay | 25.0 | 65.8 | 33.3 | 25.8 | 2.5 | 62.5 | 49.3 | 73.7 | 22.1 |
| LOS | C | E | C | C | A | E | D | E | C |
| Approach Delay | | 65.0 | | 23.1 | | | 50.4 | | 67.0 |
| Approach LOS | | E | | C | | | D | | E |
| Queue Length 50th (m) | 1.5 | 131.6 | 7.2 | 28.1 | 0.0 | 11.5 | 117.5 | 19.9 | 1.9 |
| Queue Length 95th (m) | 5.9 | #224.5 | 19.5 | 49.3 | 3.4 | 24.1 | 148.5 | #39.6 | 5.7 |
| Internal Link Dist (m) | | 72.7 | | 213.1 | | | 210.2 | | 446.6 |
| Turn Bay Length (m) | 50.0 | | | | 50.0 | 40.0 | | 40.0 | |
| Base Capacity (vph) | 354 | 591 | 159 | 756 | 586 | 139 | 751 | 144 | 760 |
| Starvation Cap Reductn | 0 | 0 | 0 | 0 | 0 | 0 | 0 | 0 | 0 |
| Spillback Cap Reductn | 0 | 0 | 0 | 0 | 0 | 0 | 0 | 0 | 0 |
| Storage Cap Reductn | 0 | 0 | 0 | 0 | 0 | 0 | 0 | 0 | 0 |
| Reduced v/c Ratio | 0.03 | 0.97 | 0.29 | 0.24 | 0.08 | 0.36 | 0.73 | 0.60 | 0.02 |

Intersection Summary

Cycle Length: 120
 Actuated Cycle Length: 120
 Offset: 0 (0%), Referenced to phase 2:NBT and 6:SBT, Start of Green
 Natural Cycle: 90
 Control Type: Actuated-Coordinated
 Maximum v/c Ratio: 0.97
 Intersection Signal Delay: 52.1
 Intersection Capacity Utilization 83.7%
 Analysis Period (min) 15
 # 95th percentile volume exceeds capacity, queue may be longer.
 Queue shown is maximum after two cycles.

Intersection LOS: D
 ICU Level of Service E

Splits and Phases: 6: Robie & Cunard

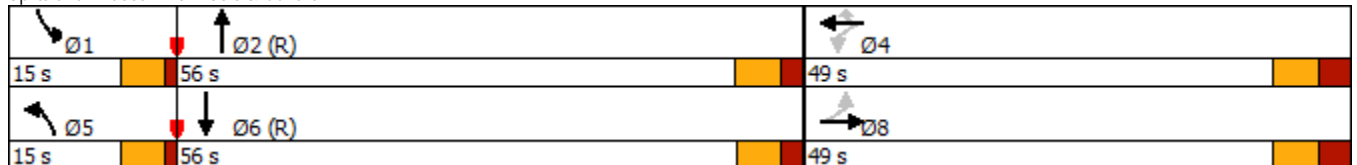

| | | | | | | | | | | Ø9 |
|------------------------|--------|-------|--------|-------|--------|-------|--------|-------|-------|------|
| Lane Group | EBT | EBR | EBR2 | WBT | NBL | NBT | SBL | SBT | NWL | Ø9 |
| Lane Configurations | | | | | | | | | | |
| Traffic Volume (vph) | 410 | 470 | 400 | 205 | 150 | 390 | 238 | 20 | 245 | |
| Future Volume (vph) | 410 | 470 | 400 | 205 | 150 | 390 | 238 | 20 | 245 | |
| Lane Group Flow (vph) | 468 | 536 | 457 | 268 | 171 | 485 | 350 | 23 | 406 | |
| Turn Type | NA | pt+ov | Perm | NA | Prot | NA | Prot | NA | Prot | |
| Protected Phases | 7 | 7 8 | | 7 | 1 | 6 | 5 | 2 | 8 | 9 |
| Permitted Phases | | | 7 | | | | | | | |
| Minimum Split (s) | 37.0 | | 37.0 | 37.0 | 14.0 | 36.0 | 14.0 | 49.0 | 36.0 | 13.0 |
| Total Split (s) | 44.0 | | 44.0 | 44.0 | 18.0 | 37.0 | 33.0 | 37.0 | 36.0 | 15.0 |
| Total Split (%) | 29.3% | | 29.3% | 29.3% | 12.0% | 24.7% | 22.0% | 24.7% | 24.0% | 10% |
| Yellow Time (s) | 4.0 | | 4.0 | 4.0 | 4.0 | 4.0 | 4.0 | 4.0 | 4.0 | 4.0 |
| All-Red Time (s) | 4.0 | | 4.0 | 4.0 | 1.0 | 3.0 | 1.0 | 3.0 | 4.0 | 1.0 |
| Lost Time Adjust (s) | -1.0 | | -1.0 | -1.0 | -1.0 | -1.0 | -1.0 | -1.0 | -1.0 | -1.0 |
| Total Lost Time (s) | 7.0 | | 7.0 | 7.0 | 4.0 | 6.0 | 4.0 | 6.0 | 7.0 | |
| Lead/Lag | Lead | | Lead | Lead | Lead | Lag | Lead | | Lag | Lag |
| Lead-Lag Optimize? | | | | | | | | | | |
| Act Effct Green (s) | 37.0 | 73.0 | 37.0 | 37.0 | 14.0 | 31.0 | 29.0 | 31.0 | 29.0 | |
| Actuated g/C Ratio | 0.25 | 0.49 | 0.25 | 0.25 | 0.09 | 0.21 | 0.19 | 0.21 | 0.19 | |
| v/c Ratio | 1.05 | 0.72 | 0.87 | 0.32 | 1.06 | 0.74 | 1.07 | 0.07 | 0.73 | |
| Control Delay | 110.2 | 37.1 | 38.9 | 45.7 | 148.9 | 63.3 | 126.4 | 48.9 | 65.5 | |
| Queue Delay | 0.0 | 0.0 | 0.0 | 0.0 | 0.0 | 0.0 | 0.0 | 0.0 | 0.0 | |
| Total Delay | 110.2 | 37.1 | 38.9 | 45.7 | 148.9 | 63.3 | 126.4 | 48.9 | 65.5 | |
| LOS | F | D | D | D | F | E | F | D | E | |
| Approach Delay | 61.0 | | | 45.7 | | 85.6 | | 121.6 | 65.5 | |
| Approach LOS | E | | | D | | F | | F | E | |
| Queue Length 50th (m) | -151.2 | 123.4 | 57.7 | 33.2 | -55.3 | 71.8 | -115.0 | 5.6 | 59.1 | |
| Queue Length 95th (m) | #219.0 | 169.4 | #121.3 | 46.5 | #102.8 | 92.0 | #177.3 | 13.9 | 77.7 | |
| Internal Link Dist (m) | 112.3 | | | 207.4 | | 413.3 | | 168.1 | 600.3 | |
| Turn Bay Length (m) | | 70.0 | 70.0 | | 100.0 | | | | | |
| Base Capacity (vph) | 445 | 747 | 525 | 832 | 162 | 658 | 326 | 308 | 556 | |
| Starvation Cap Reductn | 0 | 0 | 0 | 0 | 0 | 0 | 0 | 0 | 0 | |
| Spillback Cap Reductn | 0 | 0 | 0 | 0 | 0 | 0 | 0 | 0 | 0 | |
| Storage Cap Reductn | 0 | 0 | 0 | 0 | 0 | 0 | 0 | 0 | 0 | |
| Reduced v/c Ratio | 1.05 | 0.72 | 0.87 | 0.32 | 1.06 | 0.74 | 1.07 | 0.07 | 0.73 | |

Intersection Summary

Cycle Length: 150
 Actuated Cycle Length: 150
 Offset: 0 (0%), Referenced to phase 2:SBT and 6:NBT, Start of Green
 Natural Cycle: 150
 Control Type: Pretimed
 Maximum v/c Ratio: 1.07
 Intersection Signal Delay: 72.6
 Intersection Capacity Utilization 111.2%
 Analysis Period (min) 15
 - Volume exceeds capacity, queue is theoretically infinite.
 Queue shown is maximum after two cycles.
 # 95th percentile volume exceeds capacity, queue may be longer.
 Queue shown is maximum after two cycles.

Splits and Phases: 7: Robie & Bell & Quinpool/Cogswell

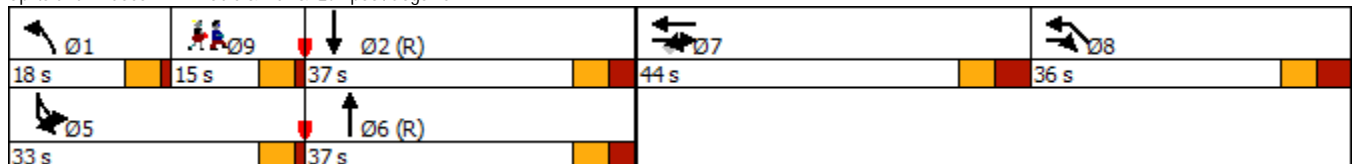

| | | | | | | | | | | Ø9 |
|------------------------|-------|--------|-------|-------|-------|-------|-------|-------|-------|------|
| Lane Group | EBL | EBT | WBL | WBT | WBR | NBL | NBT | SBL | SBT | Ø9 |
| Lane Configurations | | | | | | | | | | |
| Traffic Volume (vph) | 65 | 275 | 20 | 105 | 95 | 45 | 495 | 195 | 20 | |
| Future Volume (vph) | 65 | 275 | 20 | 105 | 95 | 45 | 495 | 195 | 20 | |
| Lane Group Flow (vph) | 0 | 485 | 0 | 143 | 108 | 51 | 622 | 223 | 23 | |
| Turn Type | Perm | NA | Perm | NA | Perm | Prot | NA | Prot | NA | |
| Protected Phases | | 8 | | 4 | | 5 | 2 | 1 | 6 | 9 |
| Permitted Phases | 8 | | 4 | | 4 | | | | | |
| Detector Phase | 8 | 8 | 4 | 4 | 4 | 5 | 2 | 1 | 6 | |
| Switch Phase | | | | | | | | | | |
| Minimum Initial (s) | 10.0 | 10.0 | 10.0 | 10.0 | 10.0 | 7.0 | 10.0 | 7.0 | 10.0 | 8.0 |
| Minimum Split (s) | 31.6 | 31.6 | 31.6 | 31.6 | 31.6 | 12.0 | 22.8 | 12.0 | 22.8 | 13.0 |
| Total Split (s) | 40.0 | 40.0 | 40.0 | 40.0 | 40.0 | 14.0 | 53.0 | 27.0 | 53.0 | 13.0 |
| Total Split (%) | 33.3% | 33.3% | 33.3% | 33.3% | 33.3% | 11.7% | 44.2% | 22.5% | 44.2% | 11% |
| Yellow Time (s) | 4.1 | 4.1 | 4.1 | 4.1 | 4.1 | 4.0 | 4.1 | 4.0 | 4.1 | 4.0 |
| All-Red Time (s) | 2.4 | 2.4 | 2.4 | 2.4 | 2.4 | 1.0 | 1.7 | 1.0 | 1.7 | 1.0 |
| Lost Time Adjust (s) | | 0.0 | | 0.0 | 0.0 | 0.0 | 0.0 | 0.0 | 0.0 | |
| Total Lost Time (s) | | 6.5 | | 6.5 | 6.5 | 5.0 | 5.8 | 5.0 | 5.8 | |
| Lead/Lag | | | | | | Lead | Lag | Lead | | Lag |
| Lead-Lag Optimize? | | | | | | | | | | |
| Recall Mode | Ped | Ped | Ped | Ped | Ped | None | C-Min | None | C-Min | None |
| Act Effct Green (s) | | 47.4 | | 47.4 | 47.4 | 8.4 | 35.5 | 19.8 | 49.3 | |
| Actuated g/C Ratio | | 0.40 | | 0.40 | 0.40 | 0.07 | 0.30 | 0.16 | 0.41 | |
| v/c Ratio | | 0.77 | | 0.22 | 0.19 | 0.47 | 0.67 | 0.82 | 0.03 | |
| Control Delay | | 41.6 | | 26.3 | 4.9 | 67.6 | 48.7 | 71.9 | 21.6 | |
| Queue Delay | | 0.0 | | 0.0 | 0.0 | 0.0 | 0.0 | 0.0 | 0.0 | |
| Total Delay | | 41.6 | | 26.3 | 4.9 | 67.6 | 48.7 | 71.9 | 21.6 | |
| LOS | | D | | C | A | E | D | E | C | |
| Approach Delay | | 41.6 | | 17.1 | | | 50.1 | | 67.2 | |
| Approach LOS | | D | | B | | | D | | E | |
| Queue Length 50th (m) | | 96.7 | | 22.2 | 0.0 | 12.0 | 79.6 | 50.2 | 3.3 | |
| Queue Length 95th (m) | | #162.6 | | 39.8 | 10.6 | m24.6 | 98.5 | #83.8 | 8.1 | |
| Internal Link Dist (m) | | 189.8 | | 183.6 | | | 355.1 | | 413.3 | |
| Turn Bay Length (m) | | | | | 40.0 | 50.0 | | | | |
| Base Capacity (vph) | | 628 | | 642 | 577 | 117 | 1229 | 302 | 716 | |
| Starvation Cap Reductn | | 0 | | 0 | 0 | 0 | 0 | 0 | 0 | |
| Spillback Cap Reductn | | 0 | | 0 | 0 | 0 | 0 | 0 | 0 | |
| Storage Cap Reductn | | 0 | | 0 | 0 | 0 | 0 | 0 | 0 | |
| Reduced v/c Ratio | | 0.77 | | 0.22 | 0.19 | 0.44 | 0.51 | 0.74 | 0.03 | |

Intersection Summary

Cycle Length: 120
 Actuated Cycle Length: 120
 Offset: 48 (40%), Referenced to phase 2:NBT and 6:SBT, Start of Green
 Natural Cycle: 80
 Control Type: Actuated-Coordinated
 Maximum v/c Ratio: 0.82
 Intersection Signal Delay: 45.1
 Intersection Capacity Utilization 78.4%
 Analysis Period (min) 15
 # 95th percentile volume exceeds capacity, queue may be longer.
 Queue shown is maximum after two cycles.
 m Volume for 95th percentile queue is metered by upstream signal.

Splits and Phases: 8: Robie & Jubilee/Veterans Memorial

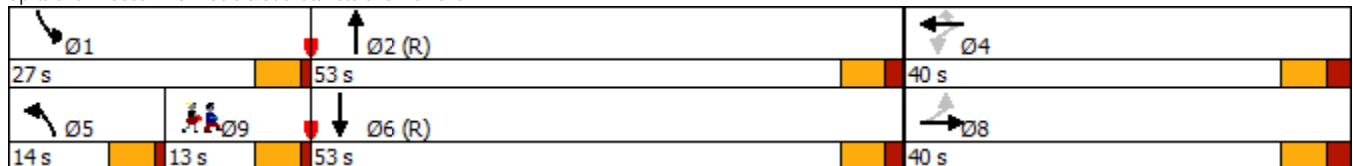

| Lane Group | EBL2 | EBT | WBL | WBT | NBL | NBT | SBL2 | SBL | SBT |
|------------------------|-------|-------|-------|-------|-------|-------|-------|-------|-------|
| Lane Configurations | | | | | | | | | |
| Traffic Volume (vph) | 45 | 170 | 45 | 150 | 50 | 409 | 204 | 8 | 10 |
| Future Volume (vph) | 45 | 170 | 45 | 150 | 50 | 409 | 204 | 8 | 10 |
| Lane Group Flow (vph) | 46 | 199 | 0 | 353 | 57 | 496 | 128 | 0 | 125 |
| Turn Type | Perm | NA | Perm | NA | Prot | NA | Prot | pm+pt | NA |
| Protected Phases | | 4 | | 4 | 5 | 2 | 1 | 9 | 6 |
| Permitted Phases | 4 | | 4 | | | | | 6 | |
| Detector Phase | 4 | 4 | 4 | 4 | 5 | 2 | 1 | 9 | 6 |
| Switch Phase | | | | | | | | | |
| Minimum Initial (s) | 10.0 | 10.0 | 10.0 | 10.0 | 8.0 | 10.0 | 8.0 | 8.0 | 10.0 |
| Minimum Split (s) | 33.5 | 33.5 | 33.5 | 33.5 | 13.0 | 34.5 | 13.0 | 13.0 | 34.5 |
| Total Split (s) | 45.0 | 45.0 | 45.0 | 45.0 | 17.0 | 45.0 | 17.0 | 13.0 | 58.0 |
| Total Split (%) | 37.5% | 37.5% | 37.5% | 37.5% | 14.2% | 37.5% | 14.2% | 10.8% | 48.3% |
| Yellow Time (s) | 4.1 | 4.1 | 4.1 | 4.1 | 4.0 | 4.1 | 4.0 | 4.0 | 4.1 |
| All-Red Time (s) | 2.4 | 2.4 | 2.4 | 2.4 | 1.0 | 2.4 | 1.0 | 1.0 | 2.4 |
| Lost Time Adjust (s) | 0.0 | 0.0 | | 0.0 | 0.0 | 0.0 | 0.0 | | 0.0 |
| Total Lost Time (s) | 6.5 | 6.5 | | 6.5 | 5.0 | 6.5 | 5.0 | | 6.5 |
| Lead/Lag | | | | | Lead | | Lead | Lag | Lag |
| Lead-Lag Optimize? | | | | | | | | | |
| Recall Mode | None | None | None | None | None | C-Max | Max | None | C-Max |
| Act Effct Green (s) | 26.0 | 26.0 | | 26.0 | 9.8 | 51.5 | 24.5 | | 68.8 |
| Actuated g/C Ratio | 0.22 | 0.22 | | 0.22 | 0.08 | 0.43 | 0.20 | | 0.57 |
| v/c Ratio | 0.33 | 0.53 | | 0.82 | 0.40 | 0.35 | 0.38 | | 0.45 |
| Control Delay | 43.8 | 45.9 | | 60.5 | 60.3 | 17.7 | 42.6 | | 35.7 |
| Queue Delay | 0.0 | 0.0 | | 0.0 | 0.0 | 0.0 | 0.0 | | 0.0 |
| Total Delay | 43.8 | 45.9 | | 60.5 | 60.3 | 17.7 | 42.6 | | 35.7 |
| LOS | D | D | | E | E | B | D | | D |
| Approach Delay | | 45.5 | | 60.5 | | 22.1 | | | 39.2 |
| Approach LOS | | D | | E | | C | | | D |
| Queue Length 50th (m) | 9.6 | 43.8 | | 41.8 | 13.0 | 29.8 | 29.5 | | 20.5 |
| Queue Length 95th (m) | 19.8 | 62.3 | | 54.4 | 25.8 | 42.8 | m47.3 | | m45.2 |
| Internal Link Dist (m) | | 121.4 | | 124.9 | | 240.3 | | | 355.1 |
| Turn Bay Length (m) | 30.0 | | | | 60.0 | | | | |
| Base Capacity (vph) | 209 | 552 | | 633 | 176 | 1400 | 339 | | 276 |
| Starvation Cap Reductn | 0 | 0 | | 0 | 0 | 0 | 0 | | 0 |
| Spillback Cap Reductn | 0 | 0 | | 0 | 0 | 0 | 0 | | 0 |
| Storage Cap Reductn | 0 | 0 | | 0 | 0 | 0 | 0 | | 0 |
| Reduced v/c Ratio | 0.22 | 0.36 | | 0.56 | 0.32 | 0.35 | 0.38 | | 0.45 |

Intersection Summary

Cycle Length: 120
 Actuated Cycle Length: 120
 Offset: 82 (68%), Referenced to phase 2:NBT and 6:SBTL, Start of Green
 Natural Cycle: 95
 Control Type: Actuated-Coordinated
 Maximum v/c Ratio: 0.82
 Intersection Signal Delay: 38.9
 Intersection Capacity Utilization 101.5%
 Analysis Period (min) 15
 m Volume for 95th percentile queue is metered by upstream signal.

Splits and Phases: 9: Robie & Coburg/Spring Garden

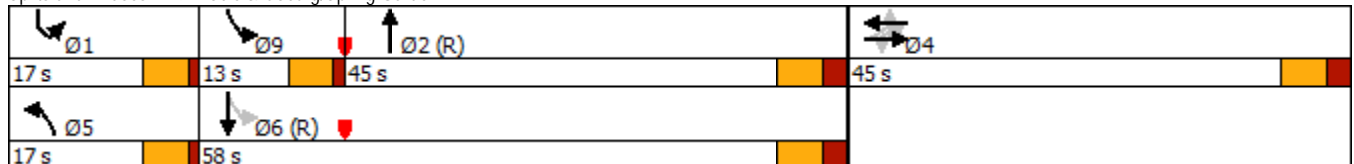

| | | | | | | | | | | | Ø9 |
|------------------------|-------|-------|-------|-------|-------|-------|-------|-------|-------|-------|------|
| Lane Group | EBL | EBT | WBL | WBT | WBR | NBL | NBT | SBL2 | SBL | SBT | Ø9 |
| Lane Configurations | | | | | | | | | | | |
| Traffic Volume (vph) | 30 | 145 | 30 | 85 | 95 | 10 | 301 | 342 | 3 | 6 | |
| Future Volume (vph) | 30 | 145 | 30 | 85 | 95 | 10 | 301 | 342 | 3 | 6 | |
| Lane Group Flow (vph) | 34 | 194 | 34 | 97 | 108 | 11 | 390 | 199 | 0 | 201 | |
| Turn Type | Perm | NA | Perm | NA | pm+ov | Prot | NA | Prot | Perm | NA | |
| Protected Phases | | 8 | | 4 | 5 | 1 | 6 | 5 | | 2 | 9 |
| Permitted Phases | 8 | | 4 | | 4 | | | | 2 | | |
| Detector Phase | 8 | 8 | 4 | 4 | 5 | 1 | 6 | 5 | 2 | 2 | |
| Switch Phase | | | | | | | | | | | |
| Minimum Initial (s) | 10.0 | 10.0 | 10.0 | 10.0 | 8.0 | 8.0 | 10.0 | 8.0 | 10.0 | 10.0 | 8.0 |
| Minimum Split (s) | 32.5 | 32.5 | 32.5 | 32.5 | 13.0 | 13.0 | 43.3 | 13.0 | 43.3 | 43.3 | 13.0 |
| Total Split (s) | 33.0 | 33.0 | 33.0 | 33.0 | 38.0 | 13.0 | 44.0 | 38.0 | 44.0 | 44.0 | 25.0 |
| Total Split (%) | 28.7% | 28.7% | 28.7% | 28.7% | 33.0% | 11.3% | 38.3% | 33.0% | 38.3% | 38.3% | 22% |
| Yellow Time (s) | 4.1 | 4.1 | 4.1 | 4.1 | 4.0 | 4.0 | 4.1 | 4.0 | 4.1 | 4.1 | 4.0 |
| All-Red Time (s) | 2.4 | 2.4 | 2.4 | 2.4 | 1.0 | 1.0 | 3.2 | 1.0 | 3.2 | 3.2 | 1.0 |
| Lost Time Adjust (s) | 0.0 | 0.0 | 0.0 | 0.0 | 0.0 | 0.0 | 0.0 | 0.0 | 0.0 | 0.0 | |
| Total Lost Time (s) | 6.5 | 6.5 | 6.5 | 6.5 | 5.0 | 5.0 | 7.3 | 5.0 | | 7.3 | |
| Lead/Lag | | | | | Lead | Lead | Lag | Lead | | | Lag |
| Lead-Lag Optimize? | | | | | | | | | | | |
| Recall Mode | Ped | Ped | Ped | Ped | None | None | C-Max | None | C-Max | C-Max | None |
| Act Effct Green (s) | 26.0 | 26.0 | 26.0 | 26.0 | 46.9 | 8.0 | 50.8 | 19.4 | | 72.6 | |
| Actuated g/C Ratio | 0.23 | 0.23 | 0.23 | 0.23 | 0.41 | 0.07 | 0.44 | 0.17 | | 0.63 | |
| v/c Ratio | 0.18 | 0.42 | 0.18 | 0.26 | 0.22 | 0.09 | 0.31 | 0.73 | | 0.68 | |
| Control Delay | 38.9 | 15.7 | 39.1 | 39.0 | 6.9 | 47.2 | 27.7 | 59.9 | | 29.8 | |
| Queue Delay | 0.0 | 0.0 | 0.0 | 0.0 | 0.0 | 0.0 | 0.0 | 0.0 | | 0.0 | |
| Total Delay | 38.9 | 15.7 | 39.1 | 39.0 | 6.9 | 47.2 | 27.7 | 59.9 | | 29.8 | |
| LOS | D | B | D | D | A | D | C | E | | C | |
| Approach Delay | | 19.1 | | 24.5 | | | 28.2 | | | 44.7 | |
| Approach LOS | | B | | C | | | C | | | D | |
| Queue Length 50th (m) | 6.2 | 10.6 | 6.2 | 18.1 | 3.5 | 2.4 | 28.4 | 45.1 | | 26.4 | |
| Queue Length 95th (m) | 15.3 | 31.1 | 15.3 | 33.1 | 11.9 | m6.2 | 38.1 | 66.4 | | #84.3 | |
| Internal Link Dist (m) | | 178.0 | | 171.4 | | | 167.5 | | | 240.3 | |
| Turn Bay Length (m) | 15.0 | | 15.0 | | 60.0 | 60.0 | | 60.0 | | | |
| Base Capacity (vph) | 193 | 465 | 189 | 374 | 639 | 117 | 1277 | 467 | | 296 | |
| Starvation Cap Reductn | 0 | 0 | 0 | 0 | 0 | 0 | 0 | 0 | | 0 | |
| Spillback Cap Reductn | 0 | 0 | 0 | 0 | 0 | 0 | 0 | 0 | | 0 | |
| Storage Cap Reductn | 0 | 0 | 0 | 0 | 0 | 0 | 0 | 0 | | 0 | |
| Reduced v/c Ratio | 0.18 | 0.42 | 0.18 | 0.26 | 0.17 | 0.09 | 0.31 | 0.43 | | 0.68 | |

Intersection Summary

Cycle Length: 115
 Actuated Cycle Length: 115
 Offset: 108 (94%), Referenced to phase 2:SBTL and 6:NBT, Start of Green
 Natural Cycle: 105
 Control Type: Actuated-Coordinated
 Maximum v/c Ratio: 0.73
 Intersection Signal Delay: 31.1
 Intersection Capacity Utilization 103.8%
 Analysis Period (min) 15
 # 95th percentile volume exceeds capacity, queue may be longer.
 Queue shown is maximum after two cycles.
 m Volume for 95th percentile queue is metered by upstream signal.

Splits and Phases: 10: Robie & University

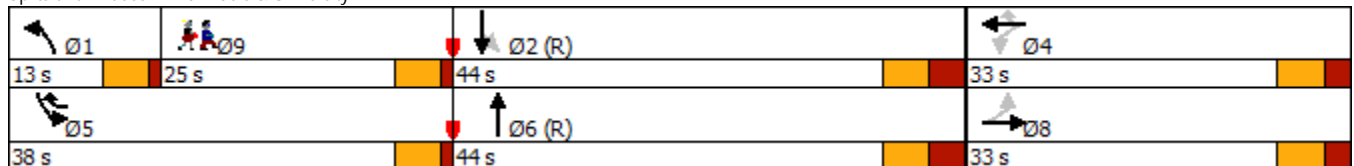

| | | | | | | | | | | | | Ø9 |
|------------------------|-------|-------|-------|-------|-------|-------|-------|-------|-------|-------|--|------|
| Lane Group | EBL2 | EBT | WBL | WBT | WBR | NBL | NBT | SBL2 | SBL | SBT | | |
| Lane Configurations | | | | | | | | | | | | |
| Traffic Volume (vph) | 50 | 290 | 10 | 135 | 105 | 22 | 221 | 171 | 4 | 0 | | |
| Future Volume (vph) | 50 | 290 | 10 | 135 | 105 | 22 | 221 | 171 | 4 | 0 | | |
| Lane Group Flow (vph) | 0 | 422 | 0 | 165 | 120 | 25 | 286 | 101 | 0 | 101 | | |
| Turn Type | Perm | NA | Perm | NA | Perm | Prot | NA | Prot | Perm | NA | | |
| Protected Phases | | 4 | | 4 | | 5 | 2 | 1 | | 6 | | 9 |
| Permitted Phases | 4 | | 4 | | 4 | | | | 6 | | | |
| Detector Phase | 4 | 4 | 4 | 4 | 4 | 5 | 2 | 1 | 6 | 6 | | |
| Switch Phase | | | | | | | | | | | | |
| Minimum Initial (s) | 10.0 | 10.0 | 10.0 | 10.0 | 10.0 | 8.0 | 10.0 | 8.0 | 10.0 | 10.0 | | 4.0 |
| Minimum Split (s) | 47.8 | 47.8 | 47.8 | 47.8 | 47.8 | 13.0 | 24.7 | 13.0 | 24.7 | 24.7 | | 6.0 |
| Total Split (s) | 51.0 | 51.0 | 51.0 | 51.0 | 51.0 | 13.0 | 45.0 | 19.0 | 45.0 | 45.0 | | 6.0 |
| Total Split (%) | 44.3% | 44.3% | 44.3% | 44.3% | 44.3% | 11.3% | 39.1% | 16.5% | 39.1% | 39.1% | | 5% |
| Yellow Time (s) | 4.1 | 4.1 | 4.1 | 4.1 | 4.1 | 4.0 | 4.1 | 4.0 | 4.1 | 4.1 | | 2.0 |
| All-Red Time (s) | 2.7 | 2.7 | 2.7 | 2.7 | 2.7 | 1.0 | 1.6 | 1.0 | 1.6 | 1.6 | | 0.0 |
| Lost Time Adjust (s) | | 0.0 | | 0.0 | 0.0 | 0.0 | 0.0 | 0.0 | | 0.0 | | |
| Total Lost Time (s) | | 6.8 | | 6.8 | 6.8 | 5.0 | 5.7 | 5.0 | | 5.7 | | |
| Lead/Lag | | | | | | Lead | Lag | Lead | | | | Lag |
| Lead-Lag Optimize? | | | | | | | | | | | | |
| Recall Mode | Ped | Ped | Ped | Ped | Ped | None | C-Min | Min | C-Min | C-Min | | None |
| Act Effct Green (s) | | 43.2 | | 43.2 | 43.2 | 8.4 | 41.9 | 12.4 | | 51.1 | | |
| Actuated g/C Ratio | | 0.38 | | 0.38 | 0.38 | 0.07 | 0.36 | 0.11 | | 0.44 | | |
| v/c Ratio | | 0.76 | | 0.25 | 0.23 | 0.22 | 0.43 | 0.57 | | 0.32 | | |
| Control Delay | | 41.1 | | 25.4 | 25.2 | 54.7 | 18.2 | 56.7 | | 9.4 | | |
| Queue Delay | | 0.0 | | 0.0 | 0.0 | 0.0 | 0.0 | 0.0 | | 0.0 | | |
| Total Delay | | 41.1 | | 25.4 | 25.2 | 54.7 | 18.2 | 56.7 | | 9.4 | | |
| LOS | | D | | C | C | D | B | E | | A | | |
| Approach Delay | | 41.1 | | 25.3 | | | 21.1 | | | 33.0 | | |
| Approach LOS | | D | | C | | | C | | | C | | |
| Queue Length 50th (m) | | 84.2 | | 26.2 | 18.9 | 5.4 | 23.9 | 23.4 | | 0.0 | | |
| Queue Length 95th (m) | | 111.2 | | 38.0 | 29.5 | 14.0 | 56.0 | m40.8 | | m11.6 | | |
| Internal Link Dist (m) | | 115.5 | | 183.6 | | | 422.3 | | | 167.5 | | |
| Turn Bay Length (m) | | | | | 50.0 | | | 60.0 | | | | |
| Base Capacity (vph) | | 577 | | 680 | 544 | 115 | 680 | 212 | | 317 | | |
| Starvation Cap Reductn | | 0 | | 0 | 0 | 0 | 0 | 0 | | 0 | | |
| Spillback Cap Reductn | | 0 | | 0 | 0 | 0 | 0 | 0 | | 0 | | |
| Storage Cap Reductn | | 0 | | 0 | 0 | 0 | 0 | 0 | | 0 | | |
| Reduced v/c Ratio | | 0.73 | | 0.24 | 0.22 | 0.22 | 0.42 | 0.48 | | 0.32 | | |

Intersection Summary

Cycle Length: 115
 Actuated Cycle Length: 115
 Offset: 0 (0%), Referenced to phase 2:NBT and 6:SBTL, Start of Green
 Natural Cycle: 95
 Control Type: Actuated-Coordinated
 Maximum v/c Ratio: 0.76
 Intersection Signal Delay: 31.0
 Intersection Capacity Utilization 120.8%
 Analysis Period (min) 15
 m Volume for 95th percentile queue is metered by upstream signal.

Intersection LOS: C
 ICU Level of Service H

Splits and Phases: 11: Robie & South

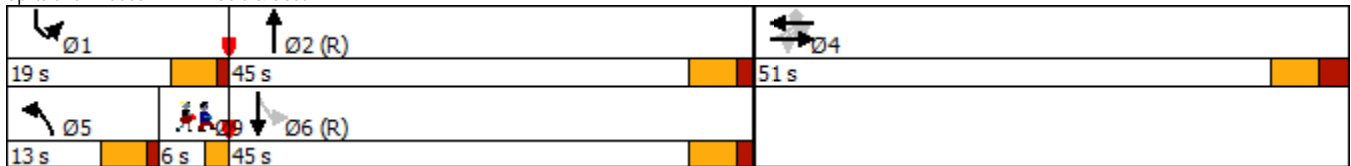

| Lane Group | EBL | EBT | WBL | WBT | WBR | NBL | NBT | SBL | SBT | SBR |
|------------------------|-------|-------|-------|-------|--------|-------|-------|-------|-------|-------|
| Lane Configurations | | | | | | | | | | |
| Traffic Volume (vph) | 20 | 260 | 65 | 185 | 170 | 10 | 40 | 210 | 105 | 20 |
| Future Volume (vph) | 20 | 260 | 65 | 185 | 170 | 10 | 40 | 210 | 105 | 20 |
| Lane Group Flow (vph) | 0 | 371 | 0 | 285 | 194 | 0 | 108 | 240 | 120 | 23 |
| Turn Type | Perm | NA | Perm | NA | custom | Perm | NA | pm+pt | NA | Perm |
| Protected Phases | | 8 | | 4 | | | 6 | 5 | 2 | |
| Permitted Phases | 8 | | 4 | | 4 5 | 6 | | 2 | | 2 |
| Detector Phase | 8 | 8 | 4 | 4 | 4 5 | 6 | 6 | 5 | 2 | 2 |
| Switch Phase | | | | | | | | | | |
| Minimum Initial (s) | 10.0 | 10.0 | 10.0 | 10.0 | | 10.0 | 10.0 | 8.0 | 10.0 | 10.0 |
| Minimum Split (s) | 31.7 | 31.7 | 31.7 | 31.7 | | 23.1 | 23.1 | 11.0 | 23.1 | 23.1 |
| Total Split (s) | 40.0 | 40.0 | 40.0 | 40.0 | | 39.0 | 39.0 | 11.0 | 50.0 | 50.0 |
| Total Split (%) | 44.4% | 44.4% | 44.4% | 44.4% | | 43.3% | 43.3% | 12.2% | 55.6% | 55.6% |
| Yellow Time (s) | 4.1 | 4.1 | 4.1 | 4.1 | | 4.1 | 4.1 | 3.0 | 4.1 | 4.1 |
| All-Red Time (s) | 2.6 | 2.6 | 2.6 | 2.6 | | 2.0 | 2.0 | 0.0 | 2.0 | 2.0 |
| Lost Time Adjust (s) | | 0.0 | | 0.0 | | | 0.0 | 0.0 | 0.0 | 0.0 |
| Total Lost Time (s) | | 6.7 | | 6.7 | | | 6.1 | 3.0 | 6.1 | 6.1 |
| Lead/Lag | | | | | | Lag | Lag | Lead | | |
| Lead-Lag Optimize? | | | | | | | | | | |
| Recall Mode | Ped | Ped | Max | Max | | C-Min | C-Min | None | C-Min | C-Min |
| Act Effct Green (s) | | 54.8 | | 54.8 | 65.8 | | 11.4 | 25.5 | 22.4 | 22.4 |
| Actuated g/C Ratio | | 0.61 | | 0.61 | 0.73 | | 0.13 | 0.28 | 0.25 | 0.25 |
| v/c Ratio | | 0.35 | | 0.33 | 0.18 | | 0.51 | 0.78 | 0.31 | 0.07 |
| Control Delay | | 10.1 | | 10.4 | 1.1 | | 29.5 | 46.9 | 29.5 | 3.4 |
| Queue Delay | | 0.0 | | 0.0 | 0.0 | | 0.0 | 0.0 | 0.0 | 0.0 |
| Total Delay | | 10.1 | | 10.4 | 1.1 | | 29.5 | 46.9 | 29.5 | 3.4 |
| LOS | | B | | B | A | | C | D | C | A |
| Approach Delay | | 10.1 | | 6.6 | | | 29.5 | | 38.8 | |
| Approach LOS | | B | | A | | | C | | D | |
| Queue Length 50th (m) | | 26.9 | | 21.0 | 0.0 | | 9.3 | 35.6 | 17.3 | 0.0 |
| Queue Length 95th (m) | | 50.2 | | 41.2 | 5.6 | | 23.7 | #57.7 | 29.8 | 2.6 |
| Internal Link Dist (m) | | 113.9 | | 142.4 | | | 118.8 | | 422.3 | |
| Turn Bay Length (m) | | | | | 50.0 | | | 60.0 | | 20.0 |
| Base Capacity (vph) | | 1047 | | 854 | 1092 | | 509 | 306 | 756 | 576 |
| Starvation Cap Reductn | | 0 | | 0 | 0 | | 0 | 0 | 0 | 0 |
| Spillback Cap Reductn | | 0 | | 0 | 0 | | 0 | 0 | 0 | 0 |
| Storage Cap Reductn | | 0 | | 0 | 0 | | 0 | 0 | 0 | 0 |
| Reduced v/c Ratio | | 0.35 | | 0.33 | 0.18 | | 0.21 | 0.78 | 0.16 | 0.04 |

Intersection Summary

Cycle Length: 90
 Actuated Cycle Length: 90
 Offset: 0 (0%), Referenced to phase 2:SBTL and 6:NBTL, Start of Green
 Natural Cycle: 70
 Control Type: Actuated-Coordinated
 Maximum v/c Ratio: 0.78
 Intersection Signal Delay: 18.6
 Intersection Capacity Utilization 72.1%
 Analysis Period (min) 15
 # 95th percentile volume exceeds capacity, queue may be longer.
 Queue shown is maximum after two cycles.

Splits and Phases: 12: Robie & Inglis

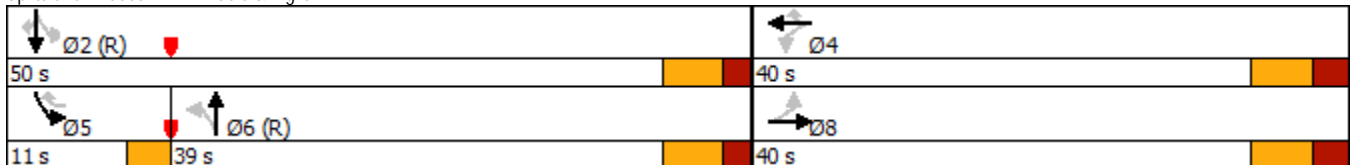

| Lane Group | EBL | EBT | WBL | WBT | WBR | NBT | SBL | SBT |
|------------------------|-------|-------|-------|--------|-------|-------|-------|-------|
| Lane Configurations | | | | | | | | |
| Traffic Volume (vph) | 190 | 195 | 15 | 470 | 125 | 13 | 20 | 369 |
| Future Volume (vph) | 190 | 195 | 15 | 470 | 125 | 13 | 20 | 369 |
| Lane Group Flow (vph) | 217 | 291 | 0 | 553 | 143 | 15 | 23 | 569 |
| Turn Type | pm+pt | NA | Perm | NA | Perm | NA | Prot | NA |
| Protected Phases | 3 | 8 | | 4 | | 2 | 1! | 2 |
| Permitted Phases | 8 | | 4 | | 4 | | | |
| Detector Phase | 3 | 8 | 4 | 4 | 4 | 2 | 1 | 2 |
| Switch Phase | | | | | | | | |
| Minimum Initial (s) | 7.0 | 10.0 | 10.0 | 10.0 | 10.0 | 10.0 | 8.0 | 10.0 |
| Minimum Split (s) | 11.0 | 50.0 | 37.0 | 37.0 | 37.0 | 40.0 | 13.0 | 40.0 |
| Total Split (s) | 14.0 | 52.0 | 38.0 | 38.0 | 38.0 | 55.0 | 13.0 | 55.0 |
| Total Split (%) | 11.7% | 43.3% | 31.7% | 31.7% | 31.7% | 45.8% | 10.8% | 45.8% |
| Yellow Time (s) | 4.0 | 4.1 | 4.1 | 4.1 | 4.1 | 4.1 | 4.0 | 4.1 |
| All-Red Time (s) | 0.0 | 2.1 | 2.1 | 2.1 | 2.1 | 1.7 | 1.0 | 1.7 |
| Lost Time Adjust (s) | 0.0 | 0.0 | | 0.0 | 0.0 | 0.0 | 0.0 | 0.0 |
| Total Lost Time (s) | 4.0 | 6.2 | | 6.2 | 6.2 | 5.8 | 5.0 | 5.8 |
| Lead/Lag | Lead | | Lag | Lag | Lag | Lag | Lead | Lag |
| Lead-Lag Optimize? | | | | | | | | |
| Recall Mode | None | None | None | None | None | C-Min | None | C-Min |
| Act Effct Green (s) | 53.1 | 50.9 | | 32.6 | 32.6 | 49.3 | 8.0 | 49.3 |
| Actuated g/C Ratio | 0.44 | 0.42 | | 0.27 | 0.27 | 0.41 | 0.07 | 0.41 |
| v/c Ratio | 0.80 | 0.40 | | 0.95 | 0.31 | 0.02 | 0.20 | 0.81 |
| Control Delay | 50.4 | 25.8 | | 69.8 | 12.9 | 21.6 | 73.0 | 20.6 |
| Queue Delay | 0.0 | 0.0 | | 0.0 | 0.0 | 0.0 | 0.0 | 0.0 |
| Total Delay | 50.4 | 25.8 | | 69.8 | 12.9 | 21.6 | 73.0 | 20.6 |
| LOS | D | C | | E | B | C | E | C |
| Approach Delay | | 36.3 | | 58.1 | | 21.6 | | 22.7 |
| Approach LOS | | D | | E | | C | | C |
| Queue Length 50th (m) | 34.8 | 45.7 | | 129.3 | 6.4 | 2.2 | 5.8 | 34.1 |
| Queue Length 95th (m) | #88.5 | 72.4 | | #198.2 | 23.1 | 6.3 | m9.6 | #48.2 |
| Internal Link Dist (m) | | 253.6 | | 227.2 | | 402.8 | | 360.9 |
| Turn Bay Length (m) | 80.0 | | | | 50.0 | | 180.0 | |
| Base Capacity (vph) | 270 | 735 | | 584 | 456 | 729 | 115 | 709 |
| Starvation Cap Reductn | 0 | 0 | | 0 | 0 | 0 | 0 | 0 |
| Spillback Cap Reductn | 0 | 0 | | 0 | 0 | 0 | 0 | 0 |
| Storage Cap Reductn | 0 | 0 | | 0 | 0 | 0 | 0 | 0 |
| Reduced v/c Ratio | 0.80 | 0.40 | | 0.95 | 0.31 | 0.02 | 0.20 | 0.80 |

Intersection Summary

Cycle Length: 120
 Actuated Cycle Length: 120
 Offset: 76 (63%), Referenced to phase 2:NBSB and 6:, Start of Green
 Natural Cycle: 105
 Control Type: Actuated-Coordinated
 Maximum v/c Ratio: 0.95
 Intersection Signal Delay: 40.1
 Intersection Capacity Utilization 105.1%
 Analysis Period (min) 15
 # 95th percentile volume exceeds capacity, queue may be longer.
 Queue shown is maximum after two cycles.
 m Volume for 95th percentile queue is metered by upstream signal.
 ! Phase conflict between lane groups.

Splits and Phases: 4: Robie & Almon

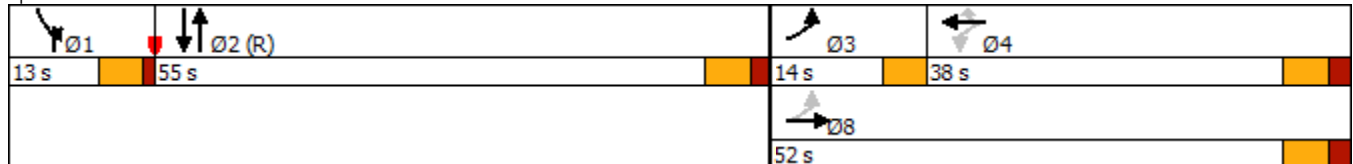

| | → | ← | ↑ | ↓ |
|------------------------|-------|--------|-------|-------|
| Lane Group | EBT | WBT | NBT | SBT |
| Lane Configurations | ↗ | ↖ | ↗ | ↖ |
| Traffic Volume (vph) | 345 | 445 | 13 | 514 |
| Future Volume (vph) | 345 | 445 | 13 | 514 |
| Lane Group Flow (vph) | 423 | 531 | 15 | 621 |
| Turn Type | NA | NA | NA | NA |
| Protected Phases | 8 | 4 | 2 | 2 |
| Permitted Phases | | | | |
| Detector Phase | 8 | 4 | 2 | 2 |
| Switch Phase | | | | |
| Minimum Initial (s) | 10.0 | 10.0 | 10.0 | 10.0 |
| Minimum Split (s) | 23.7 | 23.7 | 54.0 | 54.0 |
| Total Split (s) | 36.0 | 36.0 | 54.0 | 54.0 |
| Total Split (%) | 40.0% | 40.0% | 60.0% | 60.0% |
| Yellow Time (s) | 4.1 | 4.1 | 4.1 | 4.1 |
| All-Red Time (s) | 1.6 | 1.6 | 1.5 | 1.5 |
| Lost Time Adjust (s) | 0.0 | 0.0 | 0.0 | 0.0 |
| Total Lost Time (s) | 5.7 | 5.7 | 5.6 | 5.6 |
| Lead/Lag | | | | |
| Lead-Lag Optimize? | | | | |
| Recall Mode | Ped | Ped | C-Max | C-Max |
| Act Effct Green (s) | 28.5 | 28.5 | 50.2 | 50.2 |
| Actuated g/C Ratio | 0.32 | 0.32 | 0.56 | 0.56 |
| v/c Ratio | 0.76 | 0.91 | 0.02 | 0.63 |
| Control Delay | 36.8 | 50.1 | 9.8 | 17.6 |
| Queue Delay | 0.0 | 0.0 | 0.0 | 0.0 |
| Total Delay | 36.8 | 50.1 | 9.8 | 17.6 |
| LOS | D | D | A | B |
| Approach Delay | 36.8 | 50.1 | 9.8 | 17.6 |
| Approach LOS | D | D | A | B |
| Queue Length 50th (m) | 62.5 | 84.0 | 1.2 | 71.3 |
| Queue Length 95th (m) | 95.6 | #139.1 | 3.9 | 107.2 |
| Internal Link Dist (m) | 171.5 | 199.1 | 446.6 | 402.8 |
| Turn Bay Length (m) | | | | |
| Base Capacity (vph) | 594 | 623 | 971 | 989 |
| Starvation Cap Reductn | 0 | 0 | 0 | 0 |
| Spillback Cap Reductn | 0 | 0 | 0 | 0 |
| Storage Cap Reductn | 0 | 0 | 0 | 0 |
| Reduced v/c Ratio | 0.71 | 0.85 | 0.02 | 0.63 |

Intersection Summary

Cycle Length: 90
 Actuated Cycle Length: 90
 Offset: 0 (0%), Referenced to phase 2:NBSB, Start of Green
 Natural Cycle: 90
 Control Type: Actuated-Coordinated
 Maximum v/c Ratio: 0.91
 Intersection Signal Delay: 33.5
 Intersection Capacity Utilization 75.9%
 Analysis Period (min) 15
 # 95th percentile volume exceeds capacity, queue may be longer.
 Queue shown is maximum after two cycles.

Intersection LOS: C
 ICU Level of Service D

Splits and Phases: 5: Robie & North

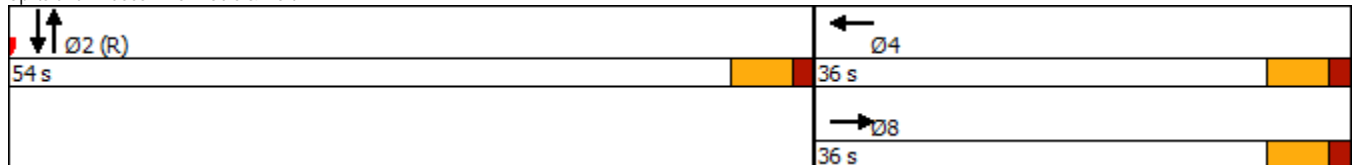

| Lane Group | EBL | EBT | WBL | WBT | WBR2 | NBL2 | NBL | NBT | SBL | SBT |
|------------------------|-------|--------|-------|--------|-------|-------|-------|-------|-------|-------|
| Lane Configurations | | | | | | | | | | |
| Traffic Volume (vph) | 20 | 300 | 65 | 475 | 75 | 42 | 8 | 13 | 55 | 534 |
| Future Volume (vph) | 20 | 300 | 65 | 475 | 75 | 42 | 8 | 13 | 55 | 534 |
| Lane Group Flow (vph) | 23 | 410 | 74 | 542 | 86 | 38 | 0 | 34 | 63 | 666 |
| Turn Type | Perm | NA | Perm | NA | Perm | Prot | pm+pt | NA | Prot | NA |
| Protected Phases | | 8 | | 4 | | 5 | 9 | 2 | 1 | 6 |
| Permitted Phases | 8 | | 4 | | 4 | | 2 | | | |
| Detector Phase | 8 | 8 | 4 | 4 | 4 | 5 | 9 | 2 | 1 | 6 |
| Switch Phase | | | | | | | | | | |
| Minimum Initial (s) | 10.0 | 10.0 | 10.0 | 10.0 | 10.0 | 8.0 | 8.0 | 10.0 | 8.0 | 8.0 |
| Minimum Split (s) | 39.1 | 39.1 | 39.1 | 39.1 | 39.1 | 13.0 | 13.0 | 37.9 | 13.0 | 24.0 |
| Total Split (s) | 43.0 | 43.0 | 43.0 | 43.0 | 43.0 | 14.0 | 13.0 | 63.0 | 14.0 | 50.0 |
| Total Split (%) | 35.8% | 35.8% | 35.8% | 35.8% | 35.8% | 11.7% | 10.8% | 52.5% | 11.7% | 41.7% |
| Yellow Time (s) | 4.1 | 4.1 | 4.1 | 4.1 | 4.1 | 4.0 | 4.0 | 4.1 | 4.0 | 4.0 |
| All-Red Time (s) | 3.0 | 3.0 | 3.0 | 3.0 | 3.0 | 1.0 | 0.0 | 2.0 | 1.0 | 2.0 |
| Lost Time Adjust (s) | 0.0 | 0.0 | 0.0 | 0.0 | 0.0 | 0.0 | | 0.0 | 0.0 | 0.0 |
| Total Lost Time (s) | 7.1 | 7.1 | 7.1 | 7.1 | 7.1 | 5.0 | | 6.1 | 5.0 | 6.0 |
| Lead/Lag | | | | | | Lead | Lag | Lag | Lead | |
| Lead-Lag Optimize? | | | | | | | | | | |
| Recall Mode | Ped | Ped | Ped | Ped | Ped | None | None | C-Max | None | C-Max |
| Act Effct Green (s) | 35.9 | 35.9 | 35.9 | 35.9 | 35.9 | 8.4 | | 59.9 | 8.6 | 62.8 |
| Actuated g/C Ratio | 0.30 | 0.30 | 0.30 | 0.30 | 0.30 | 0.07 | | 0.50 | 0.07 | 0.52 |
| v/c Ratio | 0.48 | 0.95 | 0.54 | 0.99 | 0.18 | 0.34 | | 0.06 | 0.51 | 0.71 |
| Control Delay | 70.5 | 73.7 | 51.7 | 79.6 | 4.0 | 61.7 | | 17.5 | 68.2 | 28.4 |
| Queue Delay | 0.0 | 0.0 | 0.0 | 0.0 | 0.0 | 0.0 | | 0.0 | 0.0 | 0.0 |
| Total Delay | 70.5 | 73.7 | 51.7 | 79.6 | 4.0 | 61.7 | | 17.5 | 68.2 | 28.4 |
| LOS | E | E | D | E | A | E | | B | E | C |
| Approach Delay | | 73.5 | | 67.4 | | | | 40.8 | | 31.8 |
| Approach LOS | | E | | E | | | | D | | C |
| Queue Length 50th (m) | 4.4 | 94.3 | 14.5 | 127.2 | 0.0 | 9.1 | | 4.4 | 14.5 | 125.4 |
| Queue Length 95th (m) | #17.0 | #155.0 | 32.1 | #198.0 | 7.3 | 20.9 | | 10.6 | 29.1 | 176.9 |
| Internal Link Dist (m) | | 72.7 | | 213.1 | | | | 402.3 | | 446.6 |
| Turn Bay Length (m) | 50.0 | | | | 50.0 | 40.0 | | | 40.0 | |
| Base Capacity (vph) | 48 | 433 | 138 | 545 | 468 | 119 | | 605 | 129 | 942 |
| Starvation Cap Reductn | 0 | 0 | 0 | 0 | 0 | 0 | | 0 | 0 | 0 |
| Spillback Cap Reductn | 0 | 0 | 0 | 0 | 0 | 0 | | 0 | 0 | 0 |
| Storage Cap Reductn | 0 | 0 | 0 | 0 | 0 | 0 | | 0 | 0 | 0 |
| Reduced v/c Ratio | 0.48 | 0.95 | 0.54 | 0.99 | 0.18 | 0.32 | | 0.06 | 0.49 | 0.71 |

Intersection Summary

Cycle Length: 120
 Actuated Cycle Length: 120
 Offset: 0 (0%), Referenced to phase 2:NBT and 6:SBT, Start of Green
 Natural Cycle: 120
 Control Type: Actuated-Coordinated
 Maximum v/c Ratio: 0.99
 Intersection Signal Delay: 54.4
 Intersection Capacity Utilization 84.5%
 Analysis Period (min) 15
 # 95th percentile volume exceeds capacity, queue may be longer.
 Queue shown is maximum after two cycles.

Splits and Phases: 6: Robie & Cunard

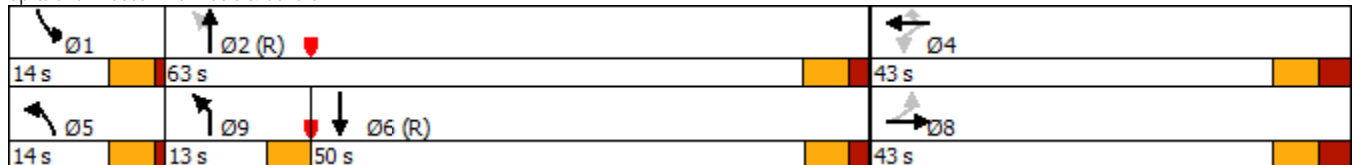

| Lane Group | EBT | EBR | EBR2 | WBT | NBL | NBT | SBL | SBT | NWL |
|------------------------|-------|-------|-------|--------|--------|-------|--------|-------|--------|
| Lane Configurations | | | | | | | | | |
| Traffic Volume (vph) | 215 | 295 | 140 | 535 | 245 | 19 | 140 | 542 | 625 |
| Future Volume (vph) | 215 | 295 | 140 | 535 | 245 | 19 | 140 | 542 | 625 |
| Lane Group Flow (vph) | 245 | 337 | 160 | 679 | 280 | 22 | 240 | 687 | 941 |
| Turn Type | NA | pt+ov | Perm | NA | Prot | NA | Prot | NA | Prot |
| Protected Phases | 7 | 7 8 | | 7 | 1 | 6 | 5 | 2 | 8 |
| Permitted Phases | | | 7 | | | | | | |
| Minimum Split (s) | 37.0 | | 37.0 | 37.0 | 14.0 | 36.0 | 14.0 | 49.0 | 36.0 |
| Total Split (s) | 37.0 | | 37.0 | 37.0 | 26.0 | 49.0 | 26.0 | 49.0 | 38.0 |
| Total Split (%) | 24.7% | | 24.7% | 24.7% | 17.3% | 32.7% | 17.3% | 32.7% | 25.3% |
| Yellow Time (s) | 4.0 | | 4.0 | 4.0 | 4.0 | 4.0 | 4.0 | 4.0 | 4.0 |
| All-Red Time (s) | 4.0 | | 4.0 | 4.0 | 1.0 | 3.0 | 1.0 | 3.0 | 4.0 |
| Lost Time Adjust (s) | -1.0 | | -1.0 | -1.0 | -1.0 | -1.0 | -1.0 | -1.0 | -1.0 |
| Total Lost Time (s) | 7.0 | | 7.0 | 7.0 | 4.0 | 6.0 | 4.0 | 6.0 | 7.0 |
| Lead/Lag | Lead | | Lead | Lead | Lead | Lag | Lead | Lag | Lag |
| Lead-Lag Optimize? | | | | | | | | | |
| Act Effct Green (s) | 30.0 | 68.0 | 30.0 | 30.0 | 22.0 | 43.0 | 22.0 | 43.0 | 31.0 |
| Actuated g/C Ratio | 0.20 | 0.45 | 0.20 | 0.20 | 0.15 | 0.29 | 0.15 | 0.29 | 0.21 |
| v/c Ratio | 0.68 | 0.48 | 0.43 | 1.01 | 1.10 | 0.05 | 0.97 | 0.78 | 1.43 |
| Control Delay | 66.1 | 31.7 | 13.7 | 94.4 | 142.3 | 39.2 | 112.1 | 56.1 | 245.7 |
| Queue Delay | 0.0 | 0.0 | 0.0 | 0.0 | 0.0 | 0.0 | 0.0 | 0.0 | 0.0 |
| Total Delay | 66.1 | 31.7 | 13.7 | 94.4 | 142.3 | 39.2 | 112.1 | 56.1 | 245.7 |
| LOS | E | C | B | F | F | D | F | E | F |
| Approach Delay | 39.2 | | | 94.4 | | 134.8 | | 70.6 | 245.7 |
| Approach LOS | D | | | F | | F | | E | F |
| Queue Length 50th (m) | 68.3 | 69.3 | 3.7 | -107.5 | -93.9 | 4.8 | 72.0 | 98.4 | -194.7 |
| Queue Length 95th (m) | 98.6 | 98.1 | 24.6 | #149.6 | #151.9 | 11.9 | #126.4 | 122.2 | #235.4 |
| Internal Link Dist (m) | 112.3 | | | 207.4 | | 413.3 | | 402.3 | 600.3 |
| Turn Bay Length (m) | | 70.0 | 70.0 | | | | 80.0 | | |
| Base Capacity (vph) | 361 | 696 | 372 | 675 | 255 | 485 | 248 | 876 | 656 |
| Starvation Cap Reductn | 0 | 0 | 0 | 0 | 0 | 0 | 0 | 0 | 0 |
| Spillback Cap Reductn | 0 | 0 | 0 | 0 | 0 | 0 | 0 | 0 | 0 |
| Storage Cap Reductn | 0 | 0 | 0 | 0 | 0 | 0 | 0 | 0 | 0 |
| Reduced v/c Ratio | 0.68 | 0.48 | 0.43 | 1.01 | 1.10 | 0.05 | 0.97 | 0.78 | 1.43 |

Intersection Summary

Cycle Length: 150
 Actuated Cycle Length: 150
 Offset: 0 (0%), Referenced to phase 2:SBT and 6:NBT, Start of Green
 Natural Cycle: 140
 Control Type: Pretimed
 Maximum v/c Ratio: 1.43
 Intersection Signal Delay: 119.9
 Intersection Capacity Utilization 120.2%
 Analysis Period (min) 15
 - Volume exceeds capacity, queue is theoretically infinite.
 Queue shown is maximum after two cycles.
 # 95th percentile volume exceeds capacity, queue may be longer.
 Queue shown is maximum after two cycles.

Splits and Phases: 7: Robie & Bell & Quinpool/Cogswell

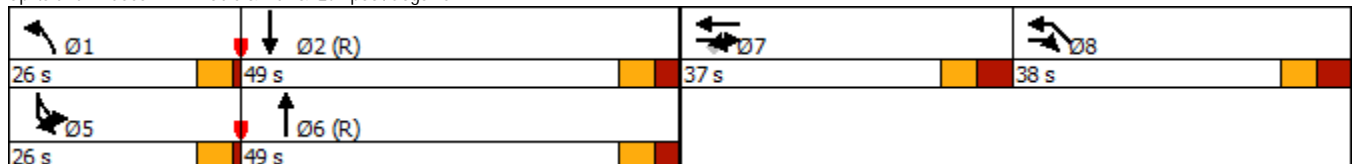

| Lane Group | EBL | EBT | WBL | WBT | WBR | NBL | NBT | SBL | SBT |
|------------------------|-------|-------|-------|-------|-------|-------|-------|-------|-------|
| Lane Configurations | | | | | | | | | |
| Traffic Volume (vph) | 60 | 135 | 15 | 340 | 120 | 160 | 19 | 105 | 607 |
| Future Volume (vph) | 60 | 135 | 15 | 340 | 120 | 160 | 19 | 105 | 607 |
| Lane Group Flow (vph) | 0 | 268 | 0 | 405 | 137 | 183 | 22 | 120 | 727 |
| Turn Type | Perm | NA | Perm | NA | Perm | Prot | NA | Prot | NA |
| Protected Phases | | 8 | | 4 | | 5 | 2 | 1 | 6 |
| Permitted Phases | 8 | | 4 | | 4 | | | | |
| Detector Phase | 8 | 8 | 4 | 4 | 4 | 5 | 2 | 1 | 6 |
| Switch Phase | | | | | | | | | |
| Minimum Initial (s) | 10.0 | 10.0 | 10.0 | 10.0 | 10.0 | 7.0 | 10.0 | 7.0 | 10.0 |
| Minimum Split (s) | 31.6 | 31.6 | 31.6 | 31.6 | 31.6 | 12.0 | 22.8 | 12.0 | 22.8 |
| Total Split (s) | 45.0 | 45.0 | 45.0 | 45.0 | 45.0 | 24.0 | 51.0 | 24.0 | 51.0 |
| Total Split (%) | 37.5% | 37.5% | 37.5% | 37.5% | 37.5% | 20.0% | 42.5% | 20.0% | 42.5% |
| Yellow Time (s) | 4.1 | 4.1 | 4.1 | 4.1 | 4.1 | 4.0 | 4.1 | 4.0 | 4.1 |
| All-Red Time (s) | 2.4 | 2.4 | 2.4 | 2.4 | 2.4 | 1.0 | 1.7 | 1.0 | 1.7 |
| Lost Time Adjust (s) | | 0.0 | | 0.0 | 0.0 | 0.0 | 0.0 | 0.0 | 0.0 |
| Total Lost Time (s) | | 6.5 | | 6.5 | 6.5 | 5.0 | 5.8 | 5.0 | 5.8 |
| Lead/Lag | | | | | | Lead | Lag | Lead | Lag |
| Lead-Lag Optimize? | | | | | | | | | |
| Recall Mode | Ped | Ped | Ped | Ped | Ped | None | C-Min | None | C-Min |
| Act Effct Green (s) | | 41.6 | | 41.6 | 41.6 | 17.5 | 47.2 | 13.9 | 43.6 |
| Actuated g/C Ratio | | 0.35 | | 0.35 | 0.35 | 0.15 | 0.39 | 0.12 | 0.36 |
| v/c Ratio | | 0.79 | | 0.66 | 0.27 | 0.81 | 0.03 | 0.63 | 0.62 |
| Control Delay | | 51.3 | | 38.5 | 11.1 | 83.2 | 9.6 | 64.6 | 35.1 |
| Queue Delay | | 0.0 | | 0.0 | 0.0 | 0.0 | 0.0 | 0.0 | 0.0 |
| Total Delay | | 51.3 | | 38.5 | 11.1 | 83.2 | 9.6 | 64.6 | 35.1 |
| LOS | | D | | D | B | F | A | E | D |
| Approach Delay | | 51.3 | | 31.6 | | | 75.3 | | 39.3 |
| Approach LOS | | D | | C | | | E | | D |
| Queue Length 50th (m) | | 51.8 | | 76.1 | 6.5 | 34.2 | 1.1 | 27.3 | 79.1 |
| Queue Length 95th (m) | | #98.5 | | 114.2 | 21.4 | m42.3 | m3.3 | 44.9 | 95.1 |
| Internal Link Dist (m) | | 189.8 | | 183.6 | | | 355.1 | | 413.3 |
| Turn Bay Length (m) | | | | | 40.0 | 50.0 | | 90.0 | |
| Base Capacity (vph) | | 348 | | 634 | 517 | 248 | 703 | 260 | 1279 |
| Starvation Cap Reductn | | 0 | | 0 | 0 | 0 | 0 | 0 | 0 |
| Spillback Cap Reductn | | 0 | | 0 | 0 | 0 | 0 | 0 | 0 |
| Storage Cap Reductn | | 0 | | 0 | 0 | 0 | 0 | 0 | 0 |
| Reduced v/c Ratio | | 0.77 | | 0.64 | 0.26 | 0.74 | 0.03 | 0.46 | 0.57 |

Intersection Summary

Cycle Length: 120
 Actuated Cycle Length: 120
 Offset: 47 (39%), Referenced to phase 2:NBT and 6:SBT, Start of Green
 Natural Cycle: 70
 Control Type: Actuated-Coordinated
 Maximum v/c Ratio: 0.81
 Intersection Signal Delay: 42.7
 Intersection Capacity Utilization 89.7%
 Analysis Period (min) 15
 # 95th percentile volume exceeds capacity, queue may be longer.
 Queue shown is maximum after two cycles.
 m Volume for 95th percentile queue is metered by upstream signal.

Splits and Phases: 8: Robie & Jubilee/Veterans Memorial

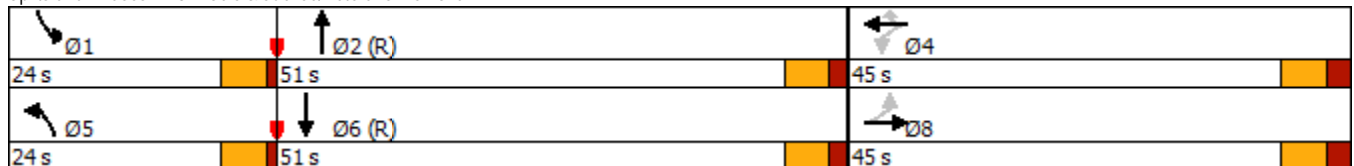

| Lane Group | EBL2 | EBT | WBL | WBT | NBL | NBT | SBU | SBL2 | SBL | SBT |
|------------------------|-------|-------|-------|--------|-------|-------|-------|-------|--------|-------|
| Lane Configurations | | | | | | | | | | |
| Traffic Volume (vph) | 55 | 135 | 40 | 315 | 160 | 13 | 18 | 0 | 112 | 375 |
| Future Volume (vph) | 55 | 135 | 40 | 315 | 160 | 13 | 18 | 0 | 112 | 375 |
| Lane Group Flow (vph) | 0 | 217 | 0 | 611 | 183 | 15 | 0 | 21 | 128 | 468 |
| Turn Type | Perm | NA | Perm | NA | Prot | NA | D.P+P | D.P+P | Prot | NA |
| Protected Phases | | 4 | | 4 | 5 | 2 | 9 | 9 | 1 | 6 |
| Permitted Phases | 4 | | 4 | | | | 2 | 2 | | |
| Detector Phase | 4 | 4 | 4 | 4 | 5 | 2 | 9 | 9 | 1 | 6 |
| Switch Phase | | | | | | | | | | |
| Minimum Initial (s) | 10.0 | 10.0 | 10.0 | 10.0 | 8.0 | 10.0 | 8.0 | 8.0 | 8.0 | 10.0 |
| Minimum Split (s) | 33.5 | 33.5 | 33.5 | 33.5 | 13.0 | 34.5 | 13.0 | 13.0 | 13.0 | 34.5 |
| Total Split (s) | 45.0 | 45.0 | 45.0 | 45.0 | 17.0 | 45.0 | 13.0 | 13.0 | 17.0 | 58.0 |
| Total Split (%) | 37.5% | 37.5% | 37.5% | 37.5% | 14.2% | 37.5% | 10.8% | 10.8% | 14.2% | 48.3% |
| Yellow Time (s) | 4.1 | 4.1 | 4.1 | 4.1 | 4.0 | 4.1 | 4.0 | 4.0 | 4.0 | 4.1 |
| All-Red Time (s) | 2.4 | 2.4 | 2.4 | 2.4 | 1.0 | 2.4 | 1.0 | 1.0 | 1.0 | 2.4 |
| Lost Time Adjust (s) | | 0.0 | | 0.0 | 0.0 | 0.0 | | 0.0 | 0.0 | 0.0 |
| Total Lost Time (s) | | 6.5 | | 6.5 | 5.0 | 6.5 | | 5.0 | 5.0 | 6.5 |
| Lead/Lag | | | | | Lead | | Lag | Lag | Lead | Lag |
| Lead-Lag Optimize? | | | | | | | | | | |
| Recall Mode | None | None | None | None | None | C-Max | None | None | None | C-Max |
| Act Effct Green (s) | | 36.5 | | 36.5 | 14.0 | 48.7 | | 53.4 | 11.6 | 51.5 |
| Actuated g/C Ratio | | 0.30 | | 0.30 | 0.12 | 0.41 | | 0.44 | 0.10 | 0.43 |
| v/c Ratio | | 0.76 | | 0.91 | 0.91 | 0.02 | | 0.03 | 0.78 | 0.65 |
| Control Delay | | 55.6 | | 58.3 | 95.9 | 26.4 | | 3.8 | 101.4 | 12.4 |
| Queue Delay | | 0.0 | | 0.0 | 0.0 | 0.0 | | 0.0 | 0.0 | 0.0 |
| Total Delay | | 55.6 | | 58.3 | 95.9 | 26.4 | | 3.8 | 101.4 | 12.4 |
| LOS | | E | | E | F | C | | A | F | B |
| Approach Delay | | 55.6 | | 58.3 | | 90.7 | | | | 30.6 |
| Approach LOS | | E | | E | | F | | | | C |
| Queue Length 50th (m) | | 45.0 | | 70.7 | -47.0 | 2.0 | | 0.4 | 32.4 | 10.6 |
| Queue Length 95th (m) | | #80.6 | | #102.0 | #92.1 | 7.4 | | m0.8 | m#60.3 | 16.3 |
| Internal Link Dist (m) | | 121.4 | | 124.9 | | 240.3 | | | | 355.1 |
| Turn Bay Length (m) | | | | | 60.0 | | | | | |
| Base Capacity (vph) | | 301 | | 710 | 202 | 631 | | 637 | 173 | 717 |
| Starvation Cap Reductn | | 0 | | 0 | 0 | 0 | | 0 | 0 | 0 |
| Spillback Cap Reductn | | 0 | | 0 | 0 | 0 | | 0 | 0 | 0 |
| Storage Cap Reductn | | 0 | | 0 | 0 | 0 | | 0 | 0 | 0 |
| Reduced v/c Ratio | | 0.72 | | 0.86 | 0.91 | 0.02 | | 0.03 | 0.74 | 0.65 |

Intersection Summary

Cycle Length: 120
 Actuated Cycle Length: 120
 Offset: 76 (63%), Referenced to phase 2:NBSB and 6:SBT, Start of Green
 Natural Cycle: 95
 Control Type: Actuated-Coordinated
 Maximum v/c Ratio: 0.91
 Intersection Signal Delay: 51.4
 Intersection Capacity Utilization 98.1%
 Analysis Period (min) 15
 ~ Volume exceeds capacity, queue is theoretically infinite.
 Queue shown is maximum after two cycles.
 # 95th percentile volume exceeds capacity, queue may be longer.
 Queue shown is maximum after two cycles.
 m Volume for 95th percentile queue is metered by upstream signal.

Splits and Phases: 9: Robie & Coburg/Spring Garden

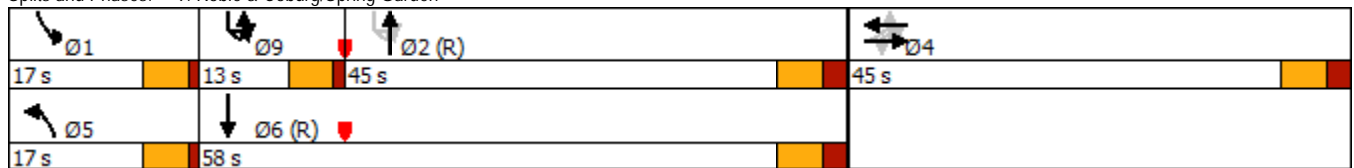

| Lane Group | EBL | EBT | WBL | WBT | WBR | NBL | NBT | SBL | SBT |
|------------------------|-------|-------|-------|-------|-------|-------|-------|-------|-------|
| Lane Configurations | | | | | | | | | |
| Traffic Volume (vph) | 45 | 100 | 25 | 145 | 225 | 30 | 11 | 132 | 263 |
| Future Volume (vph) | 45 | 100 | 25 | 145 | 225 | 30 | 11 | 132 | 263 |
| Lane Group Flow (vph) | 51 | 137 | 29 | 165 | 257 | 34 | 13 | 151 | 351 |
| Turn Type | Perm | NA | Perm | NA | pm+ov | pm+pt | NA | Prot | NA |
| Protected Phases | | 8 | | 4 | 5 | 1 | 6 | 5 | 2 |
| Permitted Phases | 8 | | 4 | | 4 | 6 | | | |
| Detector Phase | 8 | 8 | 4 | 4 | 5 | 1 | 6 | 5 | 2 |
| Switch Phase | | | | | | | | | |
| Minimum Initial (s) | 10.0 | 10.0 | 10.0 | 10.0 | 8.0 | 8.0 | 10.0 | 8.0 | 10.0 |
| Minimum Split (s) | 32.5 | 32.5 | 32.5 | 32.5 | 13.0 | 13.0 | 43.3 | 13.0 | 43.3 |
| Total Split (s) | 34.0 | 34.0 | 34.0 | 34.0 | 23.0 | 13.0 | 53.0 | 23.0 | 63.0 |
| Total Split (%) | 30.9% | 30.9% | 30.9% | 30.9% | 20.9% | 11.8% | 48.2% | 20.9% | 57.3% |
| Yellow Time (s) | 4.1 | 4.1 | 4.1 | 4.1 | 4.0 | 4.0 | 4.1 | 4.0 | 4.1 |
| All-Red Time (s) | 2.4 | 2.4 | 2.4 | 2.4 | 1.0 | 1.0 | 3.2 | 1.0 | 3.2 |
| Lost Time Adjust (s) | 0.0 | 0.0 | 0.0 | 0.0 | 0.0 | 0.0 | 0.0 | 0.0 | 0.0 |
| Total Lost Time (s) | 6.5 | 6.5 | 6.5 | 6.5 | 5.0 | 5.0 | 7.3 | 5.0 | 7.3 |
| Lead/Lag | | | | | | Lead | | | Lag |
| Lead-Lag Optimize? | | | | | | | | | |
| Recall Mode | Ped | Ped | Ped | Ped | None | None | C-Max | None | C-Max |
| Act Effct Green (s) | 26.0 | 26.0 | 26.0 | 26.0 | 42.2 | 60.8 | 50.5 | 14.7 | 62.4 |
| Actuated g/C Ratio | 0.24 | 0.24 | 0.24 | 0.24 | 0.38 | 0.55 | 0.46 | 0.13 | 0.57 |
| v/c Ratio | 0.38 | 0.36 | 0.12 | 0.43 | 0.54 | 0.06 | 0.02 | 0.66 | 0.42 |
| Control Delay | 44.9 | 36.0 | 34.8 | 39.8 | 7.7 | 8.0 | 20.1 | 58.5 | 16.3 |
| Queue Delay | 0.0 | 0.0 | 0.0 | 0.0 | 0.0 | 0.0 | 0.0 | 0.0 | 0.0 |
| Total Delay | 44.9 | 36.0 | 34.8 | 39.8 | 7.7 | 8.0 | 20.1 | 58.5 | 16.3 |
| LOS | D | D | C | D | A | A | C | E | B |
| Approach Delay | | 38.4 | | 21.2 | | | 11.3 | | 29.0 |
| Approach LOS | | D | | C | | | B | | C |
| Queue Length 50th (m) | 9.2 | 23.0 | 4.9 | 30.2 | 0.0 | 2.7 | 1.7 | 31.1 | 44.1 |
| Queue Length 95th (m) | 21.4 | 40.8 | 12.8 | 50.3 | 13.1 | m5.4 | m5.0 | 49.8 | 67.7 |
| Internal Link Dist (m) | | 178.0 | | 171.4 | | | 167.5 | | 240.3 |
| Turn Bay Length (m) | 15.0 | | 15.0 | | 60.0 | 60.0 | | 60.0 | |
| Base Capacity (vph) | 143 | 397 | 252 | 406 | 509 | 561 | 685 | 285 | 829 |
| Starvation Cap Reductn | 0 | 0 | 0 | 0 | 0 | 0 | 0 | 0 | 0 |
| Spillback Cap Reductn | 0 | 0 | 0 | 0 | 0 | 0 | 0 | 0 | 0 |
| Storage Cap Reductn | 0 | 0 | 0 | 0 | 0 | 0 | 0 | 0 | 0 |
| Reduced v/c Ratio | 0.36 | 0.35 | 0.12 | 0.41 | 0.50 | 0.06 | 0.02 | 0.53 | 0.42 |

Intersection Summary

Cycle Length: 110
 Actuated Cycle Length: 110
 Offset: 88 (80%), Referenced to phase 2:SBT and 6:NBTL, Start of Green
 Natural Cycle: 90
 Control Type: Actuated-Coordinated
 Maximum v/c Ratio: 0.66
 Intersection Signal Delay: 26.8
 Intersection Capacity Utilization 78.6%
 Analysis Period (min) 15
 m Volume for 95th percentile queue is metered by upstream signal.

Splits and Phases: 10: Robie & University

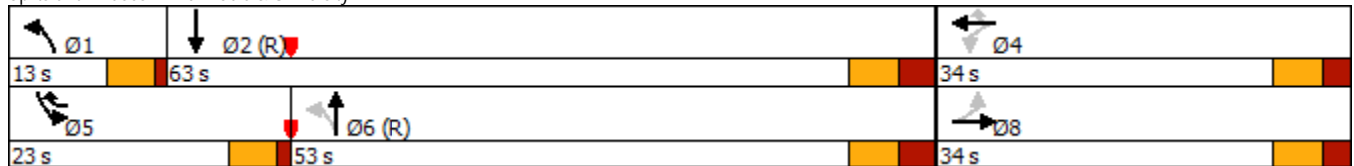

| Lane Group | EBL | EBT | WBL | WBT | WBR | NBL | NBT | NBR | SBL | SBT |
|------------------------|-------|-------|-------|-------|-------|-------|-------|--------|-------|-------|
| Lane Configurations | | | | | | | | | | |
| Traffic Volume (vph) | 55 | 205 | 20 | 345 | 245 | 3 | 4 | 42 | 91 | 195 |
| Future Volume (vph) | 55 | 205 | 20 | 345 | 245 | 3 | 4 | 42 | 91 | 195 |
| Lane Group Flow (vph) | 0 | 320 | 0 | 417 | 280 | 0 | 8 | 48 | 104 | 277 |
| Turn Type | Perm | NA | Perm | NA | Perm | Perm | NA | custom | Prot | NA |
| Protected Phases | | 4 | | 4 | | | 2 | 5! | 1! | 6 |
| Permitted Phases | 4 | | 4 | | 4 | 2 | | | | |
| Detector Phase | 4 | 4 | 4 | 4 | 4 | 2 | 2 | 5 | 1 | 6 |
| Switch Phase | | | | | | | | | | |
| Minimum Initial (s) | 10.0 | 10.0 | 10.0 | 10.0 | 10.0 | 10.0 | 10.0 | 8.0 | 8.0 | 10.0 |
| Minimum Split (s) | 47.8 | 47.8 | 47.8 | 47.8 | 47.8 | 24.7 | 24.7 | 13.0 | 13.0 | 24.7 |
| Total Split (s) | 55.0 | 55.0 | 55.0 | 55.0 | 55.0 | 42.0 | 42.0 | 13.0 | 13.0 | 42.0 |
| Total Split (%) | 50.0% | 50.0% | 50.0% | 50.0% | 50.0% | 38.2% | 38.2% | 11.8% | 11.8% | 38.2% |
| Yellow Time (s) | 4.1 | 4.1 | 4.1 | 4.1 | 4.1 | 4.1 | 4.1 | 4.0 | 4.0 | 4.1 |
| All-Red Time (s) | 2.7 | 2.7 | 2.7 | 2.7 | 2.7 | 1.6 | 1.6 | 1.0 | 1.0 | 1.6 |
| Lost Time Adjust (s) | | 0.0 | | 0.0 | 0.0 | | 0.0 | 0.0 | 0.0 | 0.0 |
| Total Lost Time (s) | | 6.8 | | 6.8 | 6.8 | | 5.7 | 5.0 | 5.0 | 5.7 |
| Lead/Lag | | | | | | Lag | Lag | Lead | Lead | Lag |
| Lead-Lag Optimize? | | | | | | | | | | |
| Recall Mode | Ped | Ped | Ped | Ped | Ped | C-Min | C-Min | Min | None | C-Min |
| Act Effct Green (s) | | 43.2 | | 43.2 | 43.2 | | 37.2 | 8.0 | 12.1 | 41.3 |
| Actuated g/C Ratio | | 0.39 | | 0.39 | 0.39 | | 0.34 | 0.07 | 0.11 | 0.38 |
| v/c Ratio | | 0.75 | | 0.61 | 0.39 | | 0.02 | 0.25 | 0.59 | 0.52 |
| Control Delay | | 40.3 | | 30.7 | 4.0 | | 26.0 | 4.2 | 73.3 | 22.2 |
| Queue Delay | | 0.0 | | 0.0 | 0.0 | | 0.0 | 0.0 | 0.0 | 0.0 |
| Total Delay | | 40.3 | | 30.7 | 4.0 | | 26.0 | 4.2 | 73.3 | 22.2 |
| LOS | | D | | C | A | | C | A | E | C |
| Approach Delay | | 40.3 | | 20.0 | | | 7.3 | | | 36.1 |
| Approach LOS | | D | | B | | | A | | | D |
| Queue Length 50th (m) | | 59.5 | | 72.9 | 0.0 | | 1.2 | 0.0 | 23.8 | 19.0 |
| Queue Length 95th (m) | | 84.8 | | 92.7 | 14.3 | | 4.7 | 1.6 | #53.5 | 78.7 |
| Internal Link Dist (m) | | 115.5 | | 183.6 | | | 422.3 | | | 167.5 |
| Turn Bay Length (m) | | | | | 50.0 | | | | 60.0 | |
| Base Capacity (vph) | | 477 | | 765 | 769 | | 504 | 189 | 175 | 535 |
| Starvation Cap Reductn | | 0 | | 0 | 0 | | 0 | 0 | 0 | 0 |
| Spillback Cap Reductn | | 0 | | 0 | 0 | | 0 | 0 | 0 | 0 |
| Storage Cap Reductn | | 0 | | 0 | 0 | | 0 | 0 | 0 | 0 |
| Reduced v/c Ratio | | 0.67 | | 0.55 | 0.36 | | 0.02 | 0.25 | 0.59 | 0.52 |

Intersection Summary

Cycle Length: 110
 Actuated Cycle Length: 110
 Offset: 108 (98%), Referenced to phase 2:NBT and 6:SBT, Start of Green
 Natural Cycle: 90
 Control Type: Actuated-Coordinated
 Maximum v/c Ratio: 0.75
 Intersection Signal Delay: 28.2
 Intersection Capacity Utilization 100.3%
 Analysis Period (min) 15
 # 95th percentile volume exceeds capacity, queue may be longer.
 Queue shown is maximum after two cycles.
 ! Phase conflict between lane groups.

Splits and Phases: 11: Robie & South

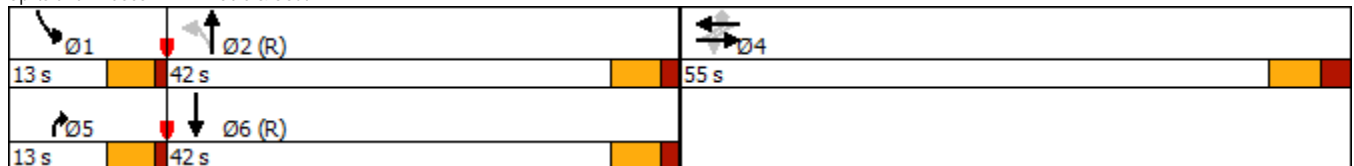

| Lane Group | EBL | EBT | WBL | WBT | WBR | NBL | NBT | SBL | SBT |
|------------------------|-------|-------|-------|-------|--------|-------|-------|-------|-------|
| Lane Configurations | | | | | | | | | |
| Traffic Volume (vph) | 20 | 235 | 80 | 275 | 275 | 30 | 125 | 175 | 70 |
| Future Volume (vph) | 20 | 235 | 80 | 275 | 275 | 30 | 125 | 175 | 70 |
| Lane Group Flow (vph) | 0 | 320 | 0 | 405 | 314 | 0 | 268 | 200 | 97 |
| Turn Type | Perm | NA | Perm | NA | custom | Perm | NA | pm+pt | NA |
| Protected Phases | | 8 | | 4 | | | 6 | 5 | 2 |
| Permitted Phases | 8 | | 4 | | 4 5 | 6 | | 2 | |
| Detector Phase | 8 | 8 | 4 | 4 | 4 5 | 6 | 6 | 5 | 2 |
| Switch Phase | | | | | | | | | |
| Minimum Initial (s) | 10.0 | 10.0 | 10.0 | 10.0 | | 10.0 | 10.0 | 8.0 | 10.0 |
| Minimum Split (s) | 31.7 | 31.7 | 31.7 | 31.7 | | 23.1 | 23.1 | 11.0 | 23.1 |
| Total Split (s) | 40.0 | 40.0 | 40.0 | 40.0 | | 39.0 | 39.0 | 11.0 | 50.0 |
| Total Split (%) | 44.4% | 44.4% | 44.4% | 44.4% | | 43.3% | 43.3% | 12.2% | 55.6% |
| Yellow Time (s) | 4.1 | 4.1 | 4.1 | 4.1 | | 4.1 | 4.1 | 3.0 | 4.1 |
| All-Red Time (s) | 2.6 | 2.6 | 2.6 | 2.6 | | 2.0 | 2.0 | 0.0 | 2.0 |
| Lost Time Adjust (s) | | 0.0 | | 0.0 | | | 0.0 | 0.0 | 0.0 |
| Total Lost Time (s) | | 6.7 | | 6.7 | | | 6.1 | 3.0 | 6.1 |
| Lead/Lag | | | | | | Lag | Lag | Lead | |
| Lead-Lag Optimize? | | | | | | | | | |
| Recall Mode | Ped | Ped | Max | Max | | C-Min | C-Min | None | C-Min |
| Act Effct Green (s) | | 44.9 | | 44.9 | 55.9 | | 21.3 | 35.4 | 32.3 |
| Actuated g/C Ratio | | 0.50 | | 0.50 | 0.62 | | 0.24 | 0.39 | 0.36 |
| v/c Ratio | | 0.37 | | 0.56 | 0.31 | | 0.78 | 0.60 | 0.18 |
| Control Delay | | 16.9 | | 21.4 | 2.2 | | 42.8 | 25.4 | 15.0 |
| Queue Delay | | 0.0 | | 0.0 | 0.0 | | 0.0 | 0.0 | 0.0 |
| Total Delay | | 16.9 | | 21.4 | 2.2 | | 42.8 | 25.4 | 15.0 |
| LOS | | B | | C | A | | D | C | B |
| Approach Delay | | 16.9 | | 13.0 | | | 42.8 | | 22.0 |
| Approach LOS | | B | | B | | | D | | C |
| Queue Length 50th (m) | | 31.9 | | 46.6 | 0.0 | | 38.4 | 23.3 | 9.2 |
| Queue Length 95th (m) | | 61.8 | | 90.5 | 11.5 | | 57.6 | 32.4 | 16.5 |
| Internal Link Dist (m) | | 113.9 | | 142.4 | | | 118.8 | | 422.3 |
| Turn Bay Length (m) | | | | | 50.0 | | | 60.0 | |
| Base Capacity (vph) | | 854 | | 722 | 1002 | | 515 | 336 | 726 |
| Starvation Cap Reductn | | 0 | | 0 | 0 | | 0 | 0 | 0 |
| Spillback Cap Reductn | | 0 | | 0 | 0 | | 0 | 0 | 0 |
| Storage Cap Reductn | | 0 | | 0 | 0 | | 0 | 0 | 0 |
| Reduced v/c Ratio | | 0.37 | | 0.56 | 0.31 | | 0.52 | 0.60 | 0.13 |

Intersection Summary

Cycle Length: 90
 Actuated Cycle Length: 90
 Offset: 0 (0%), Referenced to phase 2:SBTL and 6:NBTL, Start of Green
 Natural Cycle: 70
 Control Type: Actuated-Coordinated
 Maximum v/c Ratio: 0.78
 Intersection Signal Delay: 20.5
 Intersection Capacity Utilization 87.2%
 Analysis Period (min) 15

Intersection LOS: C
 ICU Level of Service E

Splits and Phases: 12: Robie & Inglis

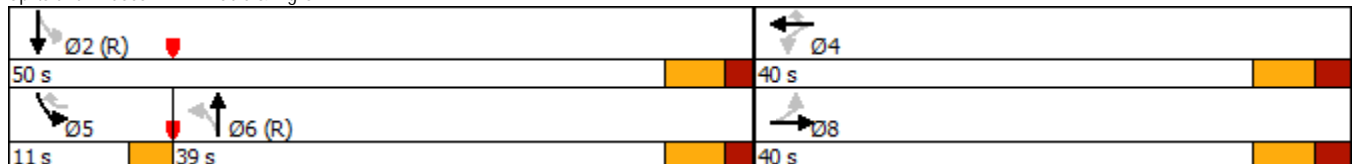

| Lane Group | EBL | EBT | WBL | WBT | WBR | NBL | NBT | SBL | SBT |
|------------------------|-------|-------|-------|--------|-------|-------|--------|-------|-------|
| Lane Configurations | | | | | | | | | |
| Traffic Volume (vph) | 190 | 195 | 15 | 470 | 125 | 30 | 747 | 20 | 11 |
| Future Volume (vph) | 190 | 195 | 15 | 470 | 125 | 30 | 747 | 20 | 11 |
| Lane Group Flow (vph) | 217 | 291 | 0 | 553 | 143 | 34 | 864 | 23 | 13 |
| Turn Type | pm+pt | NA | Perm | NA | Perm | Prot | NA | Prot | NA |
| Protected Phases | 3 | 8 | | 4 | | 1 | 2 | 1 | 2 |
| Permitted Phases | 8 | | 4 | | 4 | | | | |
| Detector Phase | 3 | 8 | 4 | 4 | 4 | 1 | 2 | 1 | 2 |
| Switch Phase | | | | | | | | | |
| Minimum Initial (s) | 7.0 | 10.0 | 10.0 | 10.0 | 10.0 | 8.0 | 10.0 | 8.0 | 10.0 |
| Minimum Split (s) | 11.0 | 50.0 | 37.0 | 37.0 | 37.0 | 13.0 | 40.0 | 13.0 | 40.0 |
| Total Split (s) | 14.0 | 52.0 | 38.0 | 38.0 | 38.0 | 13.0 | 55.0 | 13.0 | 55.0 |
| Total Split (%) | 11.7% | 43.3% | 31.7% | 31.7% | 31.7% | 10.8% | 45.8% | 10.8% | 45.8% |
| Yellow Time (s) | 4.0 | 4.1 | 4.1 | 4.1 | 4.1 | 4.0 | 4.1 | 4.0 | 4.1 |
| All-Red Time (s) | 0.0 | 2.1 | 2.1 | 2.1 | 2.1 | 1.0 | 1.7 | 1.0 | 1.7 |
| Lost Time Adjust (s) | 0.0 | 0.0 | | 0.0 | 0.0 | 0.0 | 0.0 | 0.0 | 0.0 |
| Total Lost Time (s) | 4.0 | 6.2 | | 6.2 | 6.2 | 5.0 | 5.8 | 5.0 | 5.8 |
| Lead/Lag | Lead | | Lag | Lag | Lag | Lead | Lag | Lead | Lag |
| Lead-Lag Optimize? | | | | | | | | | |
| Recall Mode | None | None | None | None | None | None | C-Min | None | C-Min |
| Act Effct Green (s) | 48.0 | 45.8 | | 31.8 | 31.8 | 8.0 | 51.8 | 8.0 | 51.8 |
| Actuated g/C Ratio | 0.40 | 0.38 | | 0.26 | 0.26 | 0.07 | 0.43 | 0.07 | 0.43 |
| v/c Ratio | 1.04 | 0.44 | | 0.97 | 0.32 | 0.29 | 1.14 | 0.20 | 0.02 |
| Control Delay | 101.8 | 28.6 | | 75.5 | 13.0 | 60.1 | 112.9 | 73.0 | 10.2 |
| Queue Delay | 0.0 | 0.0 | | 0.0 | 0.0 | 0.0 | 0.0 | 0.0 | 0.0 |
| Total Delay | 101.8 | 28.6 | | 75.5 | 13.0 | 60.1 | 112.9 | 73.0 | 10.2 |
| LOS | F | C | | E | B | E | F | E | B |
| Approach Delay | | 59.9 | | 62.7 | | | 110.9 | | 50.3 |
| Approach LOS | | E | | E | | | F | | D |
| Queue Length 50th (m) | -38.8 | 47.6 | | 129.3 | 6.4 | 7.8 | -248.5 | 5.8 | 0.8 |
| Queue Length 95th (m) | #87.7 | 72.4 | | #198.2 | 23.1 | 18.3 | #324.2 | m9.6 | m1.6 |
| Internal Link Dist (m) | | 253.6 | | 204.8 | | | 402.8 | | 360.9 |
| Turn Bay Length (m) | 80.0 | | | | 50.0 | 25.0 | | 180.0 | |
| Base Capacity (vph) | 209 | 663 | | 569 | 447 | 117 | 756 | 115 | 787 |
| Starvation Cap Reductn | 0 | 0 | | 0 | 0 | 0 | 0 | 0 | 0 |
| Spillback Cap Reductn | 0 | 0 | | 0 | 0 | 0 | 0 | 0 | 0 |
| Storage Cap Reductn | 0 | 0 | | 0 | 0 | 0 | 0 | 0 | 0 |
| Reduced v/c Ratio | 1.04 | 0.44 | | 0.97 | 0.32 | 0.29 | 1.14 | 0.20 | 0.02 |

Intersection Summary

Cycle Length: 120
 Actuated Cycle Length: 120
 Offset: 76 (63%), Referenced to phase 2:NBSB and 6:, Start of Green
 Natural Cycle: 125
 Control Type: Actuated-Coordinated
 Maximum v/c Ratio: 1.14
 Intersection Signal Delay: 82.0
 Intersection Capacity Utilization 117.0%
 Analysis Period (min) 15
 ~ Volume exceeds capacity, queue is theoretically infinite.
 Queue shown is maximum after two cycles.
 # 95th percentile volume exceeds capacity, queue may be longer.
 Queue shown is maximum after two cycles.
 m Volume for 95th percentile queue is metered by upstream signal.

Splits and Phases: 4: Robie & Almon

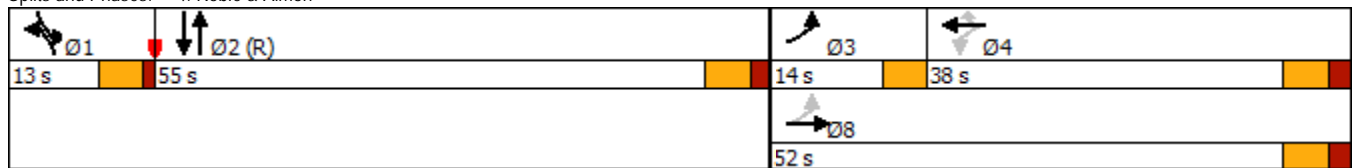

| Lane Group | EBT | WBT | NBT | NBR | SBT |
|------------------------|-------|--------|-------|--------|-------|
| Lane Configurations | | | | | |
| Traffic Volume (vph) | 345 | 445 | 657 | 375 | 11 |
| Future Volume (vph) | 345 | 445 | 657 | 375 | 11 |
| Lane Group Flow (vph) | 423 | 531 | 750 | 428 | 13 |
| Turn Type | NA | NA | NA | Perm | NA |
| Protected Phases | 8 | 4 | 2 | | 2 |
| Permitted Phases | | | | 2 | |
| Detector Phase | 8 | 4 | 2 | 2 | 2 |
| Switch Phase | | | | | |
| Minimum Initial (s) | 10.0 | 10.0 | 10.0 | 10.0 | 10.0 |
| Minimum Split (s) | 23.7 | 23.7 | 54.0 | 54.0 | 54.0 |
| Total Split (s) | 36.0 | 36.0 | 54.0 | 54.0 | 54.0 |
| Total Split (%) | 40.0% | 40.0% | 60.0% | 60.0% | 60.0% |
| Yellow Time (s) | 4.1 | 4.1 | 4.1 | 4.1 | 4.1 |
| All-Red Time (s) | 1.6 | 1.6 | 1.5 | 1.5 | 1.5 |
| Lost Time Adjust (s) | 0.0 | 0.0 | 0.0 | 0.0 | 0.0 |
| Total Lost Time (s) | 5.7 | 5.7 | 5.6 | 5.6 | 5.6 |
| Lead/Lag | | | | | |
| Lead-Lag Optimize? | | | | | |
| Recall Mode | Ped | Ped | C-Max | C-Max | C-Max |
| Act Effct Green (s) | 28.6 | 28.6 | 50.1 | 50.1 | 50.1 |
| Actuated g/C Ratio | 0.32 | 0.32 | 0.56 | 0.56 | 0.56 |
| v/c Ratio | 0.76 | 0.91 | 0.77 | 0.98 | 0.01 |
| Control Delay | 36.6 | 50.4 | 23.1 | 55.1 | 9.8 |
| Queue Delay | 0.0 | 0.0 | 0.0 | 0.0 | 0.0 |
| Total Delay | 36.6 | 50.4 | 23.1 | 55.1 | 9.8 |
| LOS | D | D | C | E | A |
| Approach Delay | 36.6 | 50.4 | 34.7 | | 9.8 |
| Approach LOS | D | D | C | | A |
| Queue Length 50th (m) | 62.5 | 84.2 | 99.1 | ~54.7 | 1.0 |
| Queue Length 95th (m) | 95.6 | #139.6 | 150.8 | #121.9 | 3.6 |
| Internal Link Dist (m) | 171.5 | 198.8 | 446.6 | | 402.8 |
| Turn Bay Length (m) | | | | 50.0 | |
| Base Capacity (vph) | 594 | 620 | 970 | 438 | 995 |
| Starvation Cap Reductn | 0 | 0 | 0 | 0 | 0 |
| Spillback Cap Reductn | 0 | 0 | 0 | 0 | 0 |
| Storage Cap Reductn | 0 | 0 | 0 | 0 | 0 |
| Reduced v/c Ratio | 0.71 | 0.86 | 0.77 | 0.98 | 0.01 |

Intersection Summary

Cycle Length: 90
 Actuated Cycle Length: 90
 Offset: 0 (0%), Referenced to phase 2:NBSB, Start of Green
 Natural Cycle: 90
 Control Type: Actuated-Coordinated
 Maximum v/c Ratio: 0.98
 Intersection Signal Delay: 38.8
 Intersection Capacity Utilization 81.6%
 Analysis Period (min) 15
 ~ Volume exceeds capacity, queue is theoretically infinite.
 Queue shown is maximum after two cycles.
 # 95th percentile volume exceeds capacity, queue may be longer.
 Queue shown is maximum after two cycles.

Splits and Phases: 5: Robie & North

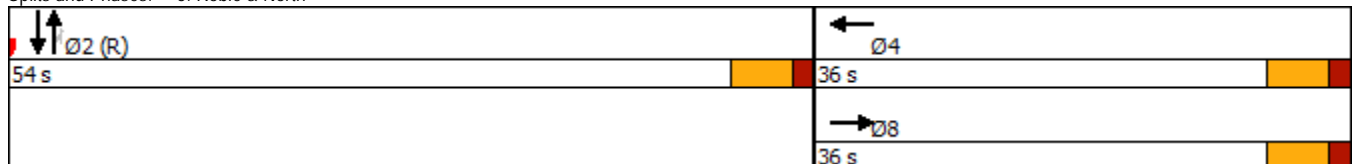

| Lane Group | EBL | EBT | WBL2 | WBT | WBR | SBL2 | SBL | NWL2 | NWL | NWR |
|------------------------|-------|--------|-------|--------|-------|-------|-------|-------|-------|--------|
| Lane Configurations | | | | | | | | | | |
| Traffic Volume (vph) | 20 | 300 | 65 | 475 | 75 | 55 | 11 | 21 | 42 | 747 |
| Future Volume (vph) | 20 | 300 | 65 | 475 | 75 | 55 | 11 | 21 | 42 | 747 |
| Lane Group Flow (vph) | 23 | 410 | 74 | 542 | 86 | 63 | 13 | 24 | 48 | 921 |
| Turn Type | Perm | NA | Perm | NA | Perm | Prot | Prot | pm+pt | Prot | Prot |
| Protected Phases | | 8 | | 4 | | 1 | 6 | 9 | 5 | 2 |
| Permitted Phases | 8 | | 4 | | 4 | | | 2 | | |
| Detector Phase | 8 | 8 | 4 | 4 | 4 | 1 | 6 | 9 | 5 | 2 |
| Switch Phase | | | | | | | | | | |
| Minimum Initial (s) | 10.0 | 10.0 | 10.0 | 10.0 | 10.0 | 8.0 | 8.0 | 8.0 | 8.0 | 10.0 |
| Minimum Split (s) | 39.1 | 39.1 | 39.1 | 39.1 | 39.1 | 13.0 | 24.0 | 13.0 | 13.0 | 37.9 |
| Total Split (s) | 43.0 | 43.0 | 43.0 | 43.0 | 43.0 | 14.0 | 50.0 | 13.0 | 14.0 | 63.0 |
| Total Split (%) | 35.8% | 35.8% | 35.8% | 35.8% | 35.8% | 11.7% | 41.7% | 10.8% | 11.7% | 52.5% |
| Yellow Time (s) | 4.1 | 4.1 | 4.1 | 4.1 | 4.1 | 4.0 | 4.0 | 4.0 | 4.0 | 4.1 |
| All-Red Time (s) | 3.0 | 3.0 | 3.0 | 3.0 | 3.0 | 1.0 | 2.0 | 0.0 | 1.0 | 2.0 |
| Lost Time Adjust (s) | 0.0 | 0.0 | 0.0 | 0.0 | 0.0 | 0.0 | 0.0 | 0.0 | 0.0 | 0.0 |
| Total Lost Time (s) | 7.1 | 7.1 | 7.1 | 7.1 | 7.1 | 5.0 | 6.0 | 4.0 | 5.0 | 6.1 |
| Lead/Lag | | | | | | Lead | | Lag | Lead | Lag |
| Lead-Lag Optimize? | | | | | | | | | | |
| Recall Mode | Ped | Ped | Ped | Ped | Ped | None | C-Max | None | None | C-Max |
| Act Effct Green (s) | 35.9 | 35.9 | 35.9 | 35.9 | 35.9 | 8.6 | 52.8 | 62.0 | 8.6 | 59.9 |
| Actuated g/C Ratio | 0.30 | 0.30 | 0.30 | 0.30 | 0.30 | 0.07 | 0.44 | 0.52 | 0.07 | 0.50 |
| v/c Ratio | 0.48 | 0.96 | 0.55 | 0.99 | 0.18 | 0.51 | 0.02 | 0.03 | 0.40 | 1.13 |
| Control Delay | 70.5 | 76.2 | 53.2 | 79.6 | 4.0 | 68.2 | 23.5 | 15.9 | 63.7 | 101.6 |
| Queue Delay | 0.0 | 0.0 | 0.0 | 0.0 | 0.0 | 0.0 | 0.0 | 0.0 | 0.0 | 0.0 |
| Total Delay | 70.5 | 76.2 | 53.2 | 79.6 | 4.0 | 68.2 | 23.5 | 15.9 | 63.7 | 101.6 |
| LOS | E | E | D | E | A | E | C | B | E | F |
| Approach Delay | | 75.9 | | 67.6 | | | | | 97.7 | |
| Approach LOS | | E | | E | | | | | F | |
| Queue Length 50th (m) | 4.4 | 94.7 | 14.6 | 127.2 | 0.0 | 14.5 | 1.9 | 2.8 | 11.0 | -250.6 |
| Queue Length 95th (m) | #17.0 | #156.2 | #33.2 | #198.0 | 7.3 | 29.1 | 6.1 | 7.4 | 23.3 | #327.3 |
| Internal Link Dist (m) | | 72.7 | | 213.1 | | | | | 210.2 | |
| Turn Bay Length (m) | 50.0 | | | | 50.0 | 40.0 | 40.0 | 40.0 | 40.0 | |
| Base Capacity (vph) | 48 | 428 | 134 | 545 | 468 | 129 | 762 | 695 | 125 | 815 |
| Starvation Cap Reductn | 0 | 0 | 0 | 0 | 0 | 0 | 0 | 0 | 0 | 0 |
| Spillback Cap Reductn | 0 | 0 | 0 | 0 | 0 | 0 | 0 | 0 | 0 | 0 |
| Storage Cap Reductn | 0 | 0 | 0 | 0 | 0 | 0 | 0 | 0 | 0 | 0 |
| Reduced v/c Ratio | 0.48 | 0.96 | 0.55 | 0.99 | 0.18 | 0.49 | 0.02 | 0.03 | 0.38 | 1.13 |

Intersection Summary

Cycle Length: 120
 Actuated Cycle Length: 120
 Offset: 0 (0%), Referenced to phase 2:NWL and 6:SBL, Start of Green
 Natural Cycle: 120
 Control Type: Actuated-Coordinated
 Maximum v/c Ratio: 1.13
 Intersection Signal Delay: 82.6
 Intersection Capacity Utilization 111.1%
 Analysis Period (min) 15
 ~ Volume exceeds capacity, queue is theoretically infinite.
 Queue shown is maximum after two cycles.
 # 95th percentile volume exceeds capacity, queue may be longer.
 Queue shown is maximum after two cycles.

Intersection LOS: F
 ICU Level of Service H

Splits and Phases: 6: Robie & Cunard

| | | |
|------|------|------|
| | | |
| 14 s | 63 s | 43 s |
| | | |
| 14 s | 13 s | 50 s |
| | | |
| | | 43 s |

| Lane Group | EBT | EBR | EBR2 | WBT | NBL | NBT | SBL | SBT | NWL |
|------------------------|-------|-------|-------|--------|--------|--------|--------|-------|--------|
| Lane Configurations | | | | | | | | | |
| Traffic Volume (vph) | 215 | 295 | 140 | 535 | 245 | 756 | 140 | 18 | 625 |
| Future Volume (vph) | 215 | 295 | 140 | 535 | 245 | 756 | 140 | 18 | 625 |
| Lane Group Flow (vph) | 245 | 337 | 160 | 679 | 280 | 931 | 240 | 21 | 941 |
| Turn Type | NA | pt+ov | Perm | NA | Prot | NA | Prot | NA | Prot |
| Protected Phases | 7 | 7 8 | | 7 | 1 | 6 | 5 | 2 | 8 |
| Permitted Phases | | | 7 | | | | | | |
| Minimum Split (s) | 37.0 | | 37.0 | 37.0 | 14.0 | 36.0 | 14.0 | 49.0 | 36.0 |
| Total Split (s) | 37.0 | | 37.0 | 37.0 | 26.0 | 49.0 | 26.0 | 49.0 | 38.0 |
| Total Split (%) | 24.7% | | 24.7% | 24.7% | 17.3% | 32.7% | 17.3% | 32.7% | 25.3% |
| Yellow Time (s) | 4.0 | | 4.0 | 4.0 | 4.0 | 4.0 | 4.0 | 4.0 | 4.0 |
| All-Red Time (s) | 4.0 | | 4.0 | 4.0 | 1.0 | 3.0 | 1.0 | 3.0 | 4.0 |
| Lost Time Adjust (s) | -1.0 | | -1.0 | -1.0 | -1.0 | -1.0 | -1.0 | -1.0 | -1.0 |
| Total Lost Time (s) | 7.0 | | 7.0 | 7.0 | 4.0 | 6.0 | 4.0 | 6.0 | 7.0 |
| Lead/Lag | Lead | | Lead | Lead | Lead | Lag | Lead | Lag | Lag |
| Lead-Lag Optimize? | | | | | | | | | |
| Act Effct Green (s) | 30.0 | 68.0 | 30.0 | 30.0 | 22.0 | 43.0 | 22.0 | 43.0 | 31.0 |
| Actuated g/C Ratio | 0.20 | 0.45 | 0.20 | 0.20 | 0.15 | 0.29 | 0.15 | 0.29 | 0.21 |
| v/c Ratio | 0.68 | 0.48 | 0.43 | 1.00 | 1.10 | 1.01 | 0.97 | 0.05 | 1.43 |
| Control Delay | 66.1 | 31.7 | 13.7 | 93.4 | 142.3 | 85.5 | 112.1 | 39.3 | 245.7 |
| Queue Delay | 0.0 | 0.0 | 0.0 | 0.0 | 0.0 | 0.0 | 0.0 | 0.0 | 0.0 |
| Total Delay | 66.1 | 31.7 | 13.7 | 93.4 | 142.3 | 85.5 | 112.1 | 39.3 | 245.7 |
| LOS | E | C | B | F | F | F | F | D | F |
| Approach Delay | 39.2 | | | 93.4 | | 98.7 | | 106.2 | 245.7 |
| Approach LOS | D | | | F | | F | | F | F |
| Queue Length 50th (m) | 68.3 | 69.3 | 3.7 | -106.8 | -93.9 | -150.2 | 72.0 | 4.6 | -194.7 |
| Queue Length 95th (m) | 98.6 | 98.1 | 24.6 | #149.2 | #151.9 | #194.6 | #126.4 | 11.5 | #235.4 |
| Internal Link Dist (m) | 112.3 | | | 207.4 | | 413.3 | | 168.1 | 600.3 |
| Turn Bay Length (m) | | 70.0 | 70.0 | | 100.0 | | | | |
| Base Capacity (vph) | 361 | 696 | 372 | 678 | 255 | 918 | 248 | 427 | 656 |
| Starvation Cap Reductn | 0 | 0 | 0 | 0 | 0 | 0 | 0 | 0 | 0 |
| Spillback Cap Reductn | 0 | 0 | 0 | 0 | 0 | 0 | 0 | 0 | 0 |
| Storage Cap Reductn | 0 | 0 | 0 | 0 | 0 | 0 | 0 | 0 | 0 |
| Reduced v/c Ratio | 0.68 | 0.48 | 0.43 | 1.00 | 1.10 | 1.01 | 0.97 | 0.05 | 1.43 |

Intersection Summary

Cycle Length: 150
 Actuated Cycle Length: 150
 Offset: 0 (0%), Referenced to phase 2:SBT and 6:NBT, Start of Green
 Natural Cycle: 140
 Control Type: Pretimed
 Maximum v/c Ratio: 1.43
 Intersection Signal Delay: 122.8
 Intersection Capacity Utilization 120.2%
 Analysis Period (min) 15
 - Volume exceeds capacity, queue is theoretically infinite.
 Queue shown is maximum after two cycles.
 # 95th percentile volume exceeds capacity, queue may be longer.
 Queue shown is maximum after two cycles.

Intersection LOS: F
 ICU Level of Service H

Splits and Phases: 7: Robie & Bell & Quinpool/Cogswell

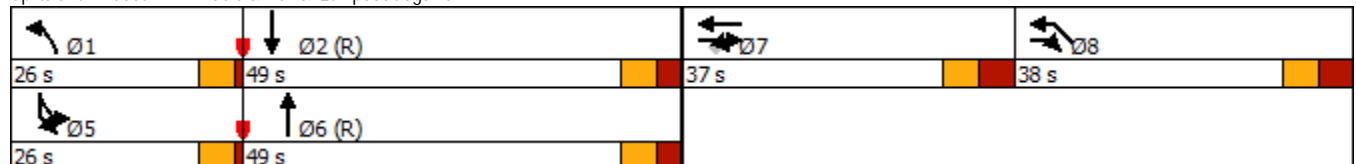

Halifax Transit Priority Corridors
8: Robie & Jubilee/Veterans Memorial

| Lane Group | EBL | EBT | WBL | WBT | WBR | NBL | NBT | SBL | SBT |
|------------------------|-------|--------|-------|-------|-------|--------|-------|-------|-------|
| Lane Configurations | | | | | | | | | |
| Traffic Volume (vph) | 60 | 135 | 15 | 340 | 120 | 160 | 721 | 105 | 18 |
| Future Volume (vph) | 60 | 135 | 15 | 340 | 120 | 160 | 721 | 105 | 18 |
| Lane Group Flow (vph) | 0 | 268 | 0 | 405 | 137 | 183 | 874 | 120 | 21 |
| Turn Type | Perm | NA | Perm | NA | Perm | Prot | NA | Prot | NA |
| Protected Phases | | 8 | | 4 | | 5 | 2 | 1 | 6 |
| Permitted Phases | 8 | | 4 | | 4 | | | | |
| Detector Phase | 8 | 8 | 4 | 4 | 4 | 5 | 2 | 1 | 6 |
| Switch Phase | | | | | | | | | |
| Minimum Initial (s) | 10.0 | 10.0 | 10.0 | 10.0 | 10.0 | 7.0 | 10.0 | 7.0 | 10.0 |
| Minimum Split (s) | 31.6 | 31.6 | 31.6 | 31.6 | 31.6 | 12.0 | 22.8 | 12.0 | 22.8 |
| Total Split (s) | 45.0 | 45.0 | 45.0 | 45.0 | 45.0 | 24.0 | 51.0 | 24.0 | 51.0 |
| Total Split (%) | 37.5% | 37.5% | 37.5% | 37.5% | 37.5% | 20.0% | 42.5% | 20.0% | 42.5% |
| Yellow Time (s) | 4.1 | 4.1 | 4.1 | 4.1 | 4.1 | 4.0 | 4.1 | 4.0 | 4.1 |
| All-Red Time (s) | 2.4 | 2.4 | 2.4 | 2.4 | 2.4 | 1.0 | 1.7 | 1.0 | 1.7 |
| Lost Time Adjust (s) | | 0.0 | | 0.0 | 0.0 | 0.0 | 0.0 | 0.0 | 0.0 |
| Total Lost Time (s) | | 6.5 | | 6.5 | 6.5 | 5.0 | 5.8 | 5.0 | 5.8 |
| Lead/Lag | | | | | | Lead | Lag | Lead | Lag |
| Lead-Lag Optimize? | | | | | | | | | |
| Recall Mode | Ped | Ped | Ped | Ped | Ped | None | C-Min | None | C-Min |
| Act Effct Green (s) | | 40.0 | | 40.0 | 40.0 | 17.3 | 48.8 | 13.9 | 45.4 |
| Actuated g/C Ratio | | 0.33 | | 0.33 | 0.33 | 0.14 | 0.41 | 0.12 | 0.38 |
| v/c Ratio | | 0.86 | | 0.68 | 0.28 | 0.82 | 0.68 | 0.63 | 0.03 |
| Control Delay | | 62.7 | | 41.2 | 12.0 | 68.8 | 49.4 | 64.6 | 25.3 |
| Queue Delay | | 0.0 | | 0.0 | 0.0 | 0.0 | 0.0 | 0.0 | 0.0 |
| Total Delay | | 62.7 | | 41.2 | 12.0 | 68.8 | 49.4 | 64.6 | 25.3 |
| LOS | | E | | D | B | E | D | E | C |
| Approach Delay | | 62.7 | | 33.8 | | | 52.7 | | 58.8 |
| Approach LOS | | E | | C | | | D | | E |
| Queue Length 50th (m) | | 53.0 | | 76.2 | 6.5 | 41.1 | 114.3 | 27.3 | 3.4 |
| Queue Length 95th (m) | | #108.8 | | 119.2 | 22.4 | m#69.9 | 130.4 | 44.9 | 8.4 |
| Internal Link Dist (m) | | 189.8 | | 183.6 | | | 355.1 | | 413.3 |
| Turn Bay Length (m) | | | | | 40.0 | 50.0 | | | |
| Base Capacity (vph) | | 319 | | 610 | 501 | 246 | 1299 | 260 | 686 |
| Starvation Cap Reductn | | 0 | | 0 | 0 | 0 | 0 | 0 | 0 |
| Spillback Cap Reductn | | 0 | | 0 | 0 | 0 | 0 | 0 | 0 |
| Storage Cap Reductn | | 0 | | 0 | 0 | 0 | 0 | 0 | 0 |
| Reduced v/c Ratio | | 0.84 | | 0.66 | 0.27 | 0.74 | 0.67 | 0.46 | 0.03 |

Intersection Summary

Cycle Length: 120
 Actuated Cycle Length: 120
 Offset: 47 (39%), Referenced to phase 2:NBT and 6:SBT, Start of Green
 Natural Cycle: 70
 Control Type: Actuated-Coordinated
 Maximum v/c Ratio: 0.86
 Intersection Signal Delay: 49.4
 Intersection Capacity Utilization 90.4%
 Analysis Period (min) 15
 # 95th percentile volume exceeds capacity, queue may be longer.
 Queue shown is maximum after two cycles.
 m Volume for 95th percentile queue is metered by upstream signal.

Splits and Phases: 8: Robie & Jubilee/Veterans Memorial

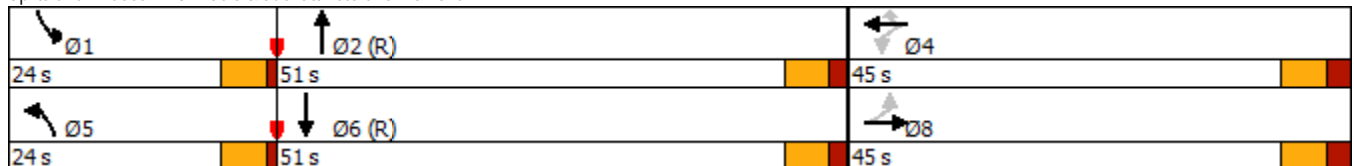









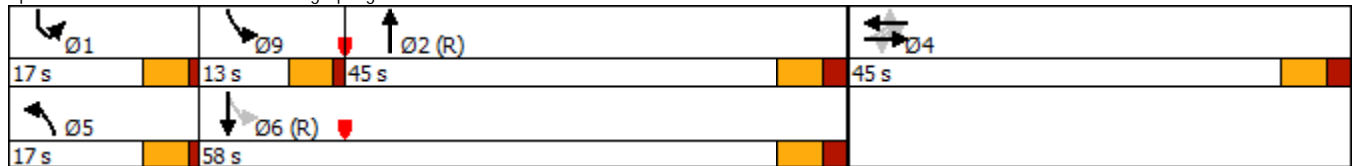











| Lane Group | EBL2 | EBT | WBL | WBT | NBL | NBT | SBL2 | SBL | SBT |
|------------------------|-------|-------|-------|-------|-------|-------|-------|-------|-------|
| Lane Configurations | | | | | | | | | |
| Traffic Volume (vph) | 55 | 135 | 40 | 315 | 160 | 717 | 112 | 8 | 10 |
| Future Volume (vph) | 55 | 135 | 40 | 315 | 160 | 717 | 112 | 8 | 10 |
| Lane Group Flow (vph) | 0 | 217 | 0 | 611 | 183 | 852 | 77 | 0 | 71 |
| Turn Type | Perm | NA | Perm | NA | Prot | NA | Prot | pm+pt | NA |
| Protected Phases | | 4 | | 4 | 5 | 2 | 1 | 9 | 6 |
| Permitted Phases | 4 | | 4 | | | | | 6 | |
| Detector Phase | 4 | 4 | 4 | 4 | 5 | 2 | 1 | 9 | 6 |
| Switch Phase | | | | | | | | | |
| Minimum Initial (s) | 10.0 | 10.0 | 10.0 | 10.0 | 8.0 | 10.0 | 8.0 | 8.0 | 10.0 |
| Minimum Split (s) | 33.5 | 33.5 | 33.5 | 33.5 | 13.0 | 34.5 | 13.0 | 13.0 | 34.5 |
| Total Split (s) | 45.0 | 45.0 | 45.0 | 45.0 | 17.0 | 45.0 | 17.0 | 13.0 | 58.0 |
| Total Split (%) | 37.5% | 37.5% | 37.5% | 37.5% | 14.2% | 37.5% | 14.2% | 10.8% | 48.3% |
| Yellow Time (s) | 4.1 | 4.1 | 4.1 | 4.1 | 4.0 | 4.1 | 4.0 | 4.0 | 4.1 |
| All-Red Time (s) | 2.4 | 2.4 | 2.4 | 2.4 | 1.0 | 2.4 | 1.0 | 1.0 | 2.4 |
| Lost Time Adjust (s) | | 0.0 | | 0.0 | 0.0 | 0.0 | 0.0 | | 0.0 |
| Total Lost Time (s) | | 6.5 | | 6.5 | 5.0 | 6.5 | 5.0 | | 6.5 |
| Lead/Lag | | | | | Lead | | Lead | Lag | Lag |
| Lead-Lag Optimize? | | | | | | | | | |
| Recall Mode | None | None | None | None | None | C-Max | Max | None | C-Max |
| Act Effect Green (s) | | 35.5 | | 35.5 | 14.7 | 51.5 | 15.0 | | 51.9 |
| Actuated g/C Ratio | | 0.30 | | 0.30 | 0.12 | 0.43 | 0.12 | | 0.43 |
| v/c Ratio | | 0.79 | | 0.86 | 0.86 | 0.61 | 0.37 | | 0.29 |
| Control Delay | | 59.2 | | 53.2 | 87.1 | 24.4 | 52.3 | | 34.9 |
| Queue Delay | | 0.0 | | 0.0 | 0.0 | 0.0 | 0.0 | | 0.0 |
| Total Delay | | 59.2 | | 53.2 | 87.1 | 24.4 | 52.3 | | 34.9 |
| LOS | | E | | D | F | C | D | | C |
| Approach Delay | | 59.2 | | 53.2 | | 35.5 | | | 44.0 |
| Approach LOS | | E | | D | | D | | | D |
| Queue Length 50th (m) | | 45.2 | | 69.0 | -46.3 | 68.6 | 19.5 | | 13.0 |
| Queue Length 95th (m) | | #81.1 | | 91.8 | #92.1 | 89.2 | m31.5 | | m24.8 |
| Internal Link Dist (m) | | 121.4 | | 124.9 | | 240.3 | | | 355.1 |
| Turn Bay Length (m) | | | | | 60.0 | | | | |
| Base Capacity (vph) | | 299 | | 768 | 213 | 1404 | 208 | | 243 |
| Starvation Cap Reductn | | 0 | | 0 | 0 | 0 | 0 | | 0 |
| Spillback Cap Reductn | | 0 | | 0 | 0 | 0 | 0 | | 0 |
| Storage Cap Reductn | | 0 | | 0 | 0 | 0 | 0 | | 0 |
| Reduced v/c Ratio | | 0.73 | | 0.80 | 0.86 | 0.61 | 0.37 | | 0.29 |

Intersection Summary

Cycle Length: 120
 Actuated Cycle Length: 120
 Offset: 76 (63%), Referenced to phase 2:NBT and 6:SBTL, Start of Green
 Natural Cycle: 95
 Control Type: Actuated-Coordinated
 Maximum v/c Ratio: 0.86
 Intersection Signal Delay: 44.1
 Intersection Capacity Utilization 111.8%
 Analysis Period (min) 15
 ~ Volume exceeds capacity, queue is theoretically infinite.
 Queue shown is maximum after two cycles.
 # 95th percentile volume exceeds capacity, queue may be longer.
 Queue shown is maximum after two cycles.
 m Volume for 95th percentile queue is metered by upstream signal.

Splits and Phases: 9: Robie & Coburg/Spring Garden



| |  |  |  |  |  |  |  |  |  |  |
|------------------------|---|---|---|---|---|---|---|---|---|---|
| Lane Group | EBL | EBT | WBL | WBT | WBR | NBL | NBT | SBL2 | SBL | SBT |
| Lane Configurations |  |  |  |  |  |  |  |  | |  |
| Traffic Volume (vph) | 45 | 100 | 25 | 145 | 225 | 30 | 659 | 132 | 3 | 7 |
| Future Volume (vph) | 45 | 100 | 25 | 145 | 225 | 30 | 659 | 132 | 3 | 7 |
| Lane Group Flow (vph) | 51 | 137 | 29 | 165 | 257 | 34 | 786 | 89 | 0 | 73 |
| Turn Type | Perm | NA | Perm | NA | pm+ov | Prot | NA | Prot | Perm | NA |
| Protected Phases | | 8 | | 4 | 5 | 1 | 6 | 5 | | 2 |
| Permitted Phases | 8 | | 4 | | 4 | | | | 2 | |
| Detector Phase | 8 | 8 | 4 | 4 | 4 | 1 | 6 | 5 | 2 | 2 |
| Switch Phase | | | | | | | | | | |
| Minimum Initial (s) | 10.0 | 10.0 | 10.0 | 10.0 | 8.0 | 8.0 | 10.0 | 8.0 | 10.0 | 10.0 |
| Minimum Split (s) | 32.5 | 32.5 | 32.5 | 32.5 | 13.0 | 13.0 | 43.3 | 13.0 | 43.3 | 43.3 |
| Total Split (s) | 34.0 | 34.0 | 34.0 | 34.0 | 23.0 | 13.0 | 53.0 | 23.0 | 63.0 | 63.0 |
| Total Split (%) | 30.9% | 30.9% | 30.9% | 30.9% | 20.9% | 11.8% | 48.2% | 20.9% | 57.3% | 57.3% |
| Yellow Time (s) | 4.1 | 4.1 | 4.1 | 4.1 | 4.0 | 4.0 | 4.1 | 4.0 | 4.1 | 4.1 |
| All-Red Time (s) | 2.4 | 2.4 | 2.4 | 2.4 | 1.0 | 1.0 | 3.2 | 1.0 | 3.2 | 3.2 |
| Lost Time Adjust (s) | 0.0 | 0.0 | 0.0 | 0.0 | 0.0 | 0.0 | 0.0 | 0.0 | | 0.0 |
| Total Lost Time (s) | 6.5 | 6.5 | 6.5 | 6.5 | 5.0 | 5.0 | 7.3 | 5.0 | | 7.3 |
| Lead/Lag | | | | | | Lead | | | Lag | Lag |
| Lead-Lag Optimize? | | | | | | | | | | |
| Recall Mode | Ped | Ped | Ped | Ped | None | None | C-Max | None | C-Max | C-Max |
| Act Effct Green (s) | 26.9 | 26.9 | 26.9 | 26.9 | 38.4 | 8.0 | 55.3 | 11.6 | | 61.5 |
| Actuated g/C Ratio | 0.24 | 0.24 | 0.24 | 0.24 | 0.35 | 0.07 | 0.50 | 0.11 | | 0.56 |
| v/c Ratio | 0.27 | 0.28 | 0.12 | 0.42 | 0.68 | 0.28 | 0.53 | 0.52 | | 0.23 |
| Control Delay | 37.8 | 6.7 | 33.6 | 38.6 | 32.8 | 47.1 | 24.5 | 56.8 | | 17.0 |
| Queue Delay | 0.0 | 0.0 | 0.0 | 0.0 | 0.0 | 0.0 | 0.0 | 0.0 | | 0.0 |
| Total Delay | 37.8 | 6.7 | 33.6 | 38.6 | 32.8 | 47.1 | 24.5 | 56.8 | | 17.0 |
| LOS | D | A | C | D | C | D | C | E | | B |
| Approach Delay | | 15.1 | | 34.9 | | | 25.5 | | | 38.9 |
| Approach LOS | | B | | C | | | C | | | D |
| Queue Length 50th (m) | 8.8 | 0.0 | 4.8 | 29.7 | 31.9 | 7.2 | 56.8 | 19.4 | | 9.0 |
| Queue Length 95th (m) | 19.8 | 13.6 | 12.5 | 49.3 | 49.7 | m12.7 | 94.0 | 34.7 | | 19.5 |
| Internal Link Dist (m) | | 178.0 | | 171.4 | | | 167.5 | | | 240.3 |
| Turn Bay Length (m) | 15.0 | | 15.0 | | 60.0 | 60.0 | | 60.0 | | |
| Base Capacity (vph) | 196 | 497 | 253 | 406 | 380 | 122 | 1488 | 266 | | 315 |
| Starvation Cap Reductn | 0 | 0 | 0 | 0 | 0 | 0 | 0 | 0 | | 0 |
| Spillback Cap Reductn | 0 | 0 | 0 | 0 | 0 | 0 | 0 | 0 | | 0 |
| Storage Cap Reductn | 0 | 0 | 0 | 0 | 0 | 0 | 0 | 0 | | 0 |
| Reduced v/c Ratio | 0.26 | 0.28 | 0.11 | 0.41 | 0.68 | 0.28 | 0.53 | 0.33 | | 0.23 |

Intersection Summary

Cycle Length: 110
 Actuated Cycle Length: 110
 Offset: 88 (80%), Referenced to phase 2:SBTL and 6:NBT, Start of Green
 Natural Cycle: 90
 Control Type: Actuated-Coordinated
 Maximum v/c Ratio: 0.68
 Intersection Signal Delay: 28.2
 Intersection Capacity Utilization 106.7%
 Analysis Period (min) 15
 m Volume for 95th percentile queue is metered by upstream signal.

Splits and Phases: 10: Robie & University

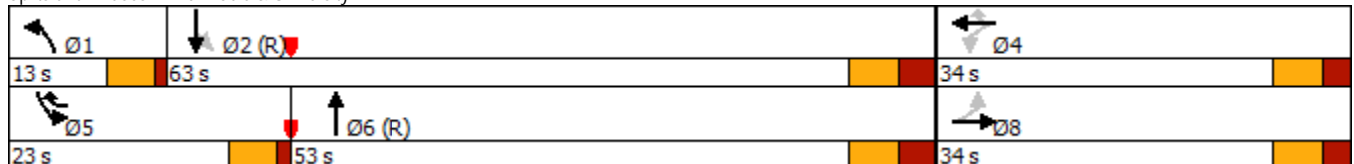

| Lane Group | EBL2 | EBT | WBL | WBT | WBR | NBL | NBT | SBL2 | SBL | SBT |
|------------------------|-------|-------|-------|-------|-------|-------|-------|-------|-------|-------|
| Lane Configurations | | | | | | | | | | |
| Traffic Volume (vph) | 55 | 205 | 20 | 345 | 245 | 42 | 326 | 91 | 4 | 0 |
| Future Volume (vph) | 55 | 205 | 20 | 345 | 245 | 42 | 326 | 91 | 4 | 0 |
| Lane Group Flow (vph) | 0 | 320 | 0 | 417 | 280 | 48 | 389 | 58 | 0 | 54 |
| Turn Type | Perm | NA | Perm | NA | Perm | Prot | NA | Prot | Perm | NA |
| Protected Phases | | 4 | | 4 | | 5 | 2 | 1 | | 6 |
| Permitted Phases | 4 | | 4 | | 4 | | | | 6 | |
| Detector Phase | 4 | 4 | 4 | 4 | 4 | 5 | 2 | 1 | 6 | 6 |
| Switch Phase | | | | | | | | | | |
| Minimum Initial (s) | 10.0 | 10.0 | 10.0 | 10.0 | 10.0 | 8.0 | 10.0 | 8.0 | 10.0 | 10.0 |
| Minimum Split (s) | 47.8 | 47.8 | 47.8 | 47.8 | 47.8 | 13.0 | 24.7 | 13.0 | 24.7 | 24.7 |
| Total Split (s) | 55.0 | 55.0 | 55.0 | 55.0 | 55.0 | 13.0 | 42.0 | 13.0 | 42.0 | 42.0 |
| Total Split (%) | 50.0% | 50.0% | 50.0% | 50.0% | 50.0% | 11.8% | 38.2% | 11.8% | 38.2% | 38.2% |
| Yellow Time (s) | 4.1 | 4.1 | 4.1 | 4.1 | 4.1 | 4.0 | 4.1 | 4.0 | 4.1 | 4.1 |
| All-Red Time (s) | 2.7 | 2.7 | 2.7 | 2.7 | 2.7 | 0.0 | 1.6 | 0.0 | 1.6 | 1.6 |
| Lost Time Adjust (s) | | 0.0 | | 0.0 | 0.0 | 0.0 | 0.0 | 0.0 | | 0.0 |
| Total Lost Time (s) | | 6.8 | | 6.8 | 6.8 | 4.0 | 5.7 | 4.0 | | 5.7 |
| Lead/Lag | | | | | | Lead | Lag | Lead | Lag | Lag |
| Lead-Lag Optimize? | | | | | | | | | | |
| Recall Mode | Ped | Ped | Ped | Ped | Ped | None | C-Min | Min | C-Min | C-Min |
| Act Effct Green (s) | | 43.0 | | 43.0 | 43.0 | 8.8 | 41.5 | 9.0 | | 44.1 |
| Actuated g/C Ratio | | 0.39 | | 0.39 | 0.39 | 0.08 | 0.38 | 0.08 | | 0.40 |
| v/c Ratio | | 0.76 | | 0.61 | 0.51 | 0.38 | 0.59 | 0.43 | | 0.17 |
| Control Delay | | 41.0 | | 30.9 | 29.0 | 57.1 | 26.7 | 56.6 | | 12.2 |
| Queue Delay | | 0.0 | | 0.0 | 0.0 | 0.0 | 0.0 | 0.0 | | 0.0 |
| Total Delay | | 41.0 | | 30.9 | 29.0 | 57.1 | 26.7 | 56.6 | | 12.2 |
| LOS | | D | | C | C | E | C | E | | B |
| Approach Delay | | 41.0 | | 30.2 | | | 30.1 | | | 35.2 |
| Approach LOS | | D | | C | | | C | | | D |
| Queue Length 50th (m) | | 59.6 | | 72.9 | 46.6 | 10.0 | 51.2 | 13.2 | | 0.0 |
| Queue Length 95th (m) | | 86.5 | | 94.2 | 64.6 | 21.9 | 91.0 | 26.6 | | 8.8 |
| Internal Link Dist (m) | | 115.5 | | 183.6 | | | 422.3 | | | 167.5 |
| Turn Bay Length (m) | | | | | 50.0 | | | 60.0 | | |
| Base Capacity (vph) | | 472 | | 762 | 609 | 132 | 662 | 141 | | 320 |
| Starvation Cap Reductn | | 0 | | 0 | 0 | 0 | 0 | 0 | | 0 |
| Spillback Cap Reductn | | 0 | | 0 | 0 | 0 | 0 | 0 | | 0 |
| Storage Cap Reductn | | 0 | | 0 | 0 | 0 | 0 | 0 | | 0 |
| Reduced v/c Ratio | | 0.68 | | 0.55 | 0.46 | 0.36 | 0.59 | 0.41 | | 0.17 |

Intersection Summary

Cycle Length: 110
 Actuated Cycle Length: 110
 Offset: 108 (98%), Referenced to phase 2:NBT and 6:SBTL, Start of Green
 Natural Cycle: 90
 Control Type: Actuated-Coordinated
 Maximum v/c Ratio: 0.76
 Intersection Signal Delay: 32.7
 Intersection Capacity Utilization 124.2%
 Analysis Period (min) 15

Intersection LOS: C
 ICU Level of Service H

Splits and Phases: 11: Robie & South

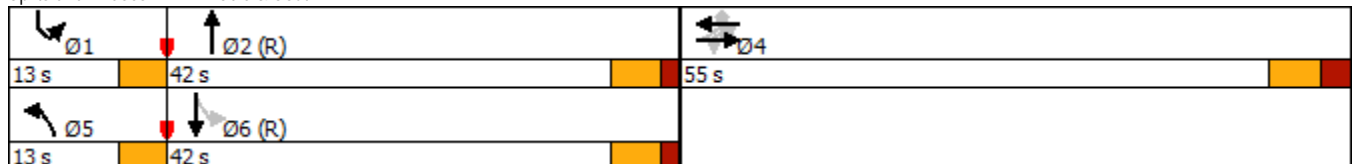

| Lane Group | EBL | EBT | WBL | WBT | WBR | NBL | NBT | SBL | SBT |
|------------------------|-------|-------|-------|-------|--------|-------|-------|-------|-------|
| Lane Configurations | | | | | | | | | |
| Traffic Volume (vph) | 20 | 235 | 80 | 275 | 275 | 30 | 125 | 175 | 70 |
| Future Volume (vph) | 20 | 235 | 80 | 275 | 275 | 30 | 125 | 175 | 70 |
| Lane Group Flow (vph) | 0 | 320 | 0 | 405 | 314 | 0 | 268 | 200 | 97 |
| Turn Type | Perm | NA | Perm | NA | custom | Perm | NA | pm+pt | NA |
| Protected Phases | | 8 | | 4 | | | 6 | 5 | 2 |
| Permitted Phases | 8 | | 4 | | 4 5 | 6 | | 2 | |
| Detector Phase | 8 | 8 | 4 | 4 | 4 5 | 6 | 6 | 5 | 2 |
| Switch Phase | | | | | | | | | |
| Minimum Initial (s) | 10.0 | 10.0 | 10.0 | 10.0 | | 10.0 | 10.0 | 8.0 | 10.0 |
| Minimum Split (s) | 31.7 | 31.7 | 31.7 | 31.7 | | 23.1 | 23.1 | 11.0 | 23.1 |
| Total Split (s) | 40.0 | 40.0 | 40.0 | 40.0 | | 39.0 | 39.0 | 11.0 | 50.0 |
| Total Split (%) | 44.4% | 44.4% | 44.4% | 44.4% | | 43.3% | 43.3% | 12.2% | 55.6% |
| Yellow Time (s) | 4.1 | 4.1 | 4.1 | 4.1 | | 4.1 | 4.1 | 3.0 | 4.1 |
| All-Red Time (s) | 2.6 | 2.6 | 2.6 | 2.6 | | 2.0 | 2.0 | 0.0 | 2.0 |
| Lost Time Adjust (s) | | 0.0 | | 0.0 | | | 0.0 | 0.0 | 0.0 |
| Total Lost Time (s) | | 6.7 | | 6.7 | | | 6.1 | 3.0 | 6.1 |
| Lead/Lag | | | | | | Lag | Lag | Lead | |
| Lead-Lag Optimize? | | | | | | | | | |
| Recall Mode | Ped | Ped | Max | Max | | C-Min | C-Min | None | C-Min |
| Act Effct Green (s) | | 44.9 | | 44.9 | 55.9 | | 21.3 | 35.4 | 32.3 |
| Actuated g/C Ratio | | 0.50 | | 0.50 | 0.62 | | 0.24 | 0.39 | 0.36 |
| v/c Ratio | | 0.37 | | 0.56 | 0.31 | | 0.78 | 0.60 | 0.18 |
| Control Delay | | 16.9 | | 21.4 | 2.2 | | 42.8 | 25.4 | 15.0 |
| Queue Delay | | 0.0 | | 0.0 | 0.0 | | 0.0 | 0.0 | 0.0 |
| Total Delay | | 16.9 | | 21.4 | 2.2 | | 42.8 | 25.4 | 15.0 |
| LOS | | B | | C | A | | D | C | B |
| Approach Delay | | 16.9 | | 13.0 | | | 42.8 | | 22.0 |
| Approach LOS | | B | | B | | | D | | C |
| Queue Length 50th (m) | | 31.9 | | 46.6 | 0.0 | | 38.4 | 23.3 | 9.2 |
| Queue Length 95th (m) | | 61.8 | | 90.5 | 11.5 | | 57.6 | 32.4 | 16.5 |
| Internal Link Dist (m) | | 113.9 | | 142.4 | | | 118.8 | | 422.3 |
| Turn Bay Length (m) | | | | | 50.0 | | | 60.0 | |
| Base Capacity (vph) | | 854 | | 722 | 1002 | | 515 | 336 | 726 |
| Starvation Cap Reductn | | 0 | | 0 | 0 | | 0 | 0 | 0 |
| Spillback Cap Reductn | | 0 | | 0 | 0 | | 0 | 0 | 0 |
| Storage Cap Reductn | | 0 | | 0 | 0 | | 0 | 0 | 0 |
| Reduced v/c Ratio | | 0.37 | | 0.56 | 0.31 | | 0.52 | 0.60 | 0.13 |

Intersection Summary

Cycle Length: 90
 Actuated Cycle Length: 90
 Offset: 0 (0%), Referenced to phase 2:SBTL and 6:NBTL, Start of Green
 Natural Cycle: 70
 Control Type: Actuated-Coordinated
 Maximum v/c Ratio: 0.78
 Intersection Signal Delay: 20.5
 Intersection Capacity Utilization 87.2%
 Analysis Period (min) 15

Intersection LOS: C
 ICU Level of Service E

Splits and Phases: 12: Robie & Inglis

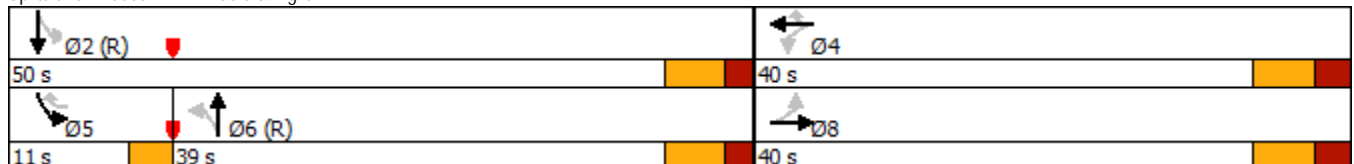

YOUNG STREET - WINDSOR STREET TO ROBIE STREET



Existing Cross Section



Key Map - Young Street

LOW INVESTMENT: OUTBOUND TRANSIT LANE

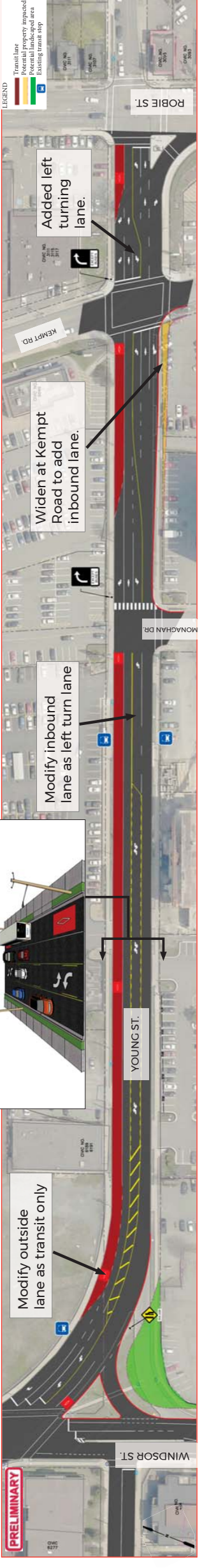

IMPACTS

| | | | | | |
|--|---|--|--|--|------------|
| | Provides curbside transit lanes in westbound direction. | | Longer pedestrian crossing at Kempt Road and Windsor Street. | | No impact. |
| | Fewer through lanes increase vehicle queues. Additional left turn lanes at driveways. | | Slight widening at Kempt Road intersection may impact adjacent property. | | No impact. |

PROS

- Improves flow of transit vehicles in westbound direction.
- Reduces potential for rear end conflicts with added left turn lanes at driveways.

CONS

- Road widening may impact adjacent property.
- Longer pedestrian crossings at Kempt Road.

ATTACHMENT B

MEDIUM INVESTMENT: INBOUND AND OUTBOUND TRANSIT LANE

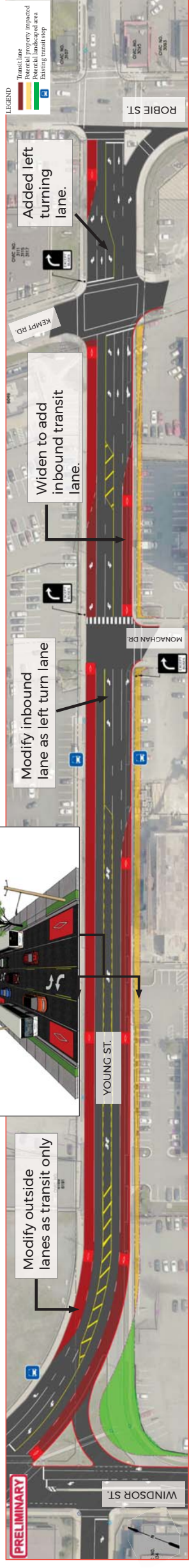

IMPACTS

| | | | | | |
|--|---|--|--|--|------------|
| | Provides curbside transit lanes in both directions. | | Longer pedestrian crossings at Monaghan Drive, Kempt Road, and Windsor Street. | | No impact. |
| | Fewer through lanes increase vehicle queues. Additional left turn lanes at driveways. | | Widening may impact properties along the corridor. | | No impact. |

PROS

- Improves flow of transit vehicles in both directions.
- Reduces potential for rear end conflicts with added left turn lanes.

CONS

- Road widening may impact adjacent properties.
- Longer pedestrian crossings at Monaghan Drive, Kempt Road, and Windsor Street.

HIGH INVESTMENT: OUTBOUND AND EXTENDED INBOUND TRANSIT

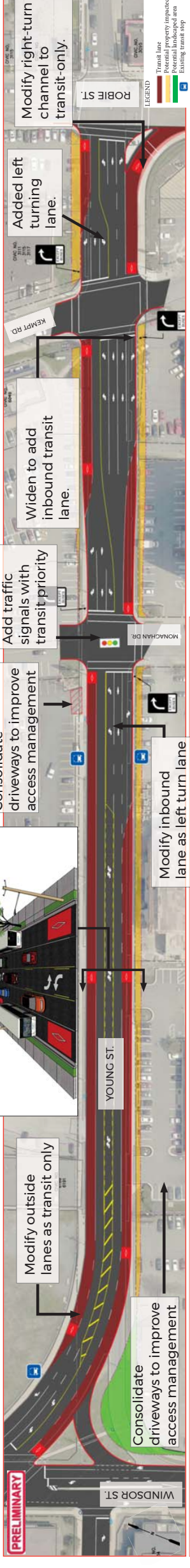

IMPACTS

| | | | | | |
|--|---|--|---|--|------------------------|
| | Provides curbside transit lanes in both directions. | | Longer pedestrian crossings. Signalized pedestrian crossing added at Monaghan Drive. | | No impact. |
| | Fewer through lanes increase vehicle queues. Improved driveway access management. | | Widening may impact properties along the corridor. Access modifications impact adjacent properties. | | Impacts 3 large trees. |

PROS

- Improves flow of transit vehicles in both directions.
- Access management improvements reduce conflict points.
- Reduces potential for rear end conflicts with added left turn lanes at driveways.
- Improves access to Robie Street (southbound) for transit vehicles.

CONS

- Road widening may impact adjacent properties.
- Longer pedestrian crossings at Monaghan Drive, Kempt Road, and Robie Street.

ATTACHMENT B

ROBIE STREET - YOUNG STREET TO ALMON STREET

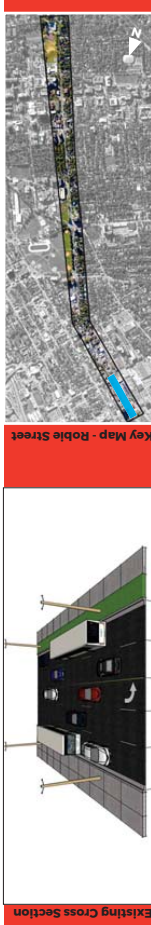

CURBSIDE BUS LANES: BOTH DIRECTIONS (NORTH OF ALMON ST.)

| | | | | | |
|--|---|--|------------------|--|------------------------------------|
| | Provides curbside transit lanes in both directions. | | No impact. | | Loss of parking south of Almon St. |
| | Minimal impact to traffic. | | No major impact. | | No impact. |

IMPROVEMENTS

- Improves flow of transit vehicles in both directions (north of Almon Street).
- Provides continuous northbound transit lane (south of Demone Street).

CONS

- Fewer travel lanes for non-transit traffic will increase queuing on Robie Street.
- Require merging by northbound left-turning transit vehicles to Young Street.

LEGEND

- Transit Lane
- Potential property impacted
- Normal landscaped area
- Existing transit stop

CURBSIDE BUS LANES: BOTH DIRECTIONS

| | | | | | |
|--|---|--|---|--|--|
| | Provides curbside transit lanes in both directions. | | No impact. | | Loss of parking south of Almon St. |
| | Minimal impact to traffic. | | No impact north of Almon St. Some impact south of Almon St. | | No impact north of Almon St. See next board for impacts south of Almon St. |

IMPROVEMENTS

- Improves flow of transit vehicles in both directions.
- Northbound transit lane provided but ends before Young Street.

CONS

- Fewer travel lanes for non-transit traffic will increase queuing on Robie Street.
- Requires merging by northbound left-turning transit vehicles to Young Street.

LEGEND

- Transit Lane
- Potential property impacted
- Normal landscaped area
- Existing transit stop

CENTRE MEDIAN BUS LANES

| | | | | | |
|--|---|--|--|--|--|
| | Provides centre median transit lanes in both directions. | | Longer pedestrian crossings at Almon Street. | | Loss of parking south of Almon St. |
| | Longer and additional alternative routing for local traffic with elimination of many left turns | | Impacts to properties near Almon Street. | | No impact north of Almon St. See next board for impacts south of Almon St. |

IMPROVEMENTS

- Improves flow of transit vehicles in both directions.
- Better aligns northbound buses to turn left onto Young Street.

CONS

- Added delay at signalized intersections for all users.
- Fewer travel lanes for non-transit traffic on Robie Street.
- Restricts mid-block left turn movements.
- Turn restrictions could increase routing for local traffic.

LEGEND

- Transit Lane
- Potential property impacted
- Normal landscaped area
- Existing transit stop

ROBIE STREET - ALMON STREET TO WILLOW STREET



CURBSIDE BUS LANES: NORTHBOUND ONLY



| | | | | | |
|--|--|--|---|--|---|
| | Provides curbside transit lanes in northbound direction. | | Longer pedestrian crossings at North Street. | | Loss of on-street parking. |
| | Restricted northbound left at Almon Street will divert additional traffic to Young Street. | | Road widening may impact properties at North Street intersection. | | Road widening will impact one large tree. |

- PROS**
- Improves flow of transit vehicles in northbound direction.
- CONS**
- No southbound transit priority.
 - Restricts northbound left turns to Almon Street.
 - Loss of on-street parking.
 - Road widening will impact adjacent properties and tree at North Street.

ATTACHMENT B

CURBSIDE BUS LANES: BOTH DIRECTIONS

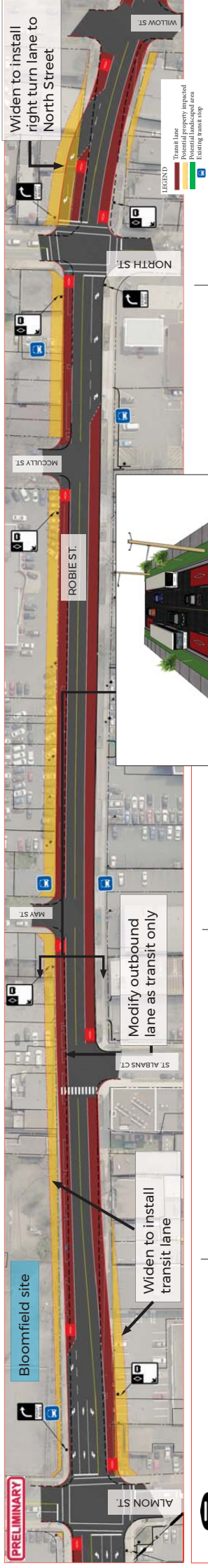

| | | | | | |
|--|--|--|---|--|---|
| | Provides curbside transit lanes in both directions. | | Longer pedestrian crossings. | | Loss of on-street parking. |
| | Added left turn lane at Almon Street going northbound. | | Road widening may impact several properties along the corridor. | | Road widening will impact 4 large trees, 3 medium trees |

- PROS**
- Improves flow of transit vehicles in both directions.
 - Provides left-turn traffic lane (northbound) on to Almon Street.
- CONS**
- Longer pedestrian crossings.
 - Road widening will impact adjacent properties and street trees.
 - Loss of on-street parking.

CENTRE MEDIAN BUS LANES



| | | | | | |
|--|---|--|--|--|--|
| | Provides centre median transit lanes in both directions. | | Longer pedestrian crossings at all crossings. | | Loss of on-street parking. |
| | Required traffic signal phasing for left turns will delay through-traffic. Longer routing for local traffic with elimination of many left turns | | Widening may impact several properties along the corridor. | | Road widening will impact 4 large trees, 3 medium trees. |

- PROS**
- Improves flow of transit vehicles in both directions.
 - Provides left-turn traffic lane (northbound) on to Almon Street.
- CONS**
- Added delay at signalized intersections for all users.
 - Road widening will impact adjacent properties and street trees.
 - Loss of on-street parking.
 - Restricts mid-block left turn movements. Turn restrictions could increase routing for local traffic.

ATTACHMENT B

ROBIE STREET - WILLOW STREET TO COMPTON AVENUE

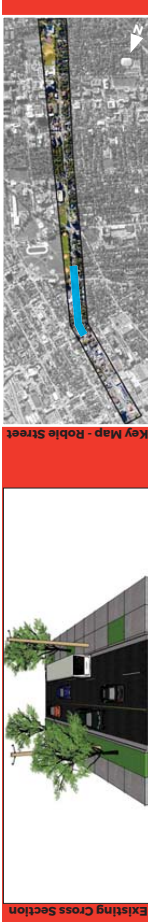

CURBSIDE BUS LANES: NORTHBOUND ONLY



| IMPACTS | |
|---------|--|
| | Provides curbside transit lanes in northbound direction. |
| | Loss of northbound traffic lane. |
| | Loss of median refuge at Cunard Street. Shorter crossing at Cunard Street. |
| | No major impact. |
| | No impact. |
| | No impact |

- PROS**
- Improves flow of transit vehicles in northbound direction.
 - Significant improvements to alignment at Cunard / Robie intersection.

- CONS**
- No southbound transit priority.
 - May impact flow of traffic (northbound) during peak periods.

CURBSIDE BUS LANES: BOTH DIRECTIONS



| IMPACTS | |
|---------|--|
| | Provides curbside transit lanes in both directions. |
| | Loss of right-turn lane. Loss of northbound traffic lane. Improved alignment at Cunard Street intersection |
| | Longer pedestrian crossings. Shorter crossing at Cunard. |
| | Widening may impact properties along the corridor. Halifax Common green space gained. |
| | No impact. |
| | Road widening will impact 8 large trees, 1 medium tree. |

- PROS**
- Improves flow of transit vehicles in both directions.
 - Significant improvements to alignment at Cunard / Robie intersection.
 - Gains to Halifax Common land at southeast corner of Cunard Street intersection.

- CONS**
- Longer pedestrian crossings.
 - Road widening will impact adjacent properties and trees.
 - May impact flow of traffic (northbound) during peak periods.

CENTRE MEDIAN BUS LANES

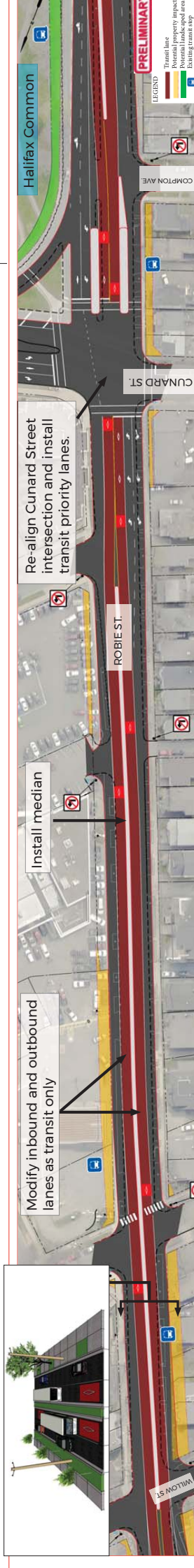

| IMPACTS | |
|---------|---|
| | Provides centre median transit lanes in both directions. |
| | Traffic signal phasing will increase intersection delay. Left turns to/from unsignalized side streets prohibited. |
| | Longer pedestrian crossings of Robie at Almon Street. |
| | Widening may impact several properties along the corridor. |
| | No impact. |
| | Road widening will impact 8 large trees, 1 medium tree. |

- PROS**
- Improves flow of transit vehicles in both directions.
 - Improvements to alignment at Cunard / Robie intersection.
 - Gains to Halifax Common land at southeast corner of Cunard Street intersection.
 - Aligns buses for left turns to Cunard Street.

- CONS**
- Added delay at signalized intersections for all users.
 - Road widening will impact adjacent trees and properties
 - May impact flow of traffic (northbound) during peak periods
 - Restricts mid-block left turn movements. Turn restrictions could increase routing for local traffic.

ROBIE STREET - WILLIAMS STREET TO SHIRLEY STREET

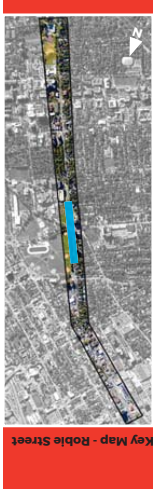

CURBSIDE BUS LANES

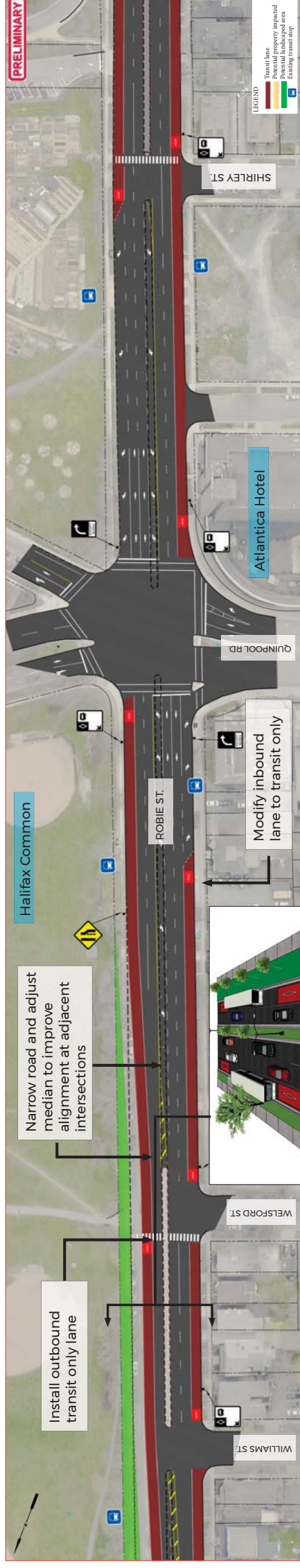

IMPACTS

| | | | | | |
|--|---|--|--|--|--|
| | Provides curbside transit lanes in both directions. | | Shorter pedestrian crossings at Welsford Street. Elimination of median refuge at Quinpool intersection. | | Loss of on-street parking. |
| | Fewer through lanes in both directions. | | Halifax Common greenspace gained. | | Small trees will be lost with the removal of the median. Road narrowing will provide additional greenspace around the Common. |

PROS

- Improves flow of transit vehicles in both directions.
- Road narrowing will provide additional greenspace at the Halifax Common.
- Shorter pedestrian crossing at Welsford Avenue.
- Improved northbound alignment at Quinpool Road intersection

CONS

- Loss of on-street parking along Robie Street.
- Loss of median refuge at Quinpool Rd. intersection.

CENTRE MEDIAN BUS LANES

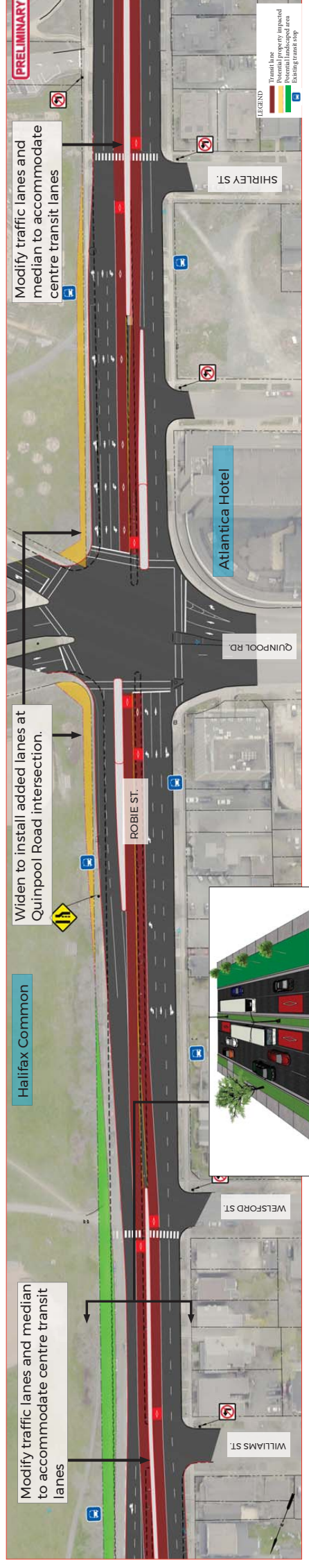

IMPACTS

| | | | | | |
|--|--|--|--|--|--|
| | Provides centre median transit lanes in both directions. | | Shorter pedestrian crossings at Welsford Avenue. Longer pedestrian crossings at Quinpool Road intersection. | | Loss of on-street parking. |
| | Traffic signal phasing will increase intersection delay. Left turns to/from unsignalized side streets prohibited. | | Halifax Common greenspace gained. Impact on Common property near Cogswell Street. | | Road widening will impact 10 large trees. Small trees will be relocated with changes to the median. |

PROS

- Improves flow of transit vehicles in both directions.
- Road narrowing will provide additional greenspace at the Halifax Common.
- Shorter pedestrian crossing at Welsford.
- Improved alignment at Quinpool Road. intersection.

CONS

- Added delay at signalized intersections for all users.
- Loss of on-street parking along Robie Street.
- Road widening will impact adjacent Common property and trees.
- Restricts mid-block left turn movements. Turn restrictions could increase routing for local traffic.

ATTACHMENT B

ROBIE STREET - CHERRY STREET TO BLISS STREET

Existing Cross Section



CURBSIDE BUS LANES

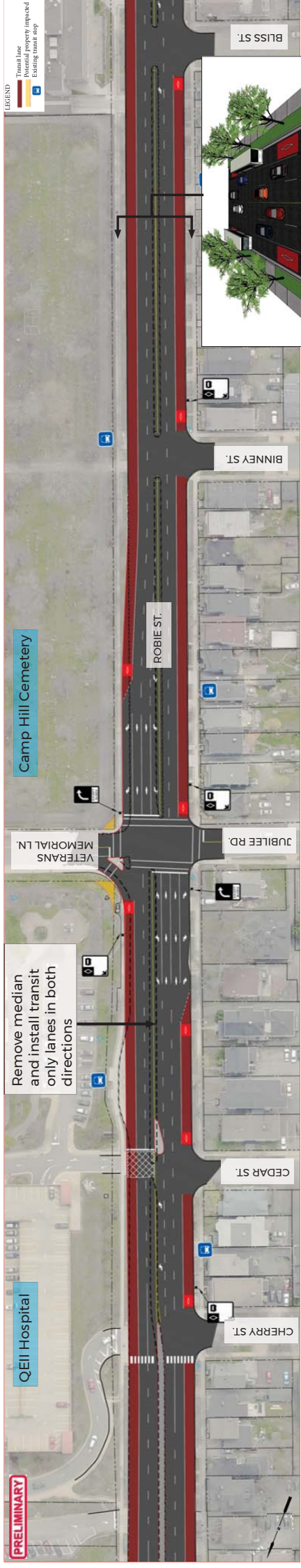

| IMPACTS | |
|---------|---|
| | Provides curbside transit lanes in both directions. |
| | Minimal impact to traffic. |
| | Longer pedestrian crossings of Robie at Jubilee Road. Loss of median refuge at Jubilee Road. |
| | Minor impact to properties at Jubilee intersection. |
| | Loss of on-street parking. |
| | Road widening at Veteran's Memorial Lane will impact 5 medium trees. |

PROS

- Improves flow of transit vehicles in both directions.
- Minimal impact to traffic flow.

CONS

- Loss of parking along Robie Street.
- Loss of small trees with removal of the median.

CENTRE MEDIAN BUS LANES

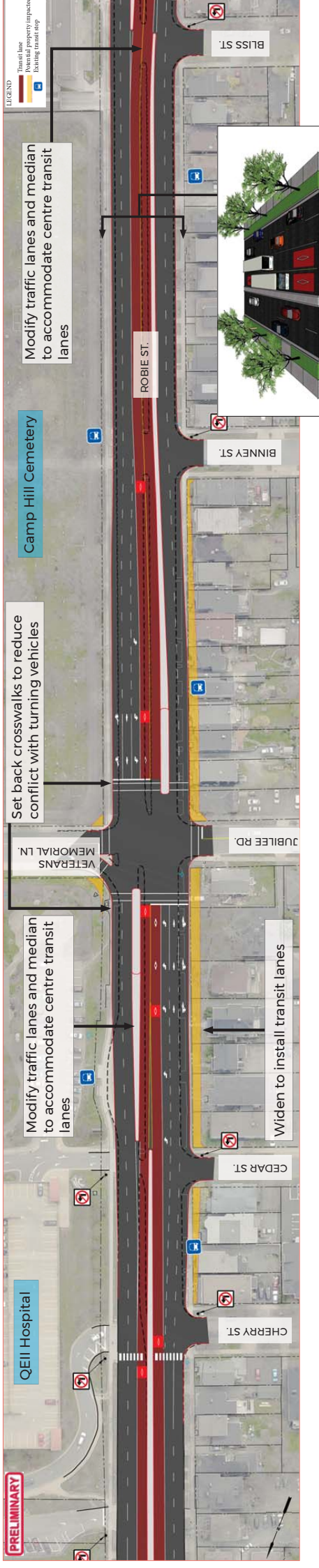

| IMPACTS | |
|---------|--|
| | Provides centre median transit lanes in both directions. |
| | Traffic signal phasing will increase intersection delay. Left turns to/from unsignalized side streets prohibited. |
| | Longer pedestrian crossings of Robie at Jubilee Road. |
| | Widening will impact several properties along the corridor. Restricts left turn movements into existing QEI Hospital driveway. |
| | Loss of on-street parking. |
| | Road widening will impact 18 large trees, 9 medium trees. Loss of small trees with the adjustment of the median. |

PROS

- Improves flow of transit vehicles in both directions.

CONS

- Added delay at signalized intersections for all users.
- Loss of on-street parking along Robie Street.
- Road widening will impact adjacent properties and trees.
- Restricts mid-block left turn movements. Turn restrictions could increase routing for local traffic.

ATTACHMENT B

ROBIE STREET - BLISS STREET TO SOUTH STREET



Existing Cross Section



Key Map - Robie Street

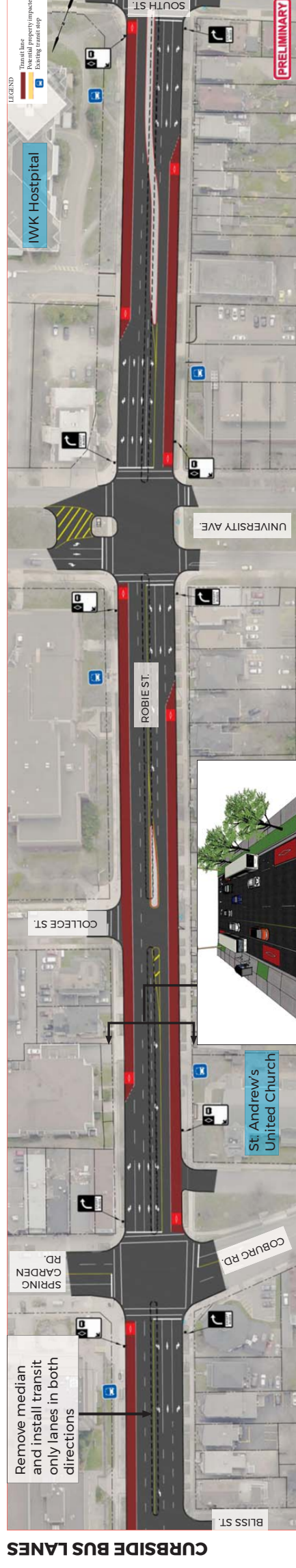

CURBSIDE BUS LANES

| IMPAIRMENTS | | PROS | | CONS | |
|-------------|---|------|--|------|--|
| | Provides curbside transit lanes in both directions. | | Loss of median refuge at Spring Garden Road | | Loss of on-street parking |
| | Minimal impact to traffic. | | No major impact. | | Loss of small trees with the removal of the median. |
| | | | <ul style="list-style-type: none"> Improves flow of transit vehicles in both directions. Minimal impact to traffic flow. | | <ul style="list-style-type: none"> Loss of parking along Robie Street. Loss of small trees with removal of the median. |



CENTRE MEDIAN BUS LANES

| IMPAIRMENTS | | PROS | | CONS | |
|-------------|---|------|--|------|--|
| | Provides centre median transit lanes in both directions. | | Longer and setback pedestrian crossings at Spring Garden Road and South Street. Eliminates boulevard buffer between sidewalk and street. | | Loss of on-street parking. |
| | Traffic signal phasing will increase intersection delay. Left turns to/from unsignalized side streets prohibited. | | Some impact near Coburg Road. | | Road widening will impact 5 large trees, 4 medium trees. Loss of small trees with the removal of the median. |
| | | | <ul style="list-style-type: none"> Improves flow of transit vehicles in both directions. | | <ul style="list-style-type: none"> Added delay at signalized intersections for all users. Loss of on-street parking along Robie Street. Road widening will impact adjacent trees. Restricts mid-block left turn movements. Turn restrictions could increase routing for local traffic. |

ATTACHMENT B

ROBIE STREET - SOUTH STREET TO INGLIS STREET



Existing Cross Section



Key Map - Robie Street

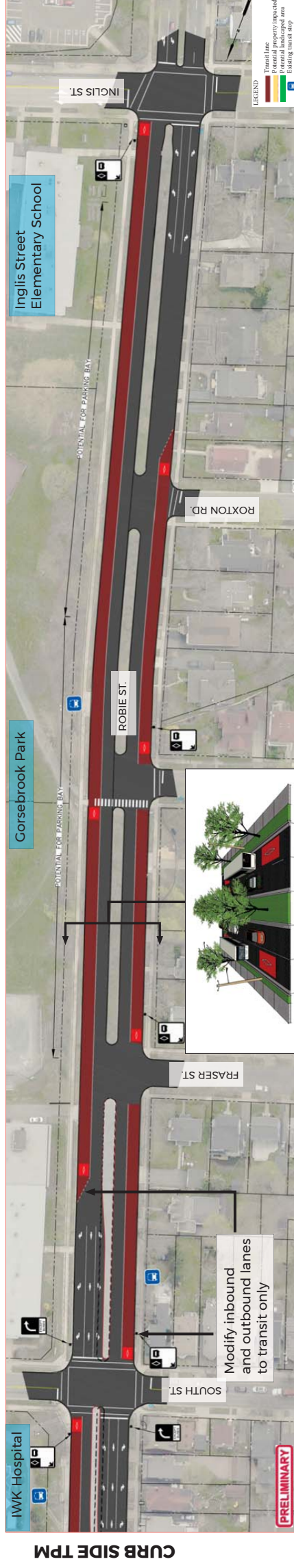

CURB SIDE TPM

IMPACTS

| | | | | | |
|--|---|--|------------------|--|--|
| | Provides curbside transit lanes in both directions. | | No impact. | | Loss of on-street parking. |
| | Minimal impact to traffic. | | No major impact. | | Loss of two medium trees with the removal of the median section at South Street. |

PROS

- Improves flow of transit vehicles in both directions.
- Minimal impact to traffic flow.

CONS

- Loss of parking along Robie Street.

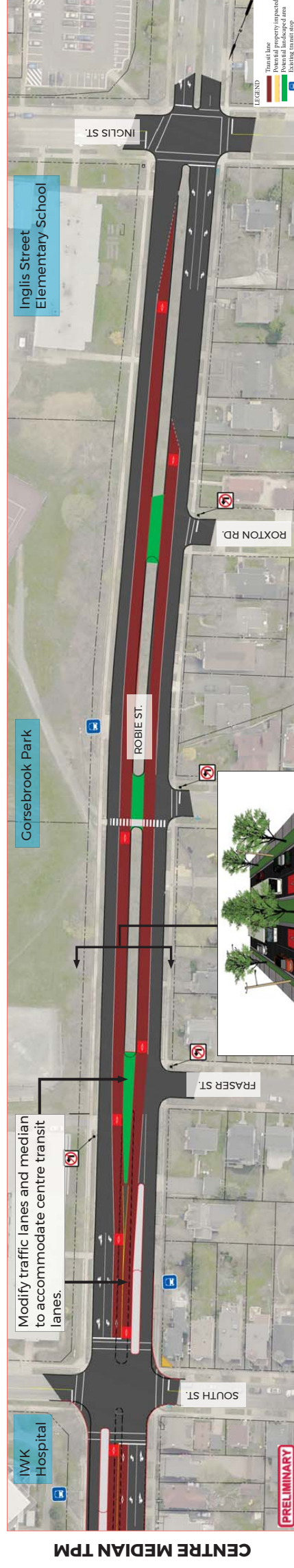

CENTRE MEDIAN TPM

IMPACTS

| | | | | | |
|--|---|--|-------------------------------------|--|--|
| | Provides centre median transit lanes in both directions. | | No impact. | | Loss of on-street parking. |
| | Traffic signal phasing will increase intersection delay. Left turns to/from unsignalized side streets prohibited. | | Impact to property at South Street. | | Loss of 4 medium trees with the removal of the median section at South Street. |

PROS

- Improves flow of transit vehicles in both directions.

CONS

- Added delay at signalized intersections for all users.
- Loss of on-street parking along Robie Street.
- Restricts mid-block left turn movements. Turn restrictions could increase routing for local traffic.

Traffic Impact Analysis

Robie Street / Young Street Transit Priority Corridor

Prepared by:

Strategic Transportation Planning
May 2019



Table of Contents

| | |
|--|-----------|
| Introduction | 3 |
| Background | 3 |
| Objective | 3 |
| Existing Conditions..... | 3 |
| Robie Street | 3 |
| Young Street | 4 |
| Proposed Transit Priority Upgrades..... | 5 |
| Robie Street | 5 |
| Intersection Configuration Changes..... | 6 |
| Young Street | 9 |
| Intersection Configuration Changes..... | 10 |
| Concluding Thoughts | 12 |

Introduction

Background

Halifax Regional Municipality (HRM) are currently in the process of planning and design for proposed transit priority upgrades to Robie Street. Staff have recommended that the project be implemented in phases, the first of which would include installation of curbside bus lanes on the following segments of Robie Street (Figure 1):

- Young Street to Almon Street: Northbound / southbound bus lanes
- Almon Street to Cunard Street: Northbound bus lane
- Cunard Street to Quinpool Road: Northbound / southbound bus lanes

Proposed Phase 1 changes do not require widening, but do necessitate reconfiguration of existing curb-to-curb space that is currently used for traffic lanes and parking / loading. Accordingly, there are areas along Robie Street where it will be necessary to reduce traffic capacity at intersections and mid-block locations. Staff have completed an analysis of the traffic impacts associated with the proposed changes. These findings supplement the analyses that were completed by WSP for the various options considered for the Robie Street / Young Street Transit Priority Corridor.

Objective

The objective of the traffic impact analysis is to review the impacts to traffic operation on Robie Street and Young Street that are anticipated to result from the implementation of Phase 1 transit priority upgrades.

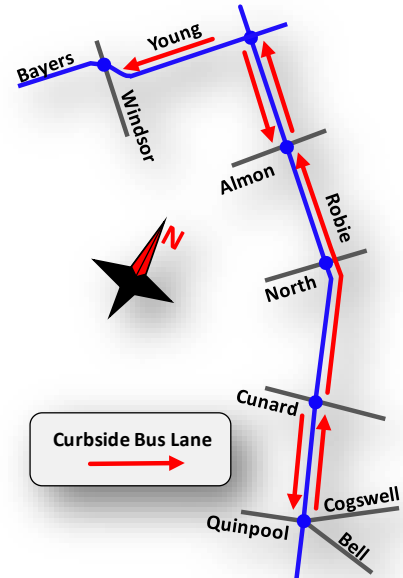

Figure 1: Proposed Phase 1 Transit Priority Upgrades

Existing Conditions

Robie Street

Robie Street runs north-south centrally across the Halifax peninsula, connecting the north and south ends over approximately 4km. A key link in the regional roadway network, it accommodates between 15,000 and 25,000 vehicles per day (depending on location along the corridor). There is considerable variation in Robie Street's cross section, ranging from a constrained two-lane section (Cunard Street to Almon Street) to wider sections with up to five lanes and centre median (Figure 2).

ATTACHMENT C

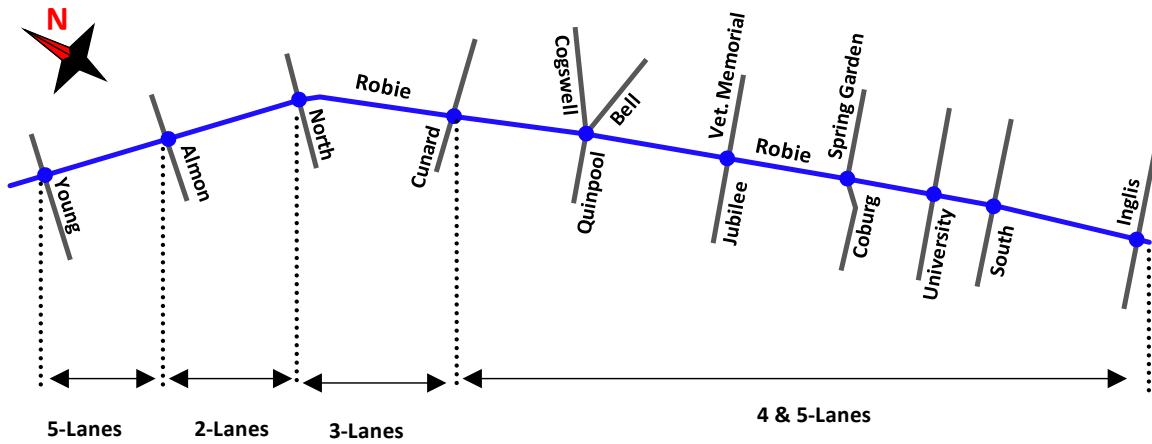

Figure 2: Through traffic lanes on Robie Street (Young Street to Inglis Street)

Hourly weekday distribution of traffic volumes for Robie Street (Almon Street to Young Street) on a typical weekday are illustrated in Figure 3. The daily peak hour volume (approximately 2,000 2-way vehicles) occurs during the afternoon commute period. Throughout the daytime hours, traffic volumes remain relatively balanced, and are less peak-oriented than is typically observed on many commuter-oriented streets.

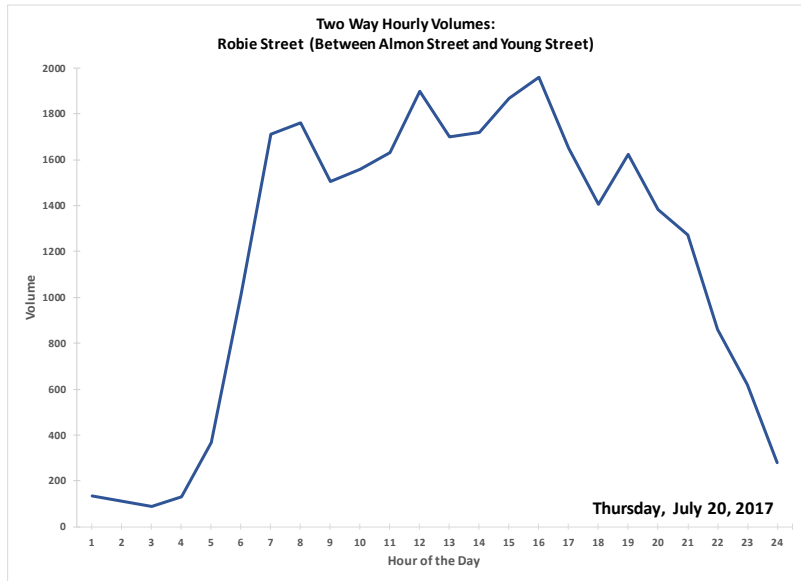

Figure 3: Hourly Traffic Distribution Robie Street (Almon Street to Young Street)

Young Street

Young Street runs east-west between Windsor Street and Gottingen Street, effectively functioning as an extension to the Bayers Road / Highway 102 corridor. It has a 4-5 lane cross section, and accommodates approximately 15,000 vehicles per day.

Proposed Transit Priority Upgrades

Robie Street

Proposed Phase 1 transit priority upgrades on Robie Street include the addition of curbside bus lanes in one or both directions between Young Street and Quinpool Road. The proposed configuration, illustrated in Figure 4, includes repurposing sections of existing curb lanes on Robie Street between Young Street and Quinpool Road as transit only (right turning vehicles would continue to be accommodated at intersections and driveways).

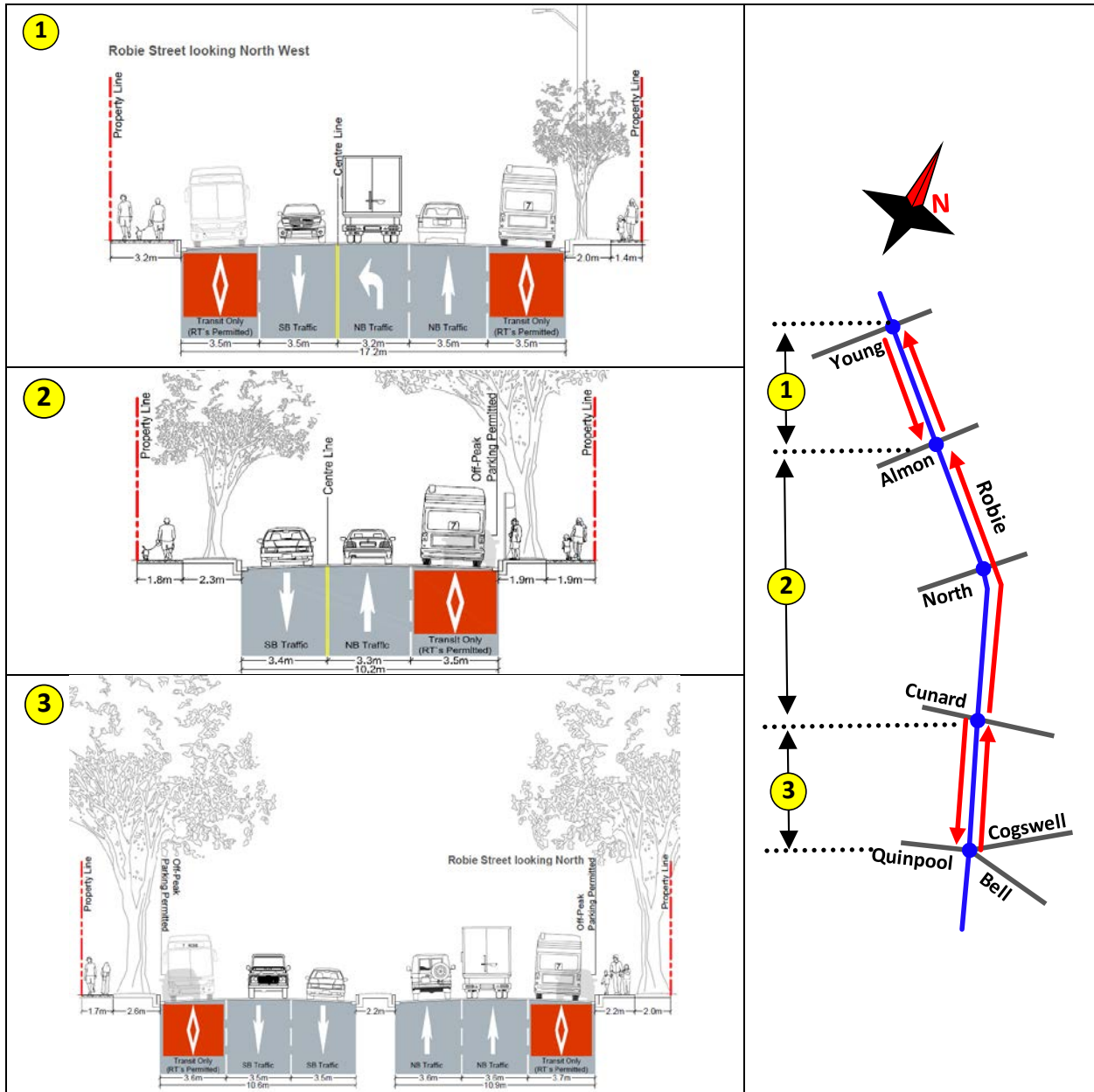

Figure 4: Proposed Phase 1 Transit Priority Upgrades – Typical Mid-Block Cross Sections

ATTACHMENT C

Intersection Configuration Changes

Intersection capacity analysis was completed using Synchro 10 software to evaluate the impact of proposed intersection configuration changes based on AM and PM peak periods. The following sections identify any proposed intersection changes and summarize the results of intersection capacity analysis for AM and PM peak periods for each intersection.

Robie Street – Almon Street Intersection

Proposed changes to the intersection include:

- On the Robie Street NB approach, modify the existing shared through-left / shared through-right configuration to through / right-turn only (except buses).
- Prohibit NB left turn movement to Almon Street. The need to prohibit this movement results from the reduction of the Robie Street northbound through movement to a single lane; maintaining the left turn movement would result in significant delays for through traffic.

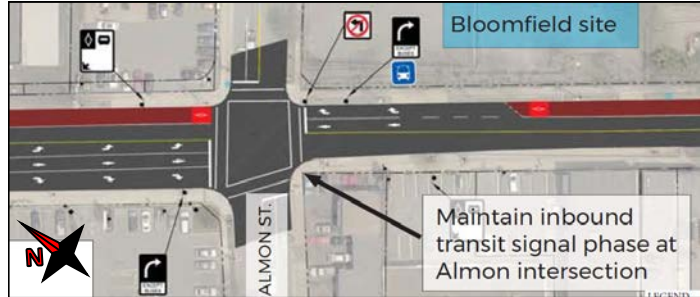

**Figure 5: Proposed Intersection Configuration
Robie Street @ Almon Street**

Intersection performance analysis results are summarized below in Table 1. The Robie Street NB approach is most impacted by the proposed changes, given that the capacity of the through movement is significantly reduced. During the AM peak period, results indicate that despite significant increases in V/C ratio and 95th queues, the intersection operates within acceptable limits. During the PM peak period, conditions worsen considerably, with V/C for the NB through movement increasing from 0.86 to 1.11 and 95th queues extending to over 270m. Prohibition of the NB left turn movement plays an important role in mitigating the impact of the proposed changes. Consideration of the network implications of prohibiting this left turn movement should be made. Additionally, it may be prudent to consider applying the turn restriction only during peak traffic periods.

Table 1: Intersection Performance Analysis Results: Robie Street @ Almon Street

| | | Almon Street | | | | | | Robie Street | | | | | |
|--|---|----------------------|------|-------|----|-------|------|--------------|-------|------|------|------|------|
| | | EB | | | WB | | | NB | | | SB | | |
| | | L | T | R | L | T | R | L | T | R | L | T | R |
| AM Peak | Hourly Volume | 150 | 290 | 50 | 20 | 195 | 45 | 30 | 465 | 15 | 40 | 575 | 10 |
| | Existing Conditions (Page A-1) | Delay | 45.2 | 45.3 | | 37.3 | 5.2 | | 14 | | 15.6 | 35.7 | 2.6 |
| | | V/C | 0.68 | 0.80 | | 0.63 | 0.13 | | 0.46 | | 0.14 | 0.86 | 0.31 |
| | | 95th% Queue | 57.8 | 112.8 | | 66 | 6.1 | | 45 | | 11.5 | 173 | 10.5 |
| | | Int. Delay | 28.3 | | | | | | | | | | |
| | Proposed Phase 1 Configuration (Page A-7) | Delay | 48.3 | 47.8 | | 39.8 | 5.7 | | 20.4 | 1.4 | 15.4 | 33.7 | 2.5 |
| | | V/C | 0.70 | 0.82 | | 0.66 | 0.13 | | 0.68 | 0.02 | 0.14 | 0.84 | 0.3 |
| | | 95th% Queue | 60.2 | 116.4 | | 68.6 | 6.4 | | 106.7 | 1.3 | 11.4 | 172 | 10.3 |
| | | Int. Delay | 30.2 | | | | | | | | | | |
| | PM Peak | Hourly Volume | 190 | 195 | 60 | 15 | 470 | 125 | 30 | 760 | 10 | 20 | 370 |
| Existing Conditions (Page A-4) | | Delay | 43.3 | 18.4 | | 63 | 9.4 | | 34.2 | | 26.4 | 37.1 | 4.5 |
| | | V/C | 0.80 | 0.36 | | 0.96 | 0.27 | | 0.84 | | 0.17 | 0.72 | 0.27 |
| | | 95th% Queue | 68.5 | 55.7 | | 169.3 | 18.1 | | 101.3 | | 9.2 | 99.3 | 12 |
| | | Int. Delay | 36.4 | | | | | | | | | | |
| Proposed Phase 1 Configuration (Page A-10) | | Delay | 118 | 22.6 | | 75.2 | 10 | | 95.2 | 0 | 36 | 29.3 | 3.9 |
| | | V/C | 1.10 | 0.41 | | 1.00 | 0.28 | | 1.11 | 0.02 | 0.32 | 0.60 | 0.24 |
| | | 95th% Queue | 77.2 | 59.9 | | 174.9 | 18.9 | | 272.8 | 0 | 11.1 | 95.7 | 11.2 |
| | | Int. Delay | 64.2 | | | | | | | | | | |

ATTACHMENT C

Robie Street – North Street Intersection

Proposed changes to the North Street intersection are minimal, and include the following:

- On the Robie Street NB approach, retain the existing lane configuration but permit buses to make a through movement from the right-turn only lane. It is recommended that vehicular traffic retain the ability to access the right-turn lane from Willow Street northward; although it reduces the amount of dedicated bus space, retaining capacity for the heavy right turn movement at North Street will also benefit buses by reducing congestion and queuing on the NB approach.
- Modify the north approach from the existing two lanes to include two NB receiving lanes, one for general traffic and one for buses only.

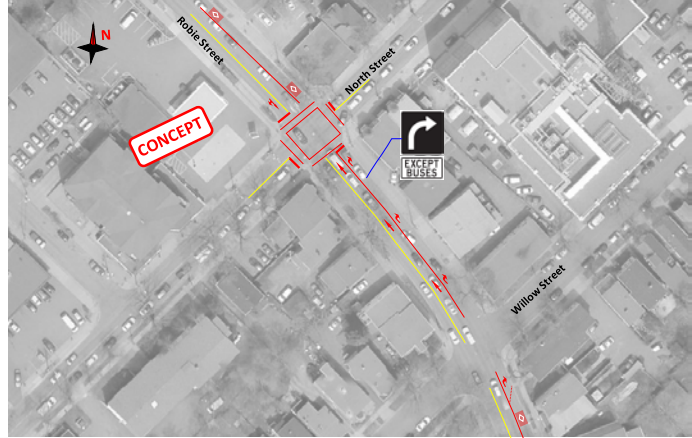

**Figure 6: Proposed Intersection Configuration:
Robie Street @ North Street**

Intersection performance analysis results are summarized below in Table 2. Results indicate that the proposed changes will have minimal operational impact, which is primarily due to the fact that lane configurations (at the intersection) are effectively the same as existing conditions. In reality, the changes will reduce the storage length for right turns, which under existing conditions essentially extends back as far as the Cunard Street intersection (~450m). By designating the curb lane south of Willow Street as a bus-only lane, the effective right turn storage length will be reduced to approximately 75m.

Based on field observations, it is noted that during the afternoon peak period, operation on the NB approach varies considerably from day to day and is more dependent on queue spillback on North Street than on the operation of the Robie Street – North Street intersection. Approximately 2/3 of NB traffic are through movements at North Street, and observations indicate that a significant portion of this through traffic merges into the leftmost lane long before the North Street intersection, in many cases as far south as the North Common.

Table 2: Intersection Performance Analysis Results: Robie Street @ North Street

| | | North Street | | | | | | Robie Street | | | | | | | |
|----------------|--|---------------|------|---|-----|-------|---|--------------|-------|------|-------|-----|---|-----|----|
| | | EB | | | WB | | | NB | | | SB | | | | |
| | | L | T | R | L | T | R | L | T | R | L | T | R | | |
| AM Peak | | Hourly Volume | | 0 | 375 | 25 | 0 | 420 | 10 | 0 | 470 | 110 | 0 | 565 | 10 |
| | Existing Conditions (Page A-2) | Delay | 47.8 | | | 42.8 | | | 20.9 | 2.9 | 26.5 | | | | |
| | | V/C | 0.89 | | | 0.86 | | | 0.71 | 0.18 | 0.77 | | | | |
| | | 95th% Queue | 118 | | | 115.7 | | | 132 | 8.4 | 159.8 | | | | |
| | | Int. Delay | 31.7 | | | | | | | | | | | | |
| | Proposed Phase 1 Configuration (Page A-8) | Delay | 47.8 | | | 42.6 | | | 23.8 | 7.3 | 26.5 | | | | |
| | | V/C | 0.89 | | | 0.86 | | | 0.71 | 0.18 | 0.77 | | | | |
| | | 95th% Queue | 118 | | | 115 | | | 83.2 | 10.9 | 159.8 | | | | |
| | | Int. Delay | 32.6 | | | | | | | | | | | | |
| PM Peak | | Hourly Volume | | 0 | 345 | 25 | 0 | 445 | 20 | 0 | 670 | 375 | 0 | 525 | 30 |
| | Existing Conditions (Page A-5) | Delay | 36.6 | | | 50.4 | | | 14 | 48.5 | 17.9 | | | | |
| | | V/C | 0.76 | | | 0.91 | | | 0.79 | 0.98 | 0.64 | | | | |
| | | 95th% Queue | 95.6 | | | 139.6 | | | 179.2 | 125 | 110.6 | | | | |
| | | Int. Delay | 30.6 | | | | | | | | | | | | |
| | Proposed Phase 1 Configuration (Page A-11) | Delay | 36.6 | | | 50.4 | | | 30.7 | 54.3 | 17.9 | | | | |
| | | V/C | 0.76 | | | 0.91 | | | 0.79 | 0.98 | 0.64 | | | | |
| | | 95th% Queue | 95.6 | | | 139.6 | | | 127 | 81.1 | 110.6 | | | | |
| | | Int. Delay | 36.1 | | | | | | | | | | | | |

ATTACHMENT C

Robie Street – Cunard Street Intersection

Proposed changes to the intersection, illustrated in Figure 7, include:

- **Robie Street NB Approach:** Convert curb lane to right-turn only (except buses), reducing the number of through lanes from two to one. Significantly reduce the size of the channelized right turn (size to be refined during detailed design).
- **Cunard Street WB Approach:** Modify the east intersection leg to realign the EB movement, as illustrated in the concept presented in Figure 7. Remove WB right turn lane.
- North of Cunard Street, designate the NB receiving curb lane as a dedicated bus lane.
- South of Cunard Street, designate the SB receiving curb lane as a dedicated bus lane.
- Removal of the NB protected only left turn phase may be possible with potential design improvements to address existing issues (sight lines, vehicle path overlap). This would provide more efficient signal operation.

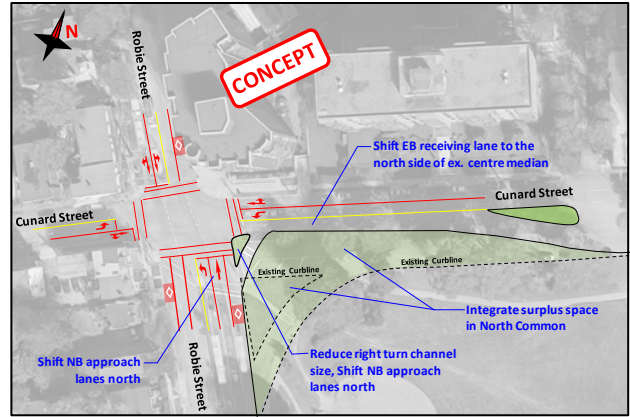

Figure 7: Proposed Intersection Configuration – Robie Street @ Cunard Street

Intersection performance analysis results are summarized below in Table 3. Results indicate the following:

- During the AM peak period, operational changes are relatively insignificant. Operations on the Robie Street NB approach will degrade but remain within acceptable limits. The SB approach may have slight improvements over existing conditions.
- Operational changes are more pronounced during the PM peak period, particularly on the Robie Street NB approach and Cunard Street WB approach, where through movement V/C exceeds 1.0 and 95th queue lengths extend considerably.
- Lane utilization on the northbound approach is currently imbalanced, with approximately 70% of through traffic using the leftmost through lane (anticipating a difficult downstream merge movement to continue north on Robie Street at North Street). Given this lane imbalance, it is expected that in reality loss of the rightmost through lane will be less critical than indicated in the results.

Table 3: Intersection Performance Analysis Results: Robie Street @ Cunard Street

| | | Cunard Street | | | | | | Robie Street | | | | | |
|--|----------------------|---------------|-------|------|-------|------|------|--------------|------|----|-------|-----|----|
| | | EB | | | WB | | | NB | | | SB | | |
| | | L | T | R | L | T | R | L | T | R | L | T | R |
| Existing Conditions (Page A-3) | Hourly Volume | 10 | 410 | 90 | 40 | 160 | 40 | 50 | 470 | 20 | 75 | 655 | 10 |
| | Delay | 19 | 145 | 38 | 23 | 5.2 | 56 | 24.8 | | | 53 | | |
| | V/C | 0.04 | 1.22 | 0.45 | 0.35 | 0.13 | 0.5 | 0.51 | | | 1.02 | | |
| | 95th% Queue | 4.7 | 183.6 | 18 | 40 | 6.1 | 24 | 56.2 | | | 122.1 | | |
| Proposed Phase 1 Configuration (Page A-9) | Int. Delay | 65.1 | | | | | | | | | | | |
| | Delay | 19.1 | 147.2 | 38 | 23.7 | | 20 | 25 | 1.3 | | 40.9 | | |
| | V/C | 0.04 | 1.22 | 0.5 | 0.45 | | 0.3 | 0.71 | 0.04 | | 0.83 | | |
| | 95th% Queue | 4.7 | 183.6 | 19 | 47.9 | | 15 | 109 | 1.4 | | 102 | | |
| Existing Conditions (Page A-6) | Hourly Volume | 20 | 300 | 60 | 65 | 475 | 75 | 50 | 760 | 60 | 55 | 545 | 50 |
| | Delay | 25.4 | 35.8 | 26 | 38 | 9.4 | 51 | 29.4 | | | 39.7 | | |
| | V/C | 0.21 | 0.77 | 0.32 | 0.82 | 0.27 | 0.4 | 0.74 | | | 0.92 | | |
| | 95th% Queue | 9.1 | 103.6 | 21 | 135 | 5.7 | 21 | 98.9 | | | 108.6 | | |
| Proposed Phase 1 Configuration (Page A-12) | Int. Delay | 34.1 | | | | | | | | | | | |
| | Delay | 40.2 | 40.8 | 28 | 73.9 | | 12 | 45 | 5.5 | | 42.9 | | |
| | V/C | 0.35 | 0.81 | 0.4 | 1.03 | | 0.18 | 0.96 | 0.1 | | 0.93 | | |
| | 95th% Queue | 11.3 | 110.2 | 22 | 179.8 | | 10 | 219 | 7.9 | | 100.8 | | |
| | | 47.9 | | | | | | | | | | | |

Young Street

Proposed Phase 1 transit priority upgrades on Young Street include re-designation of the westbound curbside vehicle lane as a dedicated bus lane between Robie Street and Windsor Street (right turning vehicles would continue to be accommodated at intersections and driveways). A typical cross section of the proposed configuration is illustrated in Figure 8.

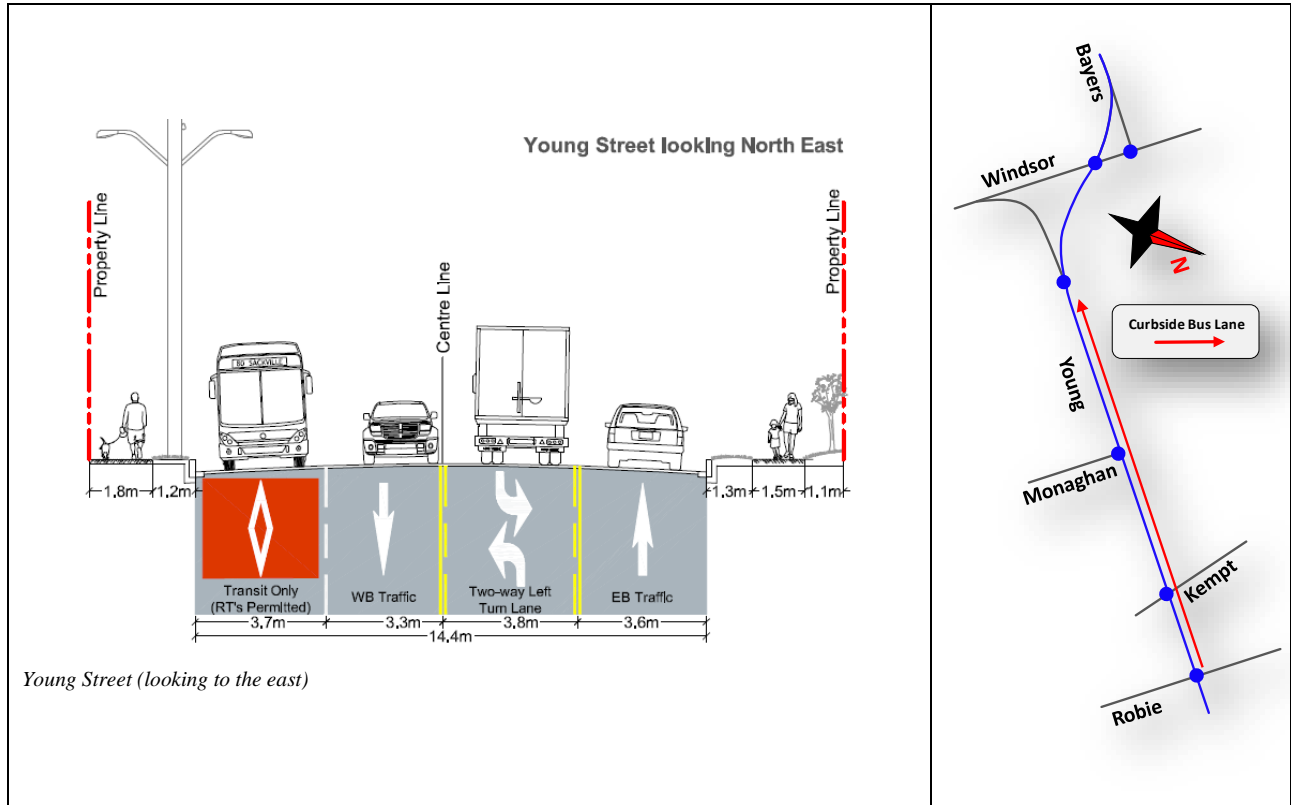

Figure 8: Proposed Street Configuration Options – Young Street (Windsor Street to Kempt Road)

ATTACHMENT C

Intersection Configuration Changes

Intersection capacity analysis was completed using Synchro 10 software to evaluate the impact of proposed intersection configuration changes based on AM and PM peak periods. The following sections identify any proposed intersection changes and summarize the results of intersection capacity analysis for AM and PM peak periods for each intersection.

Young Street: Robie Street to Kempt Road

The proposed configuration for the Young Street intersections at Robie Street and Kempt Road, illustrated below in Figure 9, includes the following modifications:

- Reconfigure the section of Young Street between Robie Street and Kempt Road to include:
 - A westbound bus lane in the receiving curb lane;
 - Right-turn only (except buses) on the approach to Kempt Road;
 - A westbound left turn lane at the Esso Driveway / Kempt Road intersection (by reassigning a portion of the existing EB left turn lane at Robie Street);
- Reconfigure the existing through-left lane on the Young Street WB approach to Robie Street to a left turn lane;
- Convert the Young Street WB receiving curb lane west of Kempt Road to a dedicated bus lane.
- Modify the Robie Street SB through-right lane to a right-turn lane, reducing the number of SB through lanes from two to one (to accommodate the bus lane that is introduced south of Young Street).

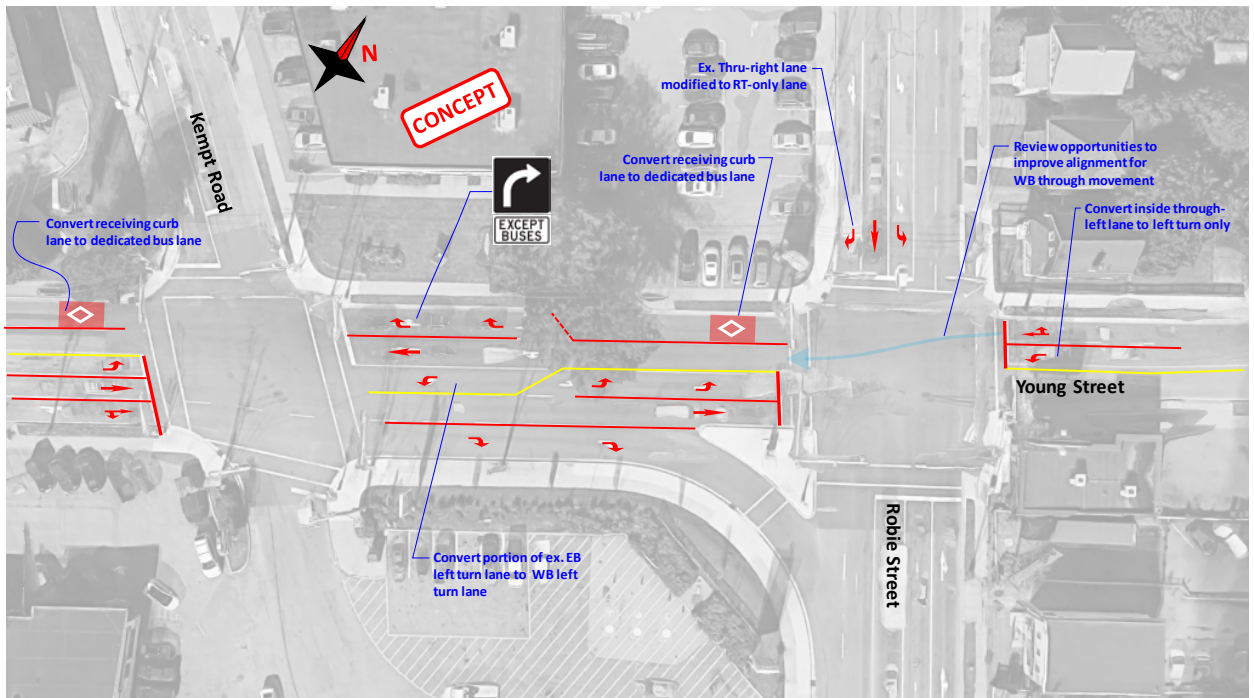

Figure 9: Proposed Configuration -- Young Street (Robie Street to Kempt Road)

Intersection performance analysis results for the Young Street – Robie Street and Young Street – Kempt Road intersections are summarized in Table 4 and Table 5, respectively. Key results include the following:

- At the Young Street – Robie Street intersection, reduction in through lane capacity on the Young Street WB approach and the Robie Street SB approach result in significant increases to key criteria including V/C ratio, delay, and queue length. Operational impacts are particularly pronounced for the Robie Street SB through movement, with V/C ratio during the AM peak hour increasing from 0.67 to above 1.0.

ATTACHMENT C

- The analysis indicates that impacts at the Young Street – Kempt Road intersection are relatively insignificant, though the results suggest that upstream metering at the Robie Street intersection may have an impact on WB traffic volumes flowing into the intersection.

Table 4: Intersection Performance Analysis Results: Young Street @ Robie Street

| | | Robie Street | | | | | | Young Street | | | | | |
|--|--|---------------|------|------|------|------|------|--------------|------|------|-------|-------|-----|
| | | NB | | | SB | | | EB | | | WB | | |
| | | L | T | R | L | T | R | L | T | R | L | T | R |
| AM Peak | Hourly Volume | 80 | 495 | 20 | 60 | 735 | 80 | 100 | 405 | 115 | 20 | 260 | 20 |
| | Existing Conditions (Attachment E, Page F-3) | Delay | 28.7 | 18 | 17.8 | 21 | 14.4 | 24.8 | 4.1 | 20.5 | 41.2 | | |
| | | V/C | 0.53 | 0.40 | 0.24 | 0.67 | 0.41 | 0.79 | 0.25 | 0.13 | 0.79 | | |
| | | 95th% Queue | 19.5 | 37.3 | 16.3 | 85.5 | 11.6 | 109 | 3.9 | 5.6 | 95.5 | | |
| | | Int. Delay | 22.5 | | | | | | | | | | |
| | Proposed Phase 1 Configuration (Attachment E, Page F-15) | Delay | 23.6 | 15 | 23.1 | 87.3 | 2.7 | 30.2 | 60.7 | 9.6 | 40.4 | 84.3 | |
| | | V/C | 0.49 | 0.33 | 0.22 | 1.08 | 0.13 | 0.39 | 0.75 | 0.23 | 0.16 | 0.96 | |
| | | 95th% Queue | 20.4 | 47 | 19.8 | 275 | 6.4 | 29 | 138 | 5.6 | 11.6 | 121.9 | |
| | | Int. Delay | 53.4 | | | | | | | | | | |
| | PM Peak | Hourly Volume | 165 | 850 | 15 | 35 | 420 | 75 | 160 | 325 | 200 | 15 | 340 |
| Existing Conditions (Attachment E, Page F-5) | | Delay | 25.6 | 14.2 | 32.6 | 20.4 | 26.6 | 17.3 | 4.1 | 24.6 | 63.1 | | |
| | | V/C | 0.77 | 0.81 | 0.40 | 0.49 | 0.67 | 0.51 | 0.34 | 0.07 | 0.95 | | |
| | | 95th% Queue | 13.8 | 36.7 | 15 | 48.3 | 34.8 | 45.3 | 8.5 | 7.1 | 140.5 | | |
| | | Int. Delay | 24.1 | | | | | | | | | | |
| Proposed Phase 1 Configuration (Attachment E, Page F-17) | | Delay | 25.9 | 22.7 | 30.7 | 60.2 | 3.4 | 29.5 | 19.9 | 5.1 | 25.2 | 56.2 | |
| | | V/C | 0.66 | 0.65 | 0.28 | 0.94 | 0.17 | 0.64 | 0.48 | 0.25 | 0.06 | 0.9 | |
| | | 95th% Queue | 32.2 | 85.3 | 14.3 | 136 | 6.3 | 40.2 | 55.2 | 16.1 | 7.2 | 134.3 | |
| | | Int. Delay | 32.2 | | | | | | | | | | |

Table 5: Intersection Performance Analysis Results: Young Street @ Kempt Road

| | | Kempt Road | | | | | | Young Street | | | | | |
|--|--|---------------|------|------|------|------|------|--------------|------|------|-----|-----|-----|
| | | NB | | | SB | | | EB | | | WB | | |
| | | L | T | R | L | T | R | L | T | R | L | T | R |
| AM Peak | Hourly Volume | 60 | 55 | 45 | 125 | 70 | 60 | 35 | 450 | 55 | 45 | 305 | 70 |
| | Existing Conditions (Attachment E, Page F-2) | Delay | 14 | 17.2 | 9.3 | 16.7 | 23.5 | 30.9 | | | | | |
| | | V/C | 0.29 | 0.29 | 0.2 | 0.15 | 0.55 | 0.78 | | | | | |
| | | 95th% Queue | 29.9 | 28.3 | 19.1 | 9.9 | 53.2 | 33.4 | | | | | |
| | | Int. Delay | 22.6 | | | | | | | | | | |
| | Proposed Phase 1 Configuration (Attachment E, Page F-14) | Delay | 59.1 | 40.3 | 30.8 | 32.7 | 20.8 | 22.2 | 14.3 | 19.6 | 5.9 | | |
| | | V/C | 0.52 | 0.52 | 0.39 | 0.35 | 0.08 | 0.3 | 0.12 | 0.32 | 0.1 | | |
| | | 95th% Queue | 27 | 32.4 | 34 | 37.3 | 9.9 | 62.3 | 5.2 | 29.6 | 0.1 | | |
| | | Int. Delay | 25.1 | | | | | | | | | | |
| | PM Peak | Hourly Volume | 105 | 65 | 25 | 210 | 60 | 90 | 160 | 450 | 200 | 20 | 445 |
| Existing Conditions (Attachment E, Page F-4) | | Delay | 22.6 | 29.3 | 8.6 | 26.8 | 17.8 | 39.5 | | | | | |
| | | V/C | 0.47 | 0.62 | 0.27 | 0.65 | 0.57 | 0.81 | | | | | |
| | | 95th% Queue | 45.5 | 56.2 | 19.5 | 35.5 | 60.6 | 39.1 | | | | | |
| | | Int. Delay | 26 | | | | | | | | | | |
| Proposed Phase 1 Configuration (Attachment E, Page F-17) | | Delay | 48.6 | 27.6 | 24.6 | 23.4 | 26.3 | 13.2 | 7.1 | 12 | 1.5 | | |
| | | V/C | 0.63 | 0.33 | 0.52 | 0.33 | 0.59 | 0.46 | 0.08 | 0.53 | 0.2 | | |
| | | 95th% Queue | 34.1 | 24.4 | 44.7 | 35 | 54.9 | 53.4 | 1.3 | 25.6 | 0 | | |
| | | Int. Delay | 17.8 | | | | | | | | | | |

ATTACHMENT C

Young Street: Monaghan Drive to Halifax Forum

The section of Young Street west of Monaghan Drive (extending approximately to the Halifax Forum – ~200m) is proposed to be reconfigured to include a WB dedicated bus lane, as well as two through lanes (one in each direction) and a center two-way left turn lane (TWLTL).

Young Street accommodates average annual weekday traffic (AADT) of approximately 15,000 vehicles per day (vpd). There is a range of guidance related to the suitability of applying a road diet approach to 4-lane, undivided roadways to add facilities for transit and active transportation. The US Federal Highway Administration (FHWA) advises that roadways with AADT less than 20,000 vpd may be candidates for road diets using TWLT configuration. Other research has suggested upper limits ranging from 15,000 to 24,000 vpd¹.

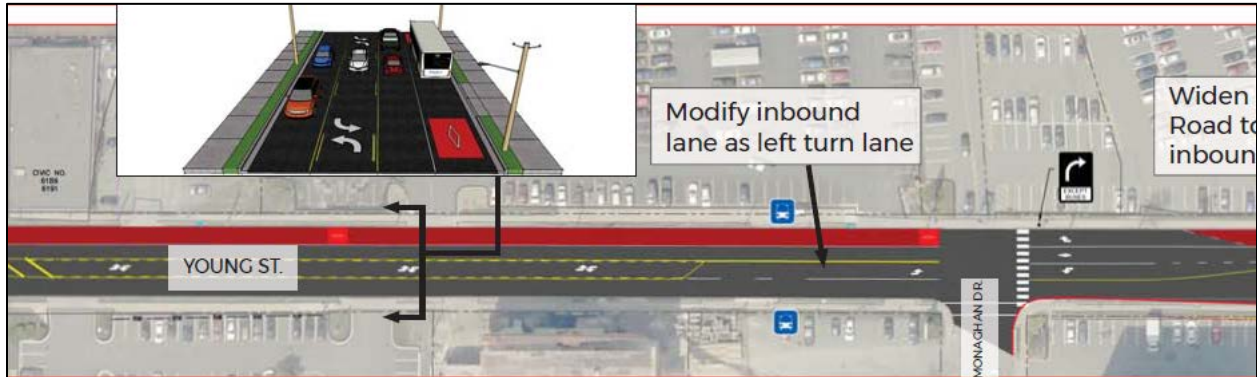

Figure 10: Proposed Configuration - Young Street (Monaghan Drive to Halifax Forum)

Concluding Thoughts

Staff have completed an analysis of the traffic impacts associated with the proposed Phase 1 transit priority upgrades on Robie Street and Young Street. These findings supplement the analyses that were completed by WSP for the various options considered for the Robie Street / Young Street Transit Priority Corridor

The proposed Phase 1 design for Robie Street and Young Street, which will reallocate existing traffic lanes on both streets to provide dedicated lanes for transit, will reduce traffic capacity and therefore impact operations for traffic during peak periods. The objective of this Traffic Impact Analysis has been to quantify these impacts at key intersections to enable a better understanding of the necessary trade-offs resulting from prioritization of transit on the corridor.

Overall, the proposed lane configuration changes, which reduce roadway traffic capacity both mid-block and at intersections, are expected to negatively impact traffic operations on the Robie Street corridor. Traffic analysis based on weekday morning and afternoon peak periods indicates that key metrics including vehicle delay and queue length will increase for some affected movements, in some cases significantly, relative to existing conditions. Analysis also indicates that based on current traffic demand during peak periods, traffic volumes will approach or exceed the amount of available capacity for some key movements. As a result, congestion on the corridor will be expected to worsen relative to existing conditions.

Resulting traffic congestion may encourage motorists to consider other options such as (i) shifting to other modes (i.e. transit, active transportation), (ii) changing commute times earlier or later in the day, (iii) diversion to other

¹ Road Diet Informational Guide (Federal Highway Administration, 2014)

ATTACHMENT C

routes. It is difficult to predict how motorists will react to the proposed changes; however, these are the types of behaviour shifts that are fundamental to the success of the IMP's transportation planning objectives.

On-Street Parking Review

Robie Street Transit Priority Corridor

Prepared by:

Strategic Transportation Planning
June 2019

Table of Contents

| | |
|---|-----------|
| Introduction | 3 |
| Background | 3 |
| Objective | 3 |
| Existing On-Street Parking..... | 3 |
| Existing Parking Supply | 3 |
| Existing Parking Utilization..... | 8 |
| Existing Loading Supply..... | 10 |
| Existing Loading Demand | 11 |
| Proposed Changes to Parking and Loading..... | 12 |
| Proposed Phase 1 Transit Priority Upgrades..... | 12 |
| Parking and Loading Impacts | 13 |
| Concluding Thoughts | 13 |

Introduction

Background

Halifax Regional Municipality (HRM) is currently in the process of planning and designing for proposed transit priority upgrades to Robie Street. Staff have recommended that the project be implemented in phases, the first of which would include installation of curbside bus lanes on the following segments of Robie Street (Figure 1):

- Young Street to Almon Street: Northbound / southbound bus lanes
- Almon Street to Cunard Street: Northbound bus lane
- Cunard Street to Quinpool Road: Northbound / southbound bus lanes

Proposed Phase 1 changes do not require widening but do necessitate reconfiguration of existing curb-to-curb space that is currently used for traffic lanes and parking / loading. Accordingly, there are areas along Robie Street where it will be necessary to remove existing on-street parking spaces and prohibit curb access for loading activities. Recognizing the importance of both activities to businesses and residents in the area, staff completed an investigation of existing on-street parking on the affected sections of Robie Street that included an inventory of curbside uses, review of current parking utilization, and quantification of the impacts to these uses expected to result from the implementation of transit priority upgrades.

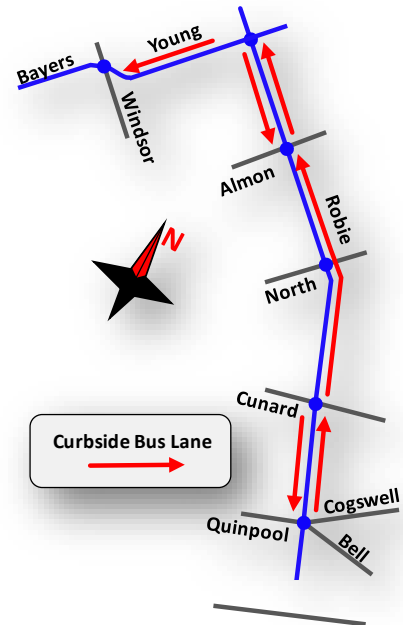

Figure 1: Proposed Phase 1 Transit Priority Upgrades

Objective

The objective of the on-street parking review is to develop a better understanding of the current parking and loading conditions on Robie Street and the impact of the proposed transit lanes on both activities.

Existing On-Street Parking

Existing Parking Supply

Curb access on Robie Street currently varies along the corridor, generally including on-street parking (time-restricted and unrestricted), accessible parking, and bus stops. There are also several locations where curb access is prohibited due to insufficient width or due to proximity to intersections, crosswalks, and bus stops. There are approximately 58 parking spaces on Robie Street between Quinpool Road and Almon Street, as summarized in Table 1 and Figure 2. There are no parking meters or taxi stands along this segment; parking time restrictions vary from 15-60 minutes. Figures 3 to 5 summarize curbside access along Robie Street and the surrounding streets, including the number, type and location of parking spaces.

ATTACHMENT D

Table 1: Existing On-Street Parking Supply

| | | Unrestricted Parking | Peak Restricted (7-9AM) (4-6PM) | | Accessible Parking | Total |
|--------------------------------|------|----------------------|---------------------------------|----|--------------------|-------|
| Almon Street to North Street | East | - | - | 20 | - | 20 |
| | West | - | - | - | - | 0 |
| North Street to Cunard Street | East | - | - | - | 2 | 1 |
| | West | - | - | - | - | 0 |
| Cunard Street to Quinpool Road | East | 23 | - | - | - | 23 |
| | West | - | 13 | - | - | 13 |
| Total | East | 23 | - | 20 | 2 | 45 |
| | West | - | 13 | - | - | 13 |



Figure 2 – Existing On-Street Parking Supply

ATTACHMENT D

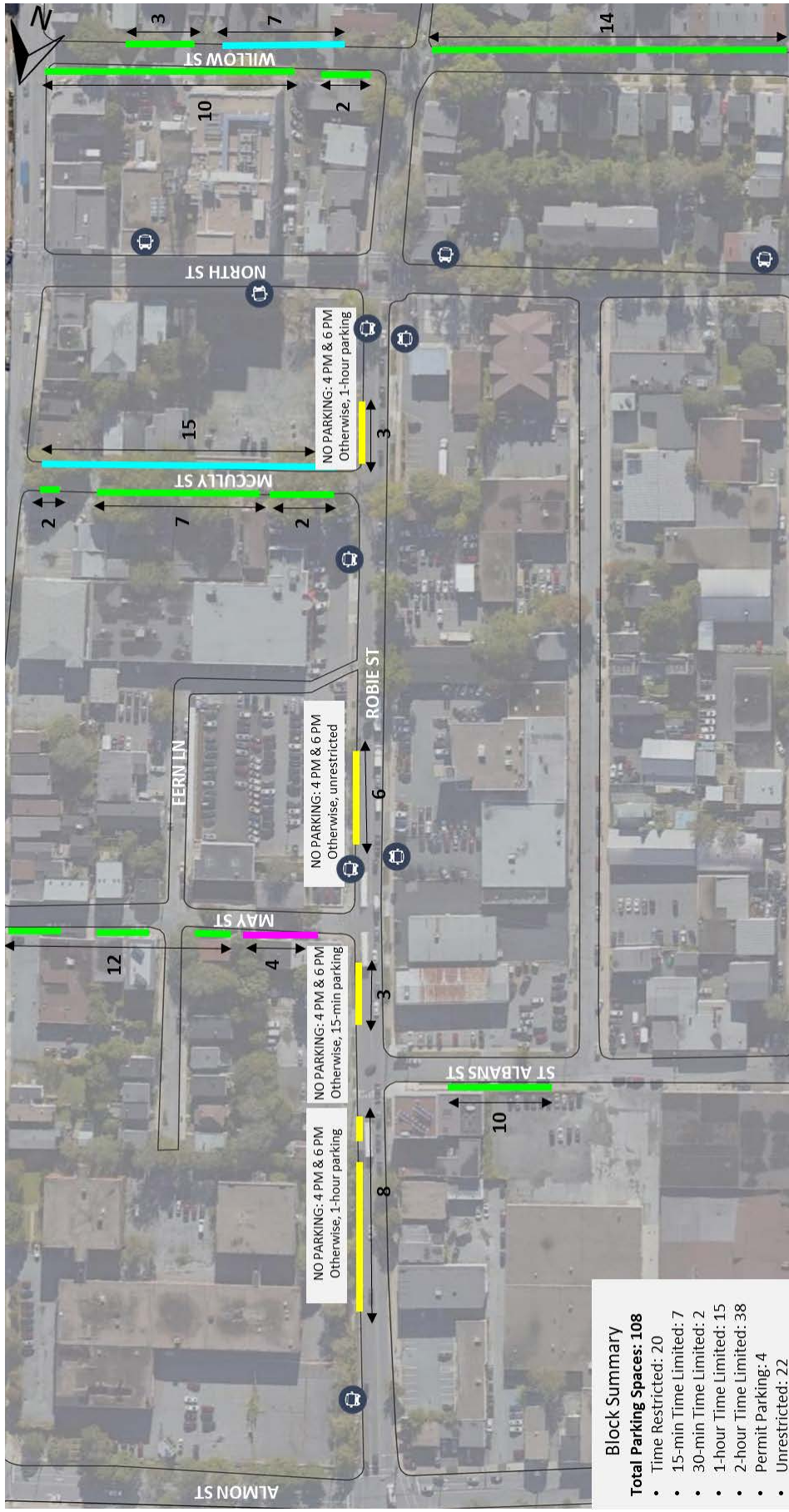

Figure 3 – Existing Parking Conditions – Robie Street from Almon Street to Willow Street



ATTACHMENT D

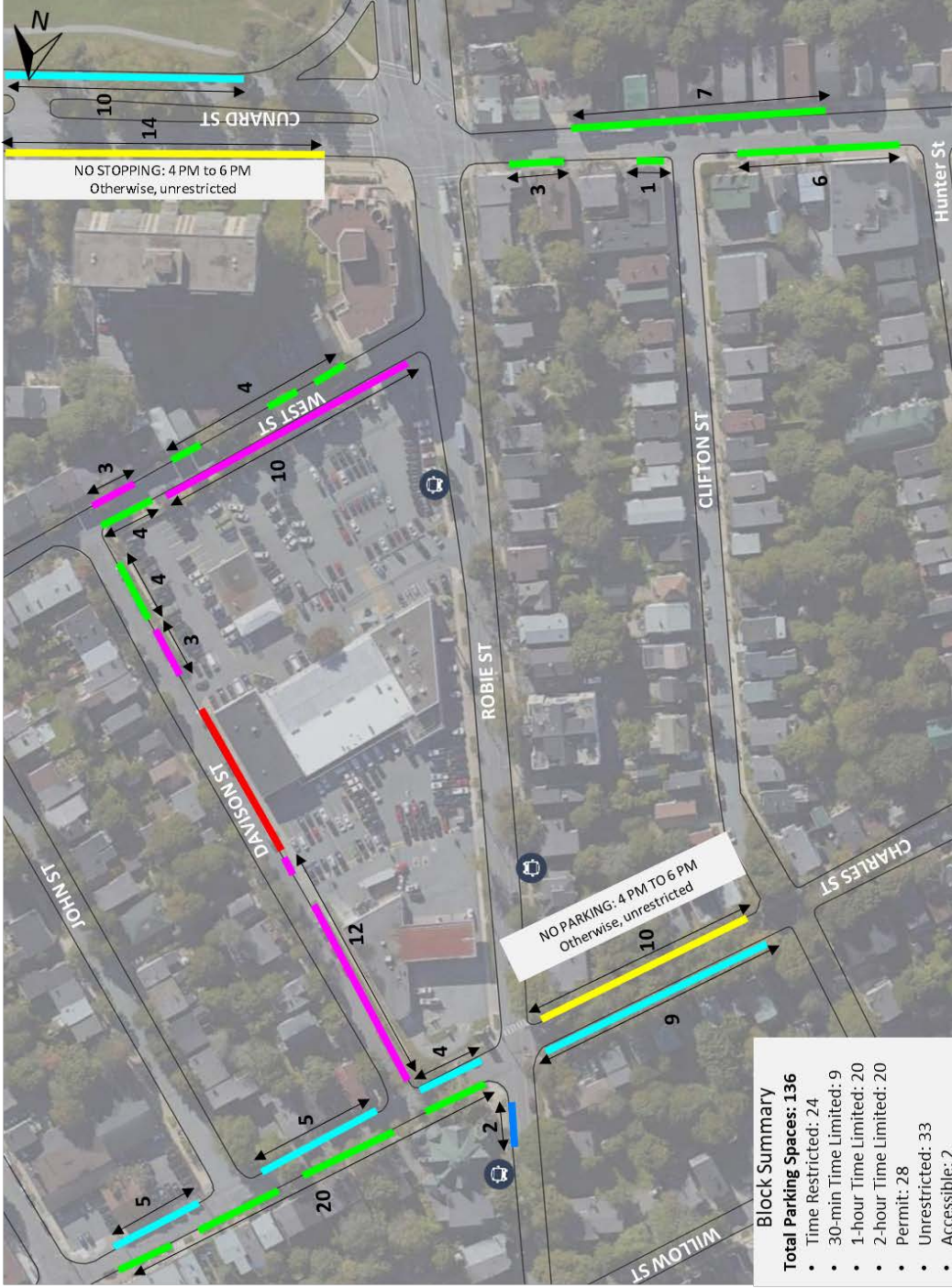

Figure 4 – Existing Parking Conditions – Robie Street from Willow Street to Cunard Street

- █ Time Limited Parking
- █ Permit Parking
- █ Unrestricted Parking
- █ Accessible Parking
- █ Time Restricted Parking
- █ Loading Zone

ATTACHMENT D

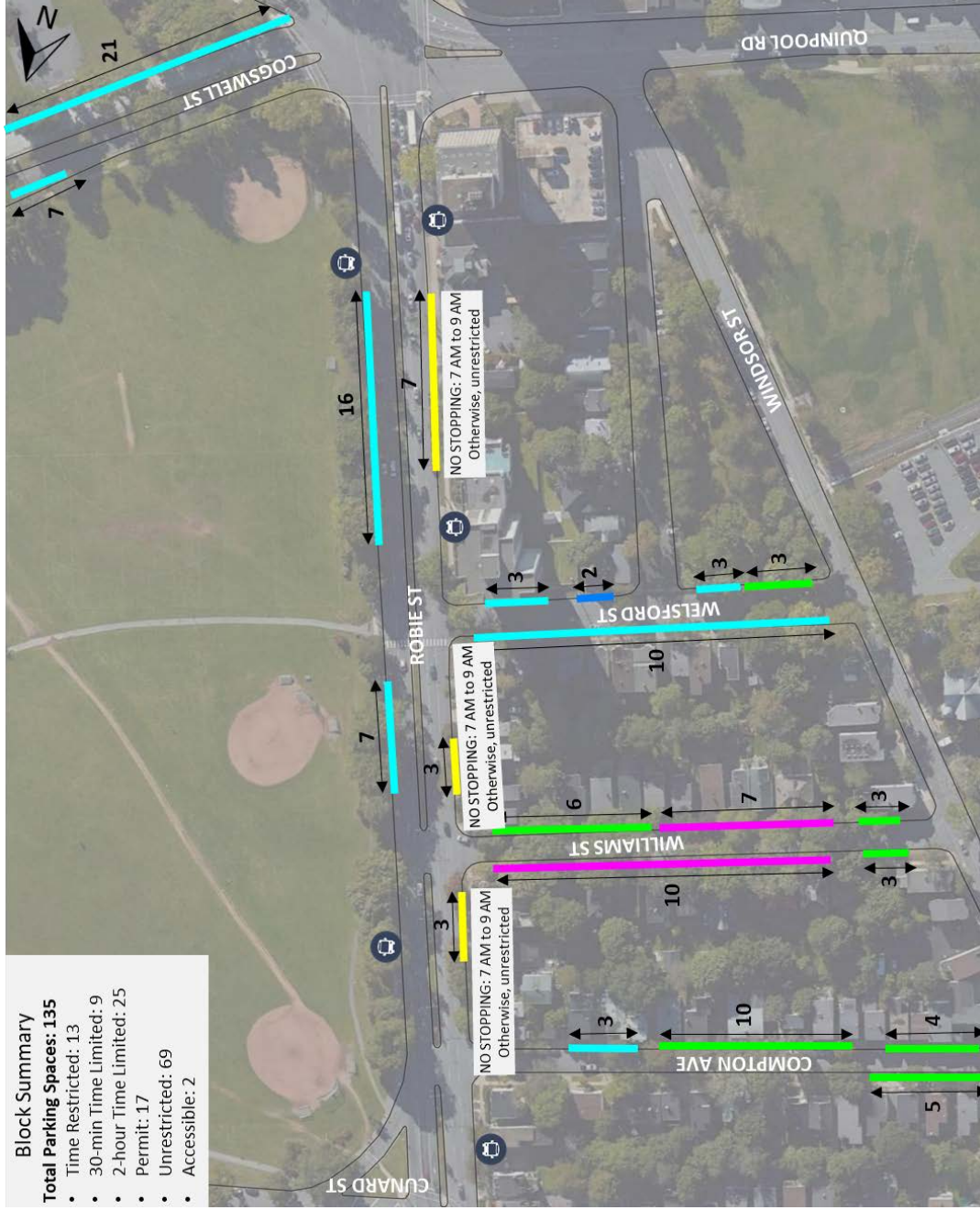

Figure 5 – Existing Parking Conditions – Robie Street from Cunard Street to Quinpool Road/Cogswell Street

- Time Limited Parking
- Permit Parking
- Time Restricted Parking
- Loading Zone
- Unrestricted Parking
- Accessible Parking

ATTACHMENT D

Existing Parking Utilization

Parking utilization observations were completed on Robie Street (Quinpool Road to Almon Street) and immediately adjacent streets over a 7-hour period on Wednesday, May 2nd and Thursday, May 3rd, 2018. Each parking space in the Study Area was observed every 30 minutes throughout the study period, enabling understanding of both parking utilization and turnover.

Results of the parking utilization observations, which are summarized below in Table 2 and Figure 6, indicate the following:

- Average parking occupancy on Robie Street was approximately 66% between 9am and 4pm. Spaces north of McCully Street and south of Cunard Street had very high utilization, exceeding 80% throughout the day.
- Average parking duration was 244 minutes (>4 hours), indicating very low turnover. The section of Robie Street with the highest turnover was on the west side between Cunard Street and Quinpool Road, with an average parking duration of 144 minutes. Turnover was lowest on the section of Robie Street between Cogswell Street and Welsford Street, where the average parking duration was 385 minutes (>6 hours).
- There are approximately 321 on-street parking spaces on the immediately adjacent streets. The aggregated average parking utilization for all side streets was 73% and the average duration was 223 minutes.

Table 2: Existing On-Street Parking Supply

| | | On-Street Parking Spaces | Average Utilization (7AM – 4PM) | Average Duration (7AM – 4PM) |
|---|------|-------------------------------------|--|---|
| Almon Street to North Street | East | 20 | 54% | 158 minutes |
| | West | 0 | - | - |
| North Street to Cunard Street | East | 2 | - | - |
| | West | 0 | - | - |
| Cunard Street to Quinpool Road | East | 23 | 93% | 380 minutes |
| | West | 13 | 38% | 144 minutes |
| Total | | 58 | 66% | 244 minutes |

ATTACHMENT D



Figure 6 – Summary of Parking Utilization on Robie Street and Adjacent Side Streets

Existing Loading Supply

There are no formally signed loading zones on Robie Street; however, the Nova Scotia *Motor Vehicle Act* allows stopping temporarily within a “No Parking” zone while engaged in loading or unloading. As a result, “No Parking” zones effectively operate as de facto loading areas.

The location and approximate amount (length in metres) of total “No Parking” areas on Robie Street is illustrated in Figure 7. In several locations, AM/PM peak period “No Stopping” restrictions reduce the amount of space available for loading activities.



Figure 7 – Summary of Existing “No Parking” areas (in meters) on Robie Street

Existing Loading Demand

Staff completed a survey of Robie Street businesses to better understand current loading operations. The survey included questions related to typical loading activities, including the time of day, frequency, location, and vehicle type. Key findings included:

- The majority of the 32 businesses surveyed (87%) indicated that they do not conduct loading activities on Robie Street (Figure 8). Most of these businesses conduct loading off-street (55%) or via side streets (29%). Two businesses (6%) reported not receiving any deliveries.
- Four of the businesses surveyed indicated that they currently conduct loading activities from Robie Street. Of these four, three indicated that they receive deliveries 1-3 days per week, with typical delivery duration of 15 minutes or less. One business reported receiving deliveries multiple times daily for a duration longer than one hour, with all deliveries occurring during the weekend, evenings or early morning.

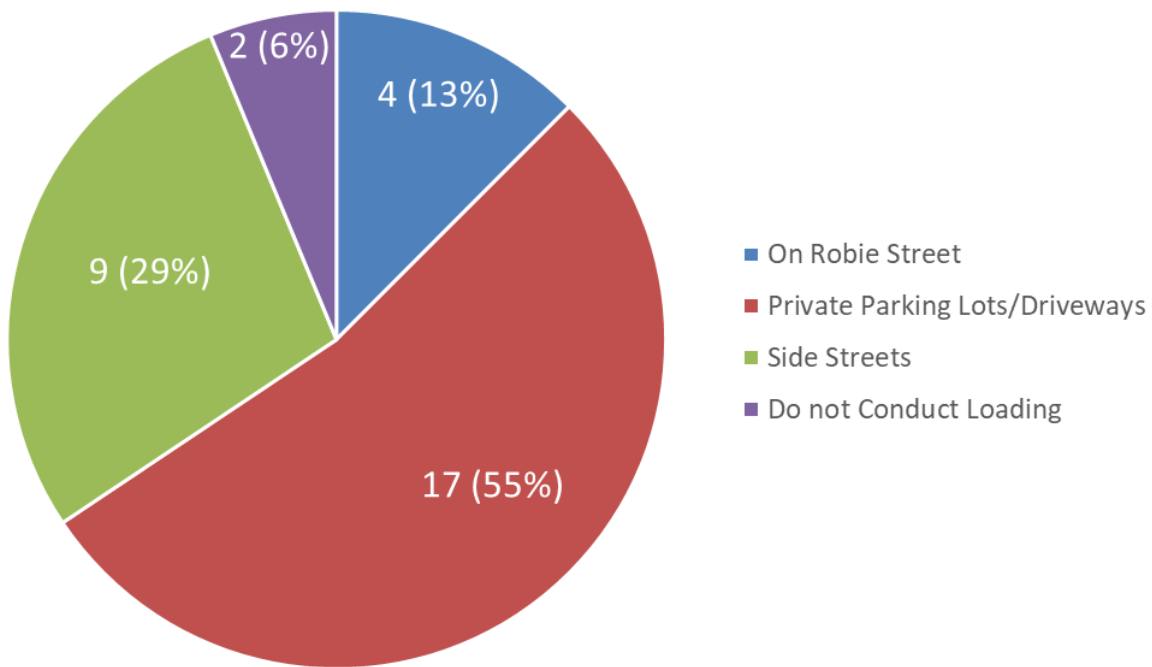

Figure 8 – Location of Loading Activities based on Survey Results

Proposed Changes to Parking and Loading

Proposed Phase 1 Transit Priority Upgrades

Proposed Phase 1 transit priority upgrades on Robie Street include the addition of curbside bus lanes in one or both directions between Young Street and Quinpool Road. The proposed configuration is summarized in Table 3.

Table 3: Proposed Phase 1 Transit Priority Upgrades

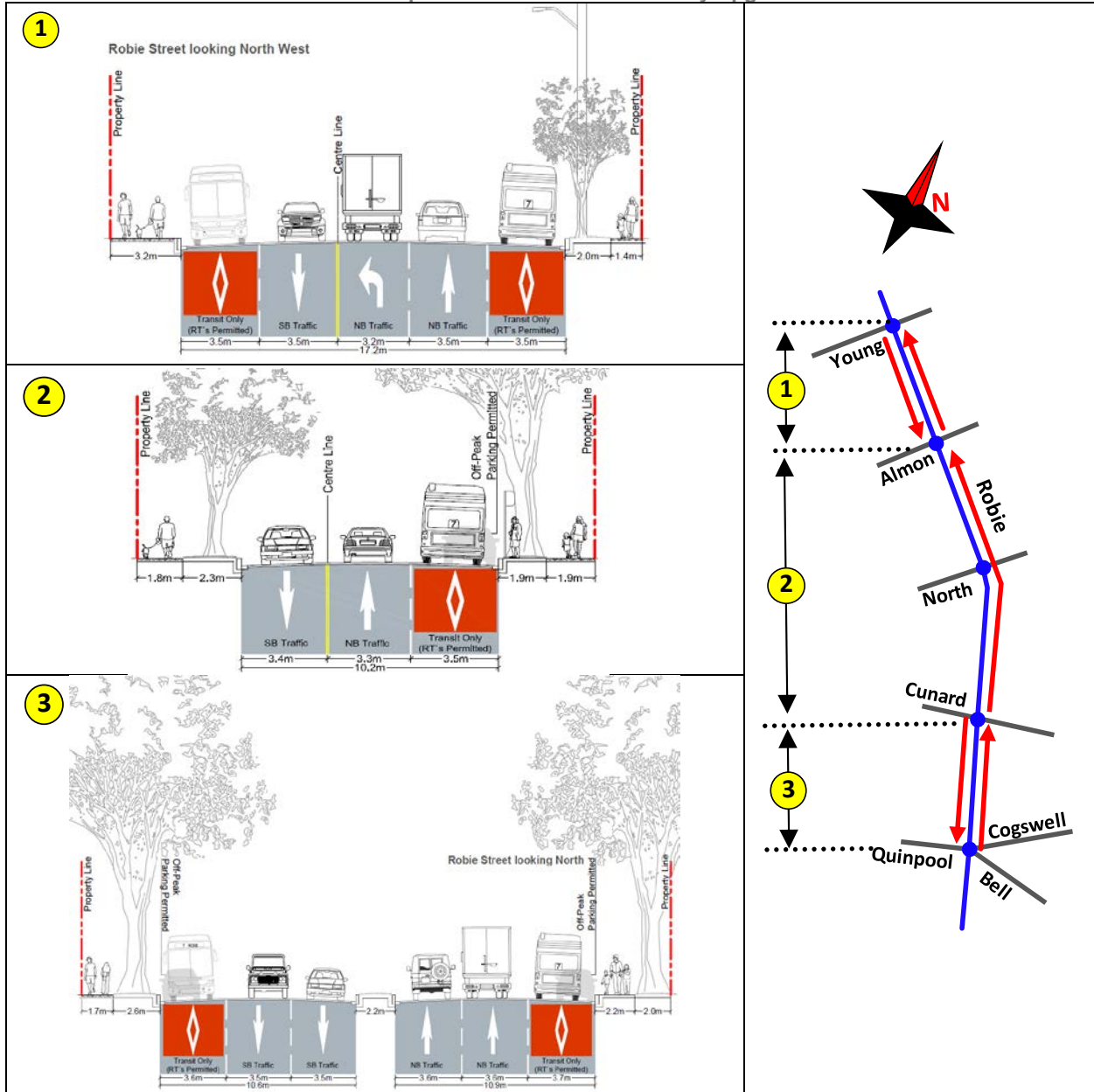

Parking and Loading Impacts

The number of parking spaces and “No Parking” (loading permitted) areas under existing and proposed conditions are summarized in Table 4.

- The proposed design will remove all 58 on-street parking spaces on Robie Street during periods when the transit lane is operational. The operational hours of the transit lane will dictate the full extent of how parking is impacted. Designating the bus lane as operational only during certain times (i.e. weekday peak periods) would eliminate all on-street parking during those peak periods but would provide the opportunity to retain on-street parking spaces (and loading areas) outside of these operational periods. This may be desirable given the relatively high demand for parking along some areas of the corridor.
- While there is potential that some of the lost parking on Robie Street could shift to adjacent side streets, it is noted that the amount of available parking on side streets may also be impacted within the next few years due to active transportation facilities that are being planned in the area.
- The two accessible parking spaces on Robie Street are available on Sundays only; therefore, they would not be impacted by the proposed weekday transit lane.

Table 4: Approximate Parking and Loading Inventory on Robie Street

| | | Parking Supply | | | Loading Permitted | |
|--------------------------------|------|----------------|-------------------|-------------------------|-------------------|------------------|
| | | Existing | Average Occupancy | Avg. Duration (Minutes) | Peak Periods | Off-Peak Periods |
| Almon Street to North Street | East | 20 | 54% | 158 | 125m | 195m |
| | West | 0 | - | - | 0 | 400m |
| North Street to Cunard Street | East | 2 | - | - | 115m | 380m |
| | West | 0 | - | - | 0 | 405m |
| Cunard Street to Quinpool Road | East | 23 | 93% | 380 | 250m | 250m |
| | West | 13 | 38% | 144 | 110m | 390m |
| Total | East | 45 | 75% | 275 | 490m | 825m |
| | West | 13 | 36% | 109.5 | 110m | 1195m |

Concluding Thoughts

Recognizing the importance of parking and loading activities on Robie Street, this on-street parking review has been prepared to develop a better understanding of parking / loading supply and demand along the corridor, and to review the impacts of the proposed design on both activities. In preparing the parking study, staff have completed an investigation of existing on-street parking and loading activities on Robie Street between Quinpool Road/Cogswell Street and Almon Street. The study includes a detailed parking / loading inventory, and parking utilization data.

The proposed design for the Robie Street transit lane will impact on-street parking and loading activities along the corridor. During the proposed operational hours of the transit lane, all on-street parking and loading on the east and west sides of the street will be prohibited. If there are periods when the transit lane is not operational (i.e. outside of peak periods), there is potential to retain parking and loading in its current configuration during those periods. Parking utilization observations on Robie Street suggest that parking occupancy is relatively high, with long average parking duration that exceeds current time restrictions.

Attachment E

HALIFAX

Robie Street / Young Street Transit Priority Corridors

Public Feedback Survey Summary

February-26-18

Robie Street

| | |
|---|-----|
| Total Participants: Shape Your City Online Survey | 601 |
|---|-----|

Robie Street

Attachment E

How often do you typically use Robie Street by each mode of transportation?

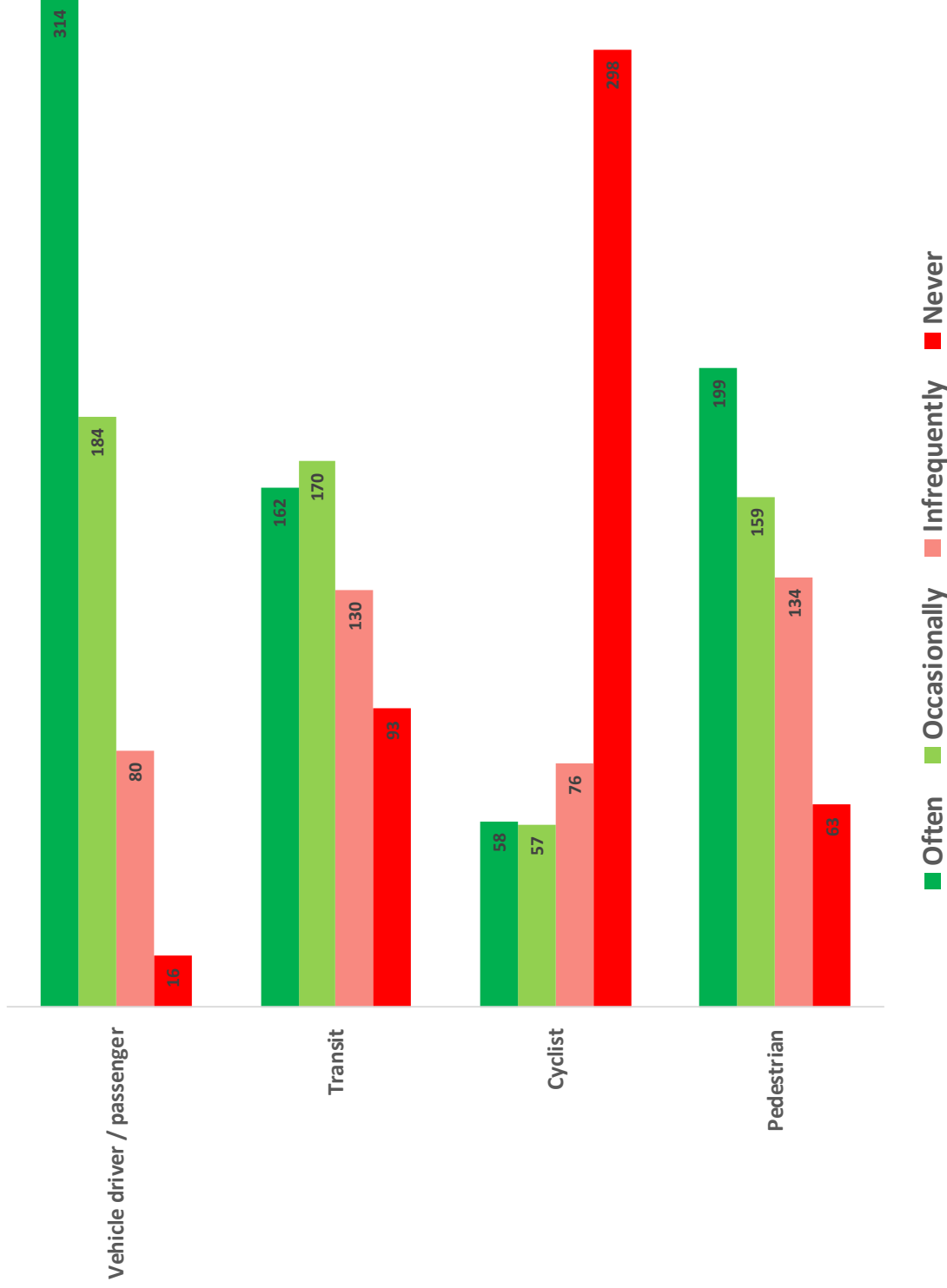

Robie Street

What matters most to you when you use Robie Street? (select up to 3)

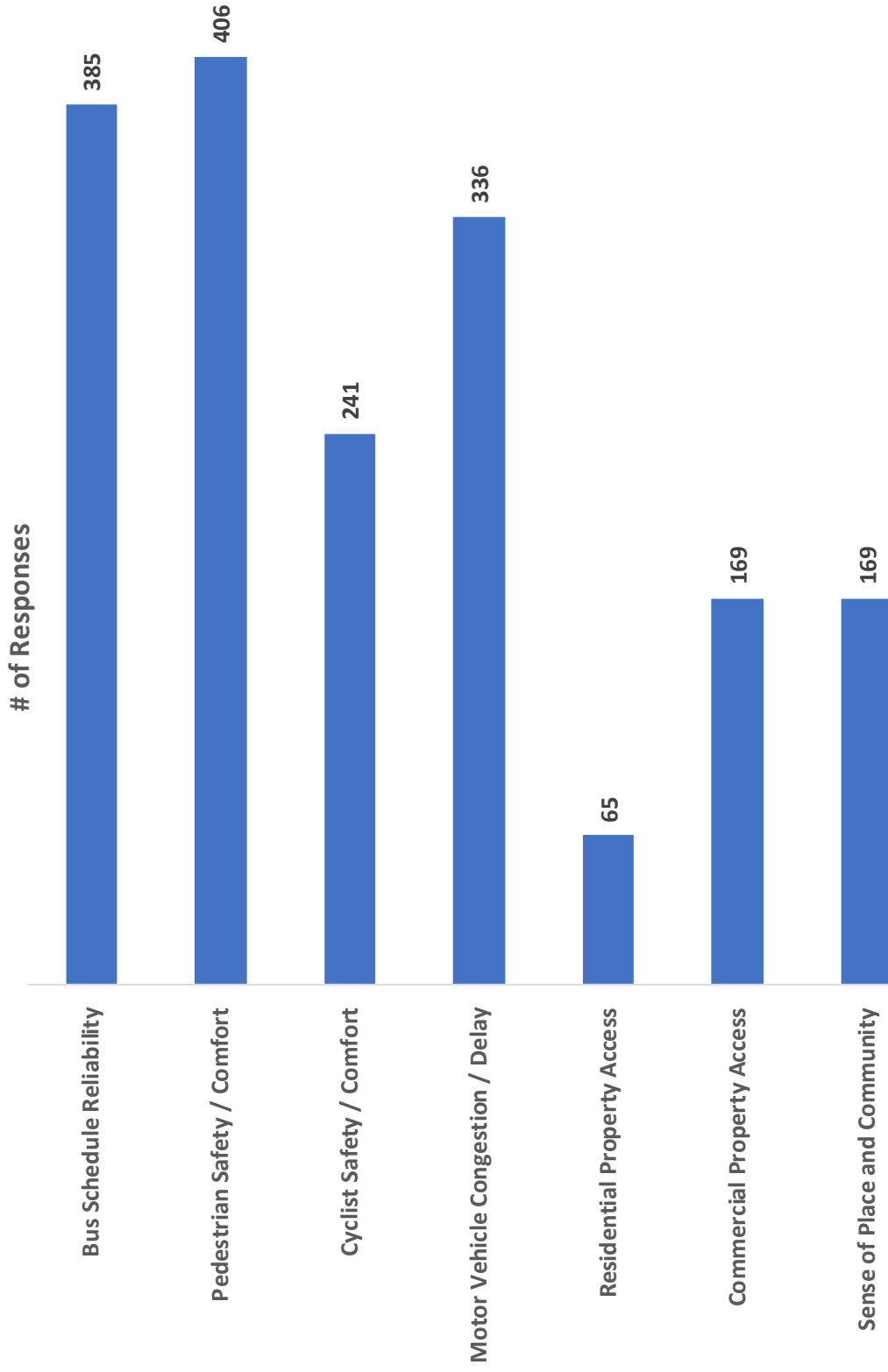

Robie Street

On a scale from 1-4 (where 1 is poor and four is excellent) how would you rate your experiences on Robie Street?

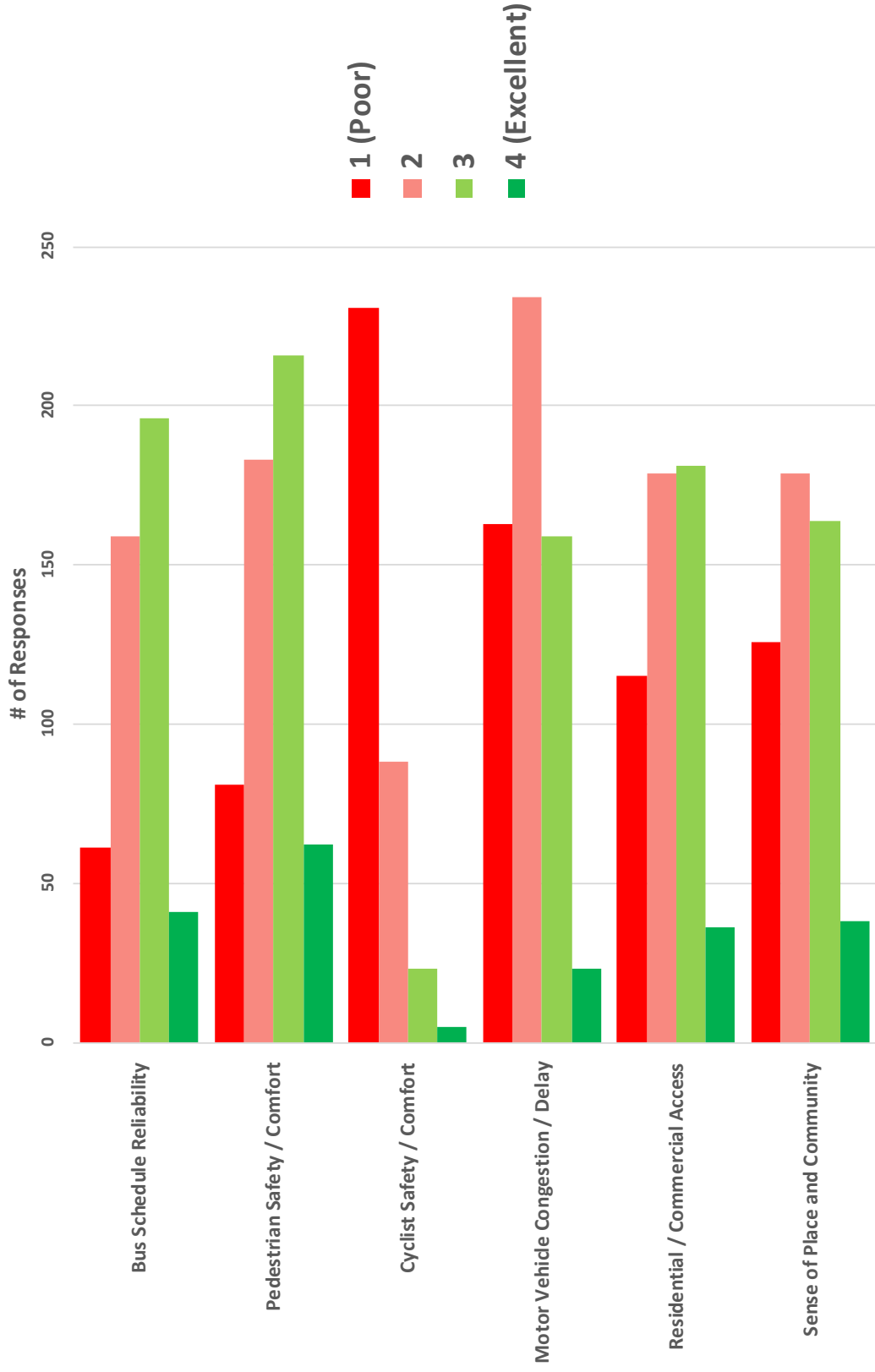

Robie Street

The addition of transit priority lanes on Robie Street may require trade-offs in some locations. How acceptable are the following potential trade-offs?

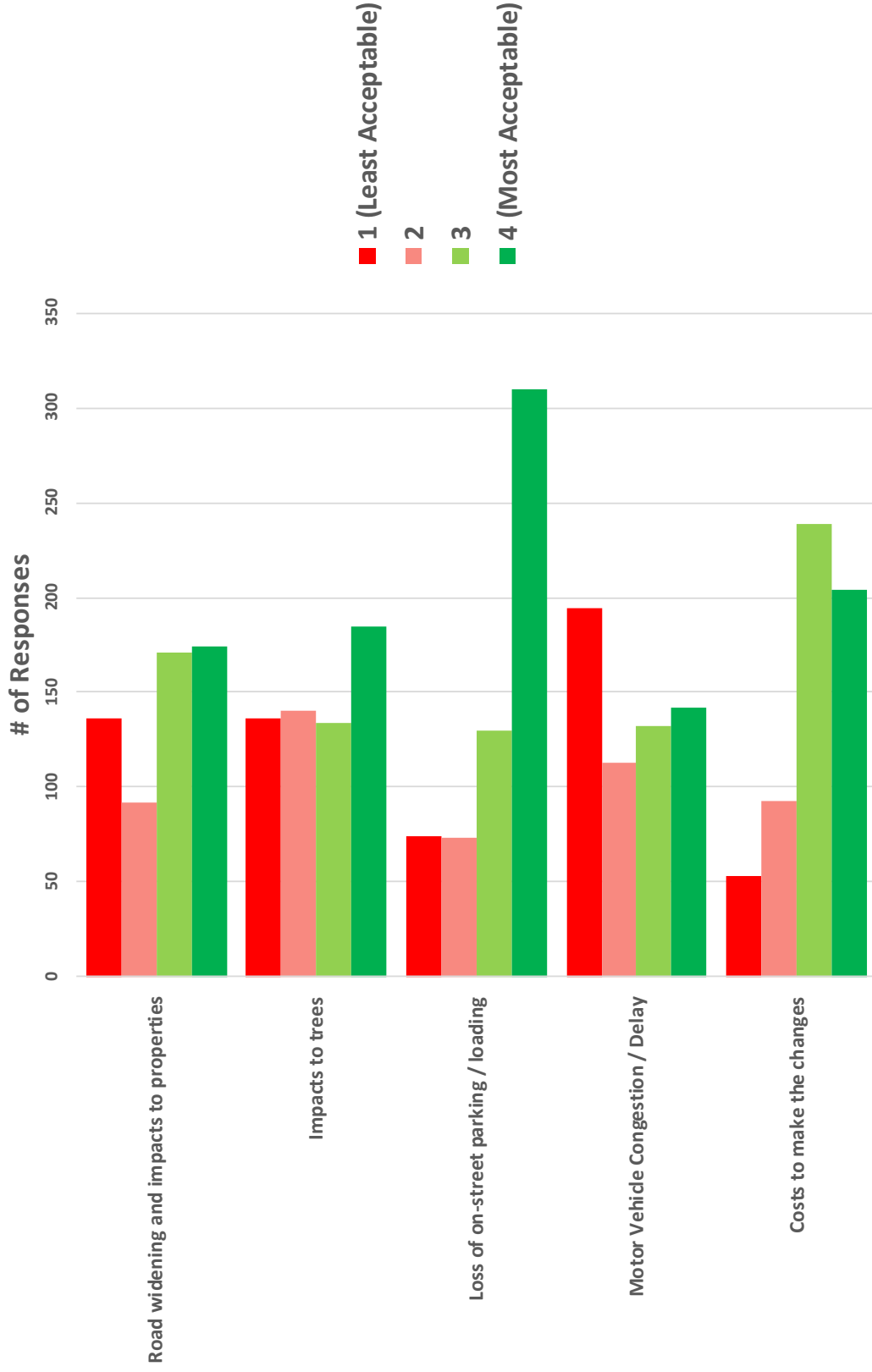

Robie Street

Attachment E

Indicate your preference based on the presented concepts

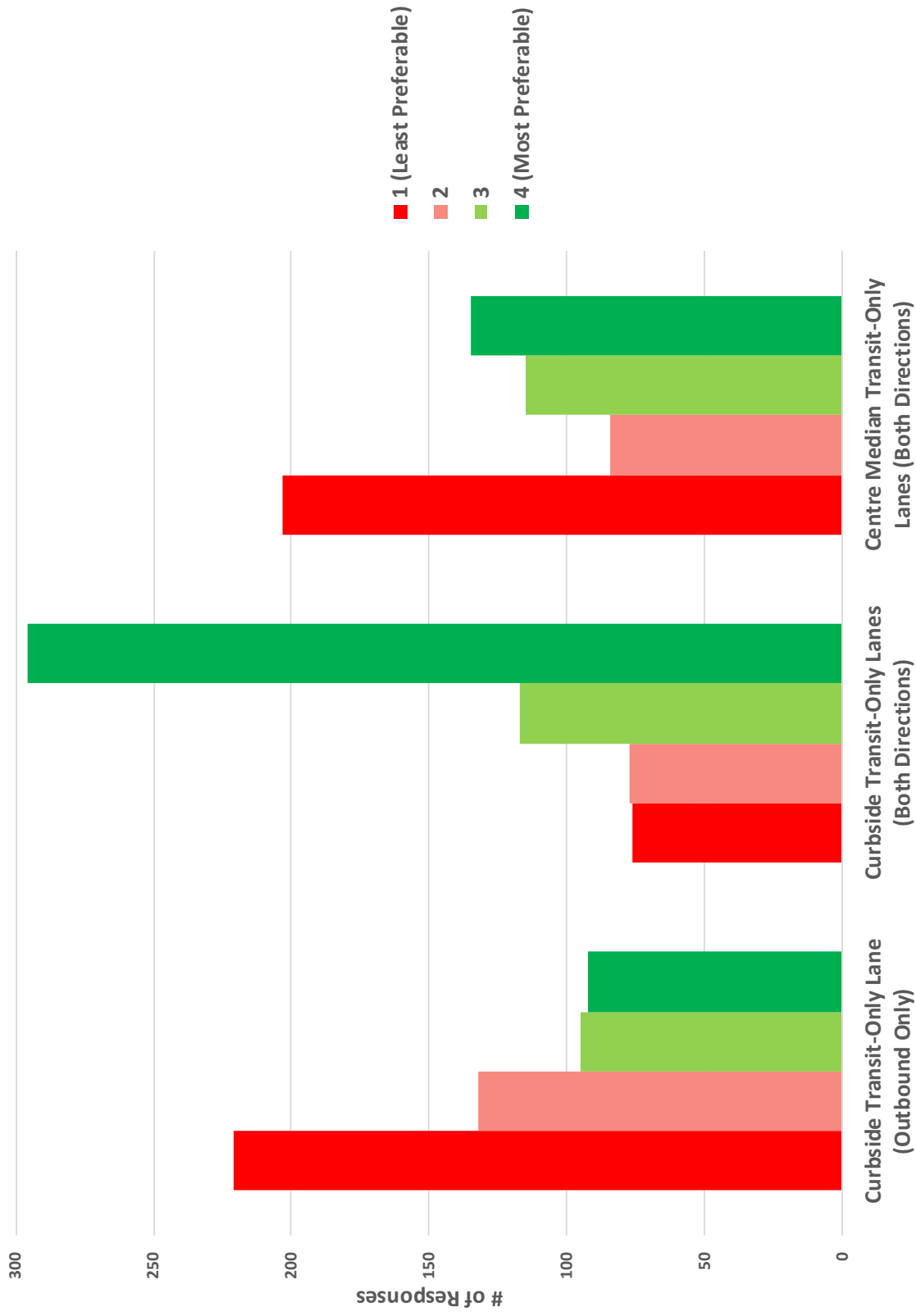

Young Street

| | |
|---|-----|
| Total Participants: Shape Your City Online Survey | 442 |
|---|-----|

Young Street

Attachment E

How often do you typically use Young Street by each mode of transportation?

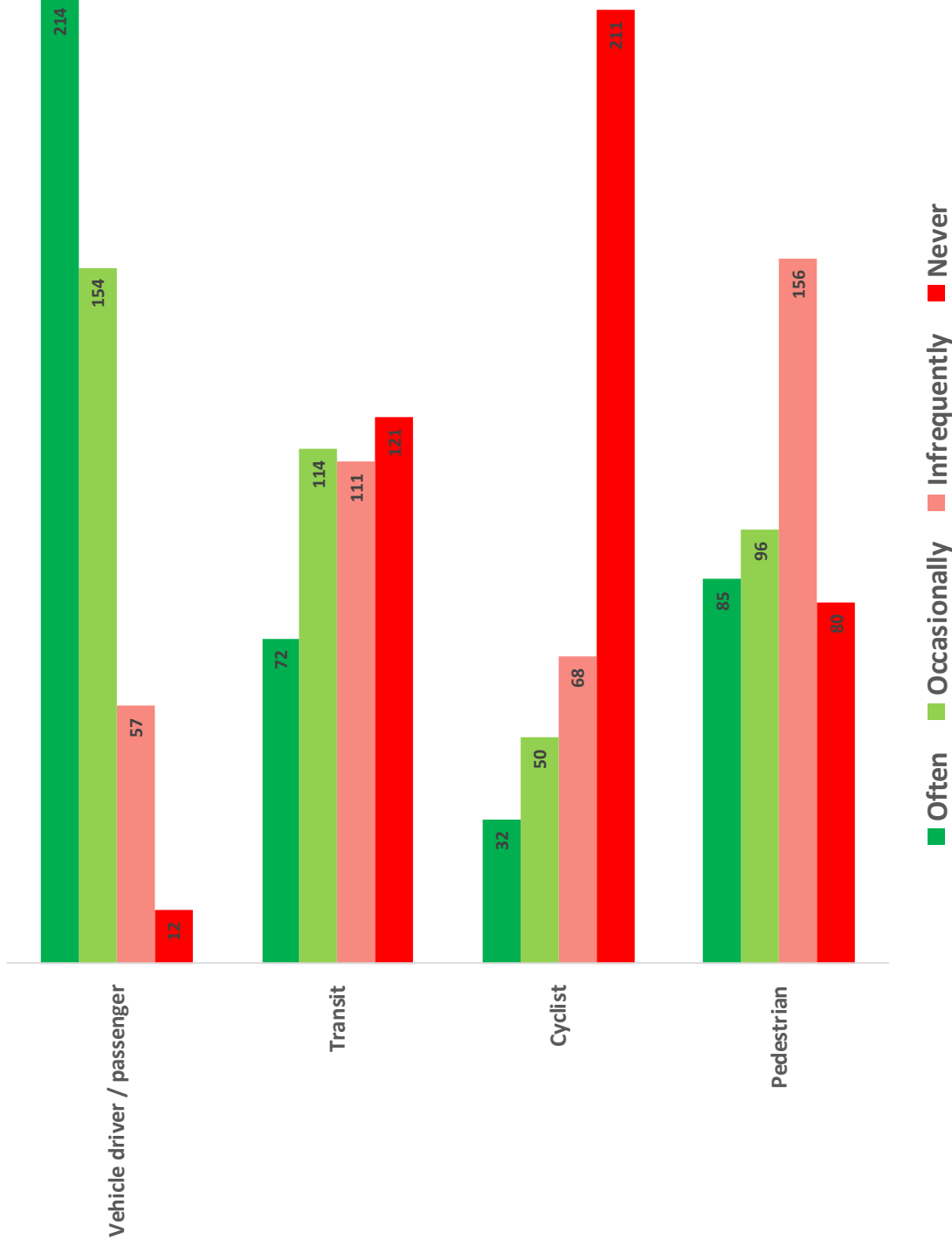

Young Street

What matters most to you when you use Young Street? (select up to 3)

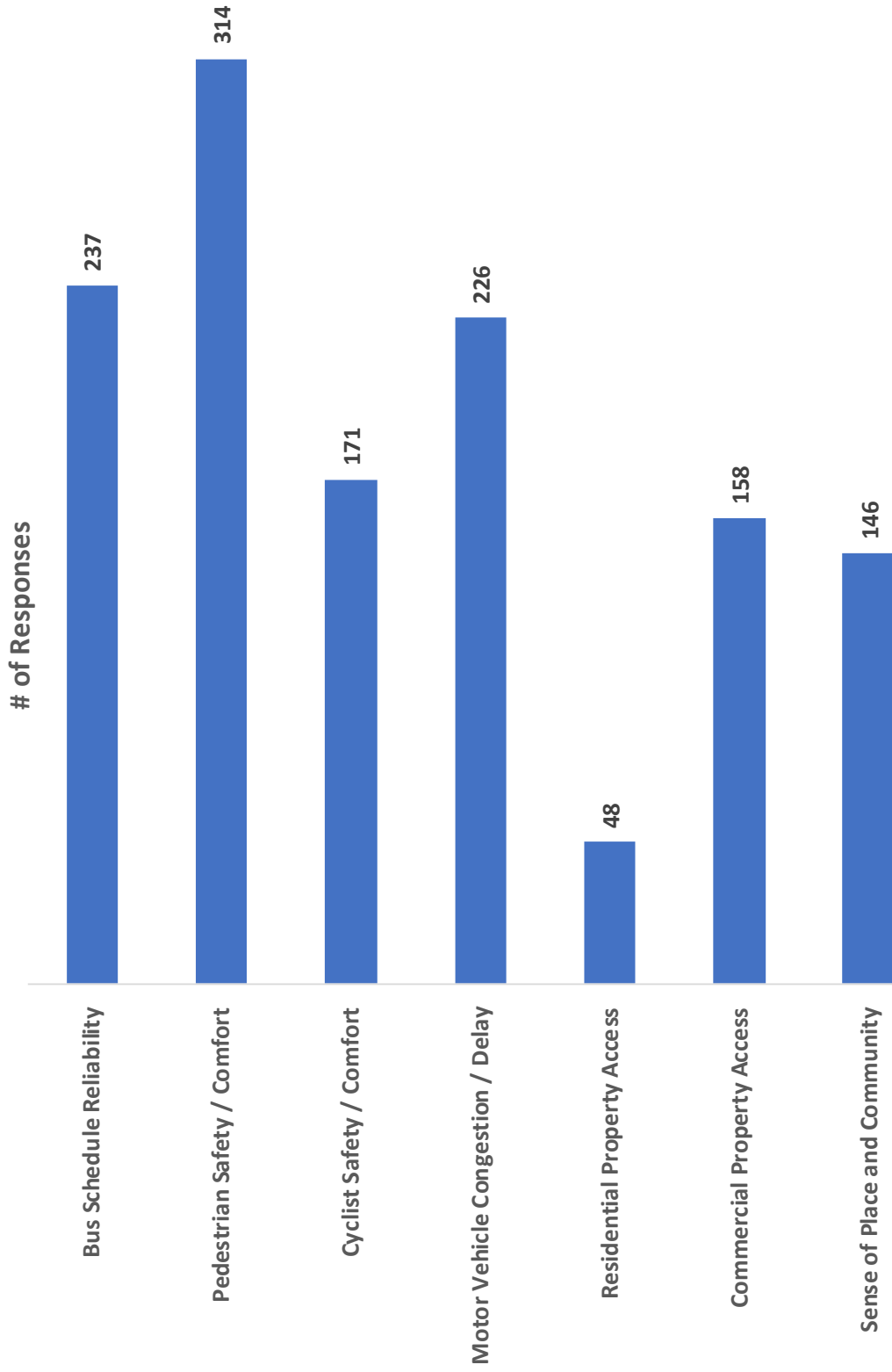

Young Street

On a scale from 1-4 (where 1 is poor and four is excellent) how would you rate your experiences on Young Street?

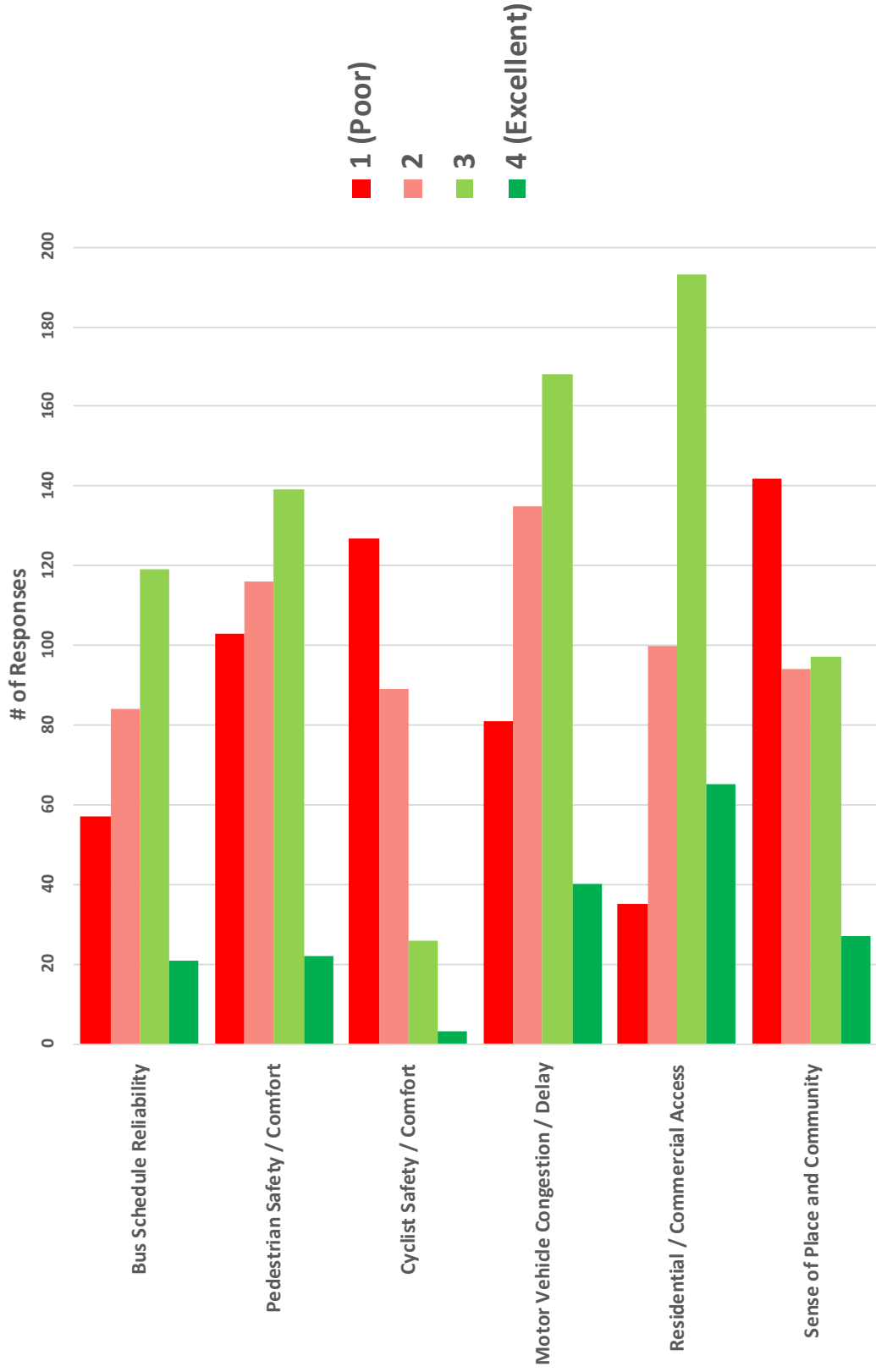

Young Street

The addition of transit priority lanes on Young Street may require trade-offs in some locations. How acceptable are the following potential trade-offs?

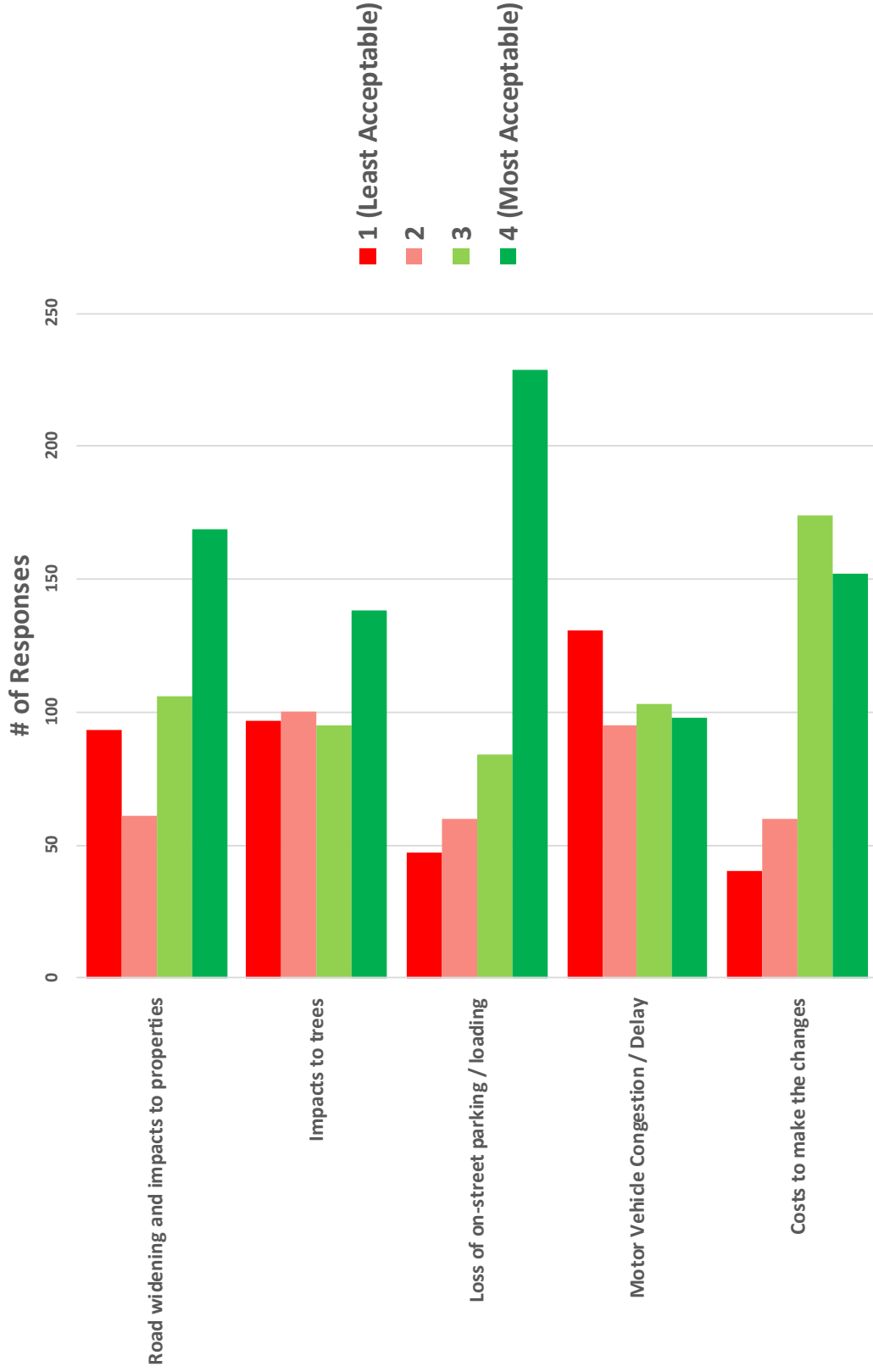

Young Street

Attachment E

Indicate your preference based on the presented concepts

